



**BRUTALE 800**  
**BRUTALE 800 RR**  
**BRUTALE 800 RC**  
**BRUTALE 800 PIRELLI**  
**BRUTALE 800 HAMILTON**

**USER'S MANUAL**  
**MANUALE DELL'UTENTE**

**BRUTALE  
8000-RR**

**MV AGUSTA**



Manuale dell'utente  
*Versione Italiana*

*Gentile cliente,*

*La ringraziamo per la fiducia accordataci e ci congratuliamo con Lei per la Sua nuova Brutale. MV Agusta, grazie alla passione e all'impegno dei suoi tecnici, si ripropone agli appassionati con un prodotto caratterizzato da una inedita veste estetica accostata ad una raffinata ciclistica: elementi che hanno contraddistinto tutte le creazioni del marchio MV Agusta nell'arco della sua gloriosa storia. Il risultato è una moto esclusiva che, per le sue caratteristiche estetiche e funzionali e le innumerovoli innovazioni tecniche, si pone al di sopra dei prodotti di più alto profilo che il mercato motociclistico possa oggi offrire.*

*Le soluzioni adottate conferiscono, infatti, alla Brutale quell'inconfondibile carattere che la lega agli altri modelli della famiglia MV Agusta, consolidando una filosofia progettuale che privilegia la costante ricerca, l'innovazione tecnologica e l'amore per il dettaglio dando la possibilità, a chi vive la propria passione motociclistica in piena libertà, di possedere un oggetto unico al mondo che si pone con prepotenza come riferimento di livello mondiale.*

*Se desiderasse ulteriori informazioni, non esiti a contattare il Servizio Assistenza Clienti MV Agusta.*

*Buon divertimento!*

*Giovanni Castiglioni  
Presidente  
MV Agusta*



## INDICE GENERALE

<i>cap.</i>	<i>Descrizione argomenti</i>	<i>pag.</i>	<i>cap.</i>	<i>Descrizione argomenti</i>	<i>pag.</i>
<b>1</b>	<b>INFORMAZIONI GENERALI</b>	<b>5</b>	<b>4</b>	<b>USO</b>	<b>31</b>
1.1.	Scopo del manuale	5	4.1.	Uso della motocicletta	31
1.2.	Simbologia	6	4.2.	Rodaggio	32
1.3.	Certificato di Consegna	7	4.3.	Avviamento motore	34
1.4.	Dati di identificazione	8	4.4.	Selezione e modifica delle funzioni display	37
<b>2</b>	<b>INFORMAZIONI SULLA SICUREZZA</b>	<b>11</b>	4.4.1.	Selezione funzioni display	38
2.1.	Garanzia del veicolo	11	4.4.2.	Azzeramento delle funzioni contachilometri parziali	43
2.2.	Manutenzione programmata	12	4.4.3.	Modalità "SPEED LIMITER"	45
2.3.	Carico veicolo	14	4.4.4.	Modalità TC	47
<b>3</b>	<b>COMANDI E STRUMENTI</b>	<b>15</b>	4.4.5.	Cronometro	48
3.1.	Posizione comandi e strumenti	15	4.4.6.	Selezione della funzione ABS	57
3.2.	Cavalletto laterale	17	4.4.7.	Modalità "QUICK SHIFT"	59
3.3.	Comandi al manubrio lato sinistro	18	4.4.8.	Impostazione dell'orologio	60
3.4.	Comandi al manubrio lato destro	20	4.4.9.	Funzione "IMMOBILIZER"	62
3.5.	Interruttore accensione e bloccasterzo	23	4.4.10.	Selezione della mappatura centralina	65
3.6.	Comando cambio	26	4.4.11.	Messaggi di errore/malfunzionamento	77
3.7.	Strumentazione e spie	27	4.5.	Rifornimento carburante	80
3.7.1.	Spie luminose di indicazione	28	4.6.	Rimozione sella passeggero	82
3.7.2.	Display multifunzione	29	4.7.	Rimozione sella pilota	83
3.8.	Tabella lubrificanti e liquidi	30	4.8.	Sosta della motocicletta	84



## INDICE GENERALE

<i>cap.</i>	<i>Descrizione argomenti</i>	<i>pag.</i>
<b>5</b>	<b>REGOLAZIONI</b>	<b>86</b>
5.1.	Elenco regolazioni	86
5.2.	Tabella delle regolazioni	89
5.3.	Regolazione leva freno anteriore	90
5.4.	Regolazione leva frizione	90
5.5.	Regolazione ammortizzatore di sterzo (Brutale RR)	91
5.6.	Regolazione specchietti retrovisori	92
5.7.	Regolazione sospensione anteriore	93
5.7.1.	Precarico molla (sospensione anteriore)	93
5.7.2.	Dispositivo idraulico di frenatura in estensione (sospensione anteriore)	94
5.7.3.	Dispositivo idraulico di frenatura in compressione (sospensione anteriore)	94
5.8.	Regolazione sospensione posteriore	95
5.8.1.	Dispositivo idraulico di frenatura in estensione (sospensione posteriore)	96
5.8.2.	Dispositivo idraulico di frenatura in compressione (sospensione posteriore)	96
5.9.	Regolazione proiettore anteriore	97



## 1.1. Scopo del manuale

Il presente Manuale fornisce le informazioni necessarie per un uso corretto e sicuro della moto.

Il Manuale viene fornito anche in formato elettronico (.pdf) sul presente supporto digitale e può essere stampato o visualizzato su un qualsiasi PC, sia dotato di sistema Windows che Mac.

Vi raccomandiamo di leggere attentamente il Manuale prima di utilizzare la moto e di sincerarVi che chiunque utilizzi la moto abbia prima fatto lo stesso.

Nel supporto digitale fornito in dotazione troverete, oltre a questo Manuale, il Manuale di Manutenzione, la Guida delle Concessionarie ed il Libretto di Garanzia.



Copyright  
MV AGUSTA Motor Spa  
Tutti i diritti riservati



## 1.2. Simbologia

Le parti di testo di particolare importanza, relative alla sicurezza della persona e all'integrità della motocicletta, sono evidenziate con i seguenti simboli:



**Pericolo - Attenzione:** la mancata o incompleta osservanza di queste prescrizioni può comportare pericolo grave per la propria incolumità e per quella di altre persone.



**Cautela - Precauzione:** la mancata o incompleta osservanza di queste prescrizioni può comportare un rischio di danni alla motocicletta.

Per indicare le persone autorizzate allo svolgimento delle operazioni di regolazione e/o manutenzione, esse sono contraddistinte dai seguenti simboli:



**Informazioni sulle operazioni consentite al motociclista.**



**Informazioni sulle operazioni che devono essere svolte solo dal personale autorizzato.**

Per evidenziare ulteriori informazioni vengono utilizzati i seguenti simboli:



Il simbolo  indica la necessità di utilizzare un attrezzo od un'attrezzatura specifica per il corretto svolgimento dell'operazione descritta.



Il simbolo “ § ” indica il rimando al capitolo identificato dal numero che lo segue.



### 1.3. Certificato di Consegna

Al momento della consegna della moto, il Vs. Concessionario vi ha consegnato il Certificato di Garanzia e Pre-Consegna.

Vi preghiamo di conservarlo unitamente ai documenti della moto ed ai futuri tagliandi di manutenzione che vi verranno via via consegnati in occasione degli interventi previsti.

#### **IMPORTANTE**

Le copie del Certificato di Garanzia e Pre-Consegna devono essere compilate dal Concessionario. Una copia deve essere consegnata al Cliente, una deve essere conservata dal Concessionario ed una deve essere inviata all'Importatore.

Le copie dei tagliandi di manutenzione raccomandata devono essere sempre compilati dal Concessionario. Esse devono essere conservate dal Cliente e dal Concessionario.





1

2) numero di matricola motore

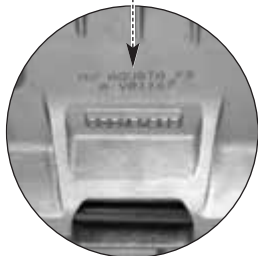

3) dati di omologazione

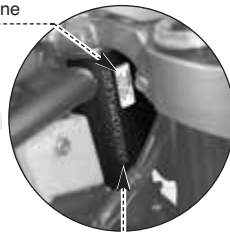

1) numero di matricola telaio

## 1.4. Dati di identificazione

- 1) numero di matricola telaio
- 2) numero di matricola motore
- 3) dati di omologazione

### ► Identificazione motocicletta

La motocicletta è identificata dal numero di matricola del telaio. Per ordinare le parti di ricambio, oltre a questo numero, può essere necessario indicare il numero di matricola motore, il codice colore e il numero di identificazione chiave.

Si consiglia di annotare i dati principali negli spazi sotto riportati.

**TELAIO N.:** \_\_\_\_\_

**MOTORE N.:** \_\_\_\_\_



## ► Identificazione chiave della motocicletta

Viene fornita, in duplice copia, una chiave da utilizzare sia per l'avviamento che per l'azionamento di tutte le serrature. Custodire in luogo sicuro la copia di scorta.

La conoscenza del numero di identificazione chiave è essenziale nel caso in cui si renda necessario richiedere un duplicato della chiave a ricambio. Il numero di identificazione chiave è riportato sulla MV Code Card fornita in dotazione insieme alle chiavi di avviamento.



# 1

## ► Identificazione combinazione colori motocicletta

Il codice colore è indispensabile per ordinare le parti di ricambio della carrozzeria. Esso si trova nella parte posteriore inferiore del serbatoio benzina.

Per accedere alla targhetta codice colore, è necessario rimuovere la sella passeggero e la sella pilota come descritto nei paragrafi §4.6 e §4.7.





1

Dopo avere rimosso le selle, è possibile accedere alla targhetta codice colore posta sul serbatoio. Su questa targhetta è possibile individuare il codice colore della motocicletta, il quale determina la colorazione delle parti della carrozzeria.

Si consiglia di annotare il codice colore della motocicletta nel seguente spazio:

**CODICE COLORE :** .....

Per conoscere i colori di riferimento delle parti verniciate in base al codice colore della motocicletta, consultare il Manuale di Manutenzione presente sul supporto digitale fornito in dotazione.

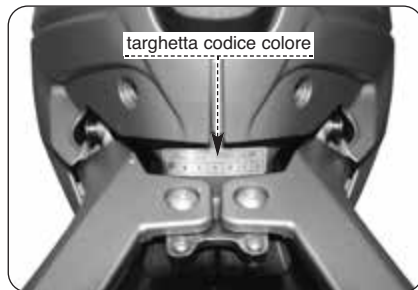



## 2.1. GARANZIA DEL VEICOLO



### ATTENZIONE

Le ricordiamo che la garanzia non opera nel caso di uso del veicolo in competizioni motociclistiche, che si svolgano sia in pista o su strada pubblica, in quanto trattasi di uso diverso e non compatibile con l'uso su strada per il quale il suo veicolo è stato specificatamente progettato.

Inoltre, la garanzia non opera nel caso in cui il veicolo venga utilizzato per attività professionali quali, a titolo esemplificativo ma non esaustivo, servizio taxi, noleggio, etc.

La avvertiamo, altresì, che MV Agusta si riserva di valutare l'operatività della garanzia in tutti i casi, nessuno escluso, in cui venisse accertato che il suo veicolo è stato modificato rispetto alla sua configurazione originale e ciò anche

con parti di ricambio e/o accessori originali MV Agusta e montati dal Servizio di Assistenza Tecnica presso un Concessionario MV Agusta.

Le evidenziamo, inoltre, che la garanzia non opera nel caso in cui ogni intervento, sia che si tratti di Tagliandi di Manutenzione che di qualsivoglia altro intervento di riparazione, settaggio, sostituzione od altro tipo di intervento, venga effettuato da officine e/o da tecnici e/o da centri di assistenza e riparazione e, in generale, da qualsiasi terzo che non abbia operato secondo gli standard tecnici e procedurali che MV mette a disposizione del personale tecnico qualificato alla corretta manutenzione del veicolo (corsi tecnici; attrezzatura specifica officina; manualistica; ricambi originali; ecc) di MV Agusta e/o non abbia utilizzato parti di ricambio e/o accessori originali MV Agusta.



In ogni caso, Le precisiamo che la garanzia non copre le parti soggette a usura o deterioramento (lubrificanti e liquidi vari, candele, frizione, filtri, catena, corona, pignone, pastiglie freni, dischi freno, pneumatici, tubazioni e parti in gomma, batteria, lampadine e fusibili) eventi da imperizia e/o incuria e/o da esposizione da agenti atmosferici (sbiadimenti vernice, corrosioni, etc...) e/o da superamento dei limiti di carico previsti nel Manuale d'Uso del veicolo.

Si ricordi che, come richiesto dalla Legge, questa garanzia è prestata direttamente dal Suo Concessionario MV Agusta al quale La invitiamo a rivolgersi per ogni necessità del caso ed è operativa, anche all'estero, presso qualsiasi altro Concessionario della rete MV Agusta.

## 2.2. MANUTENZIONE PROGRAMMATA



### ATTENZIONE

La avvertiamo che nel caso in cui il suo veicolo manifesti rotture o malfunzionamenti dovuti alla mancata esecuzione dei tagliandi di manutenzione, il Suo Concessionario potrà rifiutarsi di intervenire in garanzia e nel contempo lo stesso Concessionario e MV Agusta S.p.A. non potranno essere considerati responsabili per eventuali danni subiti dal veicolo e/o dall'utilizzatore e/o da terzi e/o a cose di terzi, a causa delle suddette rotture o malfunzionamenti.

Tutti i Tagliandi di manutenzione, compreso quello iniziale sono a pagamento, sia come materiale che come mano d'opera.

La MV Agusta Le raccomanda che ogni intervento sul veicolo, sia che si tratti di Tagliandi di Manutenzione che di qualsivoglia altro intervento



di riparazione, settaggio, sostituzione od altro tipo di intervento venga eseguito presso le officine autorizzate dei Concessionari MV Agusta secondo le modalità esposte nel Manuale di Manutenzione, nel Manuale di Officina ed in eventuali Circolari Tecniche pubblicate dalla MV Agusta S.p.A. in quanto MV Agusta garantisce la corretta esecuzione di ogni intervento solo ed esclusivamente se effettuato presso le officine autorizzate dei Concessionari MV Agusta che operano secondo gli standard tecnici e procedurali di MV Agusta e utilizzano esclusivamente parti di ricambio e accessori originali.

Dopo ogni Tagliando di Manutenzione obbligatorio verifichi sempre che il relativo tagliando sia timbrato e sottoscritto dal Concessionario e verifichi che l'intervento effettuato risponda alle Sue aspettative.

Troverà i Tagliandi suddetti in calce al Libretto di Garanzia.

Conservi sempre il Libretto di Garanzia contenente i tagliandi timbrati dal concessionario MV Agusta e le relative ricevute fiscali, ed in caso di cessione del veicolo, lo consegni al nuovo acquirente.

2

### Scadenze degli interventi di manutenzione programmata

Frequenza Km (mi)*	1000 (600)	Ogni anno	15000 (9000)	30000 (18000)	45000 (27000)	60000 (36000)	75000 (45000)	90000 (54000)	105000 (63000)
Tagliando	A		B	C	D	E	F	G	H

(\*): I tagliandi chilometrici possono essere effettuati congiuntamente con il tagliando annuale **obbligatorio**



### 2.3. CARICO VEICOLO

Il veicolo è progettato per l'impiego da parte del pilota e di un eventuale passeggero.

Per un utilizzo in piena sicurezza e nel rispetto delle norme del codice stradale è obbligatorio non superare mai la massa massima tecnicamente ammissibile del veicolo, il cui valore è di seguito riportato:

#### BRUTALE 800 - RR

Massa massima tecnicamente ammissibile  
**379 kg**

Massa massima trasportabile  
**180 kg**

La massa massima tecnicamente ammissibile rappresenta la somma delle seguenti masse:

- massa del motociclo;
- massa del pilota;
- massa del passeggero;
- massa del bagaglio e degli accessori.



#### ATTENZIONE

Dato che il carico ha un impatto enorme sulla manovrabilità, la frenata, le prestazioni e le caratteristiche di sicurezza del vostro mezzo, tenere sempre presenti le seguenti precauzioni.

- **NON SOVRACCARICARE MAI IL MOTOCICLO!** L'uso di un motociclo sovraccaricato può provocare danneggiamenti dei pneumatici, perdite del controllo o infortuni gravi. Verificare che il peso totale del pilota, del passeggero, del carico e degli accessori non superi il carico massimo specificato per il motociclo.



## 3.1. Posizione comandi e strumenti

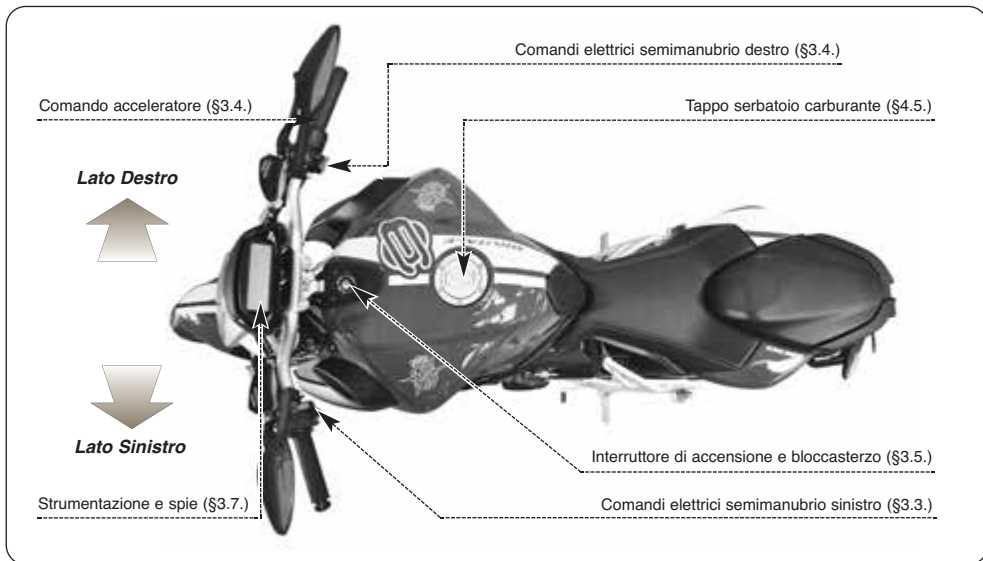





3

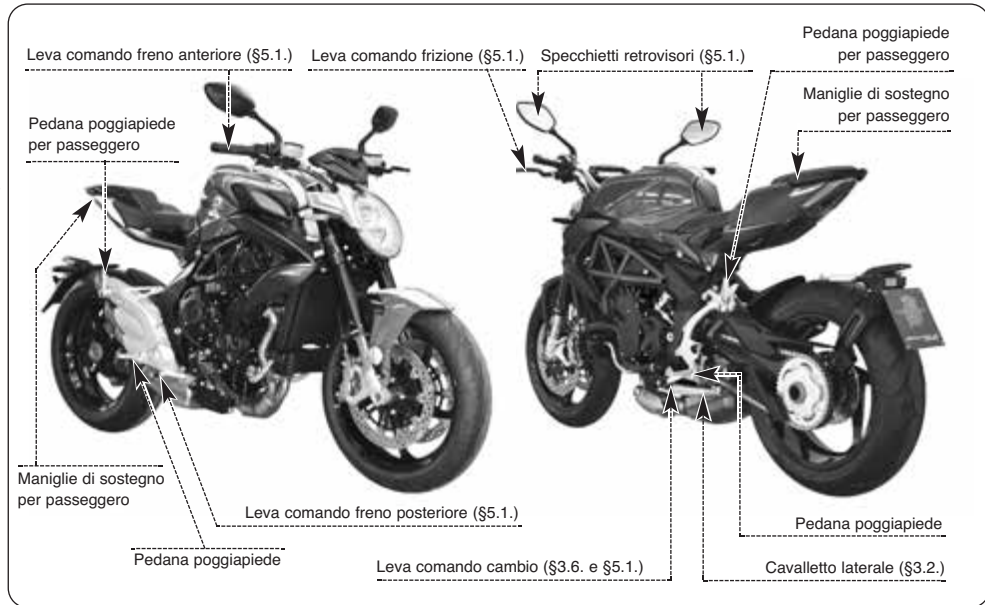



### 3.2. Cavalletto laterale

Il cavalletto laterale è dotato di un interruttore di sicurezza che impedisce la partenza con il cavalletto abbassato.

Nel caso in cui a motore avviato e nella condizione di cavalletto abbassato si azioni il cambio per porsi in movimento, l'interruttore interrompe la corrente al motore provocandone l'arresto.

Nel caso in cui la moto si trovi invece in condizione di stazionamento (cavalletto abbassato) e con un rapporto del cambio inserito, l'interruttore impedisce l'avviamento del motore evitando ogni rischio di caduta accidentale del veicolo.





### 3.3. Comandi al manubrio lato sinistro

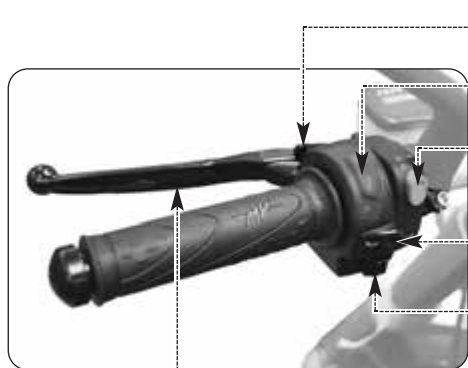

#### **Pulsante lampeggio fari**

Premere il pulsante a ripetizione.

#### **Pulsante SET/OK**

Premere per modificare le funzioni del cruscotto (§ 4.4).

#### **Pulsante abbagliante/anabbagliante**

Pulsante in fuori  : anabbagliante 

Pulsante in dentro  : abbagliante 

#### **Pulsante avvisatore acustico**

Premere per attivare l'avvisatore acustico.

#### **Leva indicatori di direzione**

Spostando la leva a destra o a sinistra si attivano gli indicatori di direzione destri o sinistri. La leva torna al centro; premere per disattivare gli indicatori.

#### **Leva frizione**

Accostare o allontanare dalla manopola per comandare la frizione.



### **Pulsante Lampeggio Faro**

Questa funzione serve a richiamare l'attenzione degli altri utenti della strada in caso di possibili situazioni di pericolo; con l'abbagliante acceso tale funzione non è attiva.

### **Pulsante SET/OK**

Il pulsante SET consente di selezionare le varie funzioni del display per effettuare le regolazioni, mentre il pulsante OK consente di confermare i valori impostati.

### **Pulsante Abbagliante/Anabbagliante**

Normalmente viene attivata la funzione anabbagliante; quando le condizioni di traffico e di percorso lo consentono, può essere attivata la funzione abbagliante agendo sul pulsante.

### **Pulsante Avvisatore Acustico**

Questa funzione serve a richiamare l'attenzione degli altri utenti della strada in caso di possibili situazioni di pericolo.

### **Leva Indicatori di Direzione**

Questa funzione permette di segnalare agli altri utenti della strada l'intenzione di cambiare direzione o corsia di marcia.



#### **ATTENZIONE**

**Il mancato uso o la mancata disattivazione degli indicatori di direzione al momento opportuno può essere causa di incidenti; gli altri utenti della strada potrebbero infatti trarre conclusioni sbagliate riguardo all'effettivo tragitto del veicolo. Azionare sempre gli indicatori di direzione prima di svoltare o cambiare corsia. Accertarsi poi di disattivare gli indicatori non appena effettuata la suddetta manovra.**

### **Leva Frizione**

Questa leva consente l'innesto ed il disinnesto della frizione.



### 3.4. Comandi al manubrio lato destro

#### Pulsante luci di emergenza

Premere per attivare o disattivare le luci di emergenza.

#### Pulsante “Engine Map”

Premere per selezionare la mappatura centralina (§4.4.10.).

#### Interruttore stop motore

Se azionato arresta il motore e ne impedisce l'avviamento.

#### Pulsante avviamento motore

Premuto avvia il motore. Va rilasciato appena avviato.

#### Comando acceleratore

Ruotare per regolare l'alimentazione del motore.

#### Leva luci notturne / luci diurne (DRL) \*

Spostando la leva in alto o in basso si attivano le luci notturne (faro abbagliante/anabbagliante) o le luci di posizione diurne (Day Running Lights).

#### Leva freno anteriore

Avvicinare alla manopola per azionare il freno anteriore.

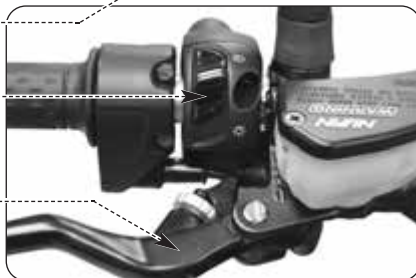
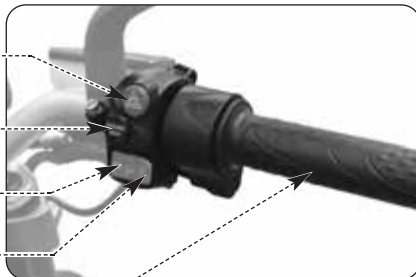

(\*): Funzione non presente sulle versioni Giappone e Australia



### **Pulsante Luci di Emergenza**

Questa funzione serve a richiamare l'attenzione degli altri utenti della strada in caso di possibili situazioni di pericolo.

### **Pulsante “Engine Map”**

Questo pulsante consente di selezionare automaticamente la mappatura della centralina (vedi §4.4.10).

### **Interruttore Stop Motore**

Questa funzione permette di arrestare il motore; in questo modo viene disattivato il circuito di accensione impedendo il riavvio del motore. Per poter effettuare l'avviamento riportare il pulsante in posizione di riposo.

**NOTA: In condizioni normali, utilizzare questo dispositivo per l'arresto del motore.**

### **Pulsante Avviamento Motore**

Questo dispositivo consente l'avviamento del motore; inoltre a motore avviato esso permette di selezionare le funzioni del display presente nella strumentazione di bordo.



**CAUTELA: Per evitare danni all'impianto elettrico non tenere premuto il pulsante per un tempo superiore ai 5 secondi consecutivi. Se il motore non si avvia dopo alcuni tentativi, consultare il capitolo “GUASTI” nel “Manuale di Manutenzione”.**

### **Comando Acceleratore**

Questo dispositivo consente di regolare l'alimentazione del motore variandone così il regime di rotazione. Per azionare il dispositivo occorre ruotare la manopola dalla posizione di riposo, corrispondente alla condizione di regime minimo del motore.



**ATTENZIONE: Nel caso in cui la Vostra motocicletta sia caduta o sia rimasta coinvolta in un incidente, fare controllare la funzionalità del comando acceleratore presso un centro assistenza autorizzato MV Agusta prima di riprendere la marcia.**



### Leva Luci Notturne / Luci Diurne (DRL) \*

Questo dispositivo consente di attivare alternativamente i dispositivi di illuminazione diurni (Day Running Lights) o notturni (faro abbagliante / anabbagliante - vedi §3.3), a seconda delle condizioni di luce esterne.

### Leva Freno Anteriore

Questo comando permette di azionare attraverso un circuito idraulico l'impianto frenante della ruota anteriore.

### ☐ Sistema antibloccaggio ABS

I modelli Brutale sono equipaggiati con un sistema di frenatura servoassistito ABS ("Antilock Braking System"), che impedisce il bloccaggio delle ruote durante le frenate di emergenza garantendo la stabilità del veicolo e riducendo gli spazi di arresto.



**ATTENZIONE:** Nel momento in cui il sistema ABS entra in funzione, è possibile avvertire delle vibrazioni sulla leva o sul pedale del freno. In tal caso si raccomanda di mantenere la pressione sui dispositivi di azionamento dei freni per permettere al veicolo di completare l'operazione di arresto.



**ATTENZIONE:** Un eventuale malfunzionamento o la disattivazione del sistema ABS vengono segnalati dall'accensione dell'apposita spia presente sul cruscotto (vedi § 3.7.1.). Nel momento in cui la spia si accende, la funzione antibloccaggio potrebbe non essere più disponibile. In caso di anomalia, si raccomanda di proseguire la marcia a velocità ridotta e contattare un centro assistenza autorizzato MV Agusta. In caso di disattivazione, procedere con la selezione della funzione ABS (vedi § 4.4.6.).

*(\*): Funzione non presente sulle versioni Giappone e Australia*



### 3.5. Interruttore accensione e bloccasterzo



**ATTENZIONE:** Non applicare portachiavi o altri oggetti alla chiave di accensione per non creare ostacoli alla rotazione dello sterzo.



**ATTENZIONE:** Non tentare di cambiare alcuna funzione dell'interruttore durante la marcia; si potrebbe incorrere nella perdita di controllo del mezzo.

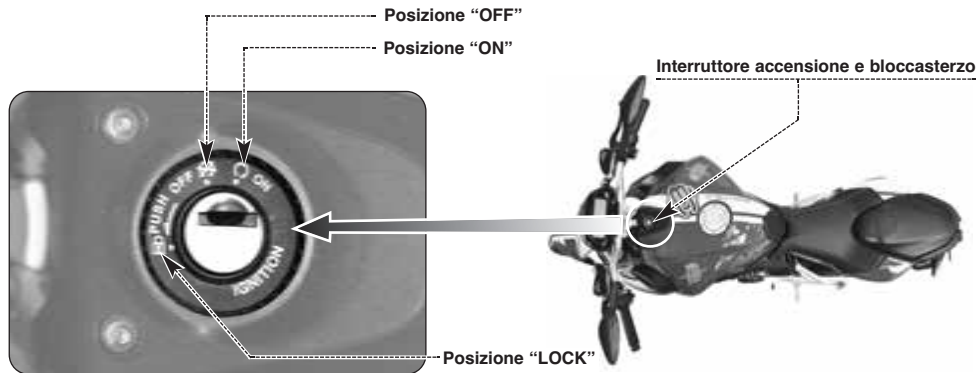





L'interruttore di accensione attiva e disattiva il circuito elettrico ed il bloccasterzo; le quattro posizioni di comando sono di seguito descritte.

### Posizione "OFF"

Tutti i circuiti elettrici sono disattivati. La chiave può essere estratta.

### Posizione "ON"

Tutti i circuiti elettrici sono attivati, la strumentazione e le spie eseguono l'autodiagnosi; il motore può essere avviato. La chiave non può essere estratta.



**Cautela-Precauzione:** Non lasciare la chiave sulla posizione "ON" a motore spento per lungo tempo, allo scopo di evitare il danneggiamento dei componenti elettrici della motocicletta.



### Posizione "LOCK"

Ruotare il manubrio a sinistra. Premere leggermente la chiave e contemporaneamente ruotarla in posizione "LOCK".

Tutti i circuiti elettrici sono disattivati e lo sterzo è bloccato. La chiave può essere estratta.





### 3.6. Comando cambio

La posizione **N** “Neutral” corrisponde alla posizione di folle segnalata dalla relativa spia cruscotto.

Spostando la leva del cambio verso il basso si innesta la prima marcia.

Analogamente, spostando la leva verso l’alto si innesta la seconda marcia; continuando più volte a spostare la leva verso l’alto si innestano, in modo sequenziale, tutte le altre marce fino alla sesta.



#### ☐ Funzione “Quick Shift”

I modelli Brutale sono equipaggiati con un sistema di cambio rapido (“Quick Shift”), che permette di aumentare o diminuire il rapporto di marcia senza tirare la leva frizione né agire sul comando acceleratore. In questo modo, è possibile innestare una marcia superiore o inferiore mantenendo costante l’accelerazione e riducendo al minimo il tempo di variazione del rapporto.



**ATTENZIONE:** Il sistema “Quick Shift” non è disponibile nelle seguenti condizioni:

- quando si cambia rapporto con la leva frizione tirata;
- quando il veicolo si trova ad una velocità inferiore a 30 km/h;
- quando la leva non si trova nella corretta posizione iniziale al momento di cambiare marcia.

Inoltre, quando si guida il veicolo utilizzando una marcia bassa ad un elevato numero di giri motore, cambiare rapporto senza utilizzare la leva frizione può causare brusche reazioni del veicolo che possono comprometterne la stabilità. MV Agusta consiglia di utilizzare la leva frizione in tutte le circostanze sopra citate, in particolare quando il numero di giri del motore si avvicina al regime di intervento del limitatore.



### 3.7. Strumentazione e spie

Gli strumenti e le spie si attivano ruotando la chiave di accensione in posizione "ON". Dopo un check-up iniziale (~ 7 secondi) le informazioni corrispondono alle condizioni generali della motocicletta in quel momento.





### 3.7.1. Spie luminose di indicazione

#### Spia ABS (rosso)

Si accende quando il sistema ABS è disattivato, quando si verifica un malfunzionamento oppure a velocità inferiori a 5 km/h.



**Pericolo - Attenzione:** Se si accende durante l'uso del veicolo, fermarsi immediatamente e verificare che la funzione ABS sia attivata (vedi §4.4.6.). In caso positivo, proseguire la marcia a velocità ridotta e contattare un centro assistenza autorizzato MV Agusta.

#### Spia luce abbagliante (blu)

Si accende quando è attivata la luce abbagliante.

#### Spia motore (giallo)

Si accende quando si verifica un malfunzionamento del motore.

#### Spia riserva carburante (arancio)

Si accende quando nel serbatoio sono contenuti circa 4 litri di carburante.

#### Spia cambio in folle (verde)

Si accende quando il cambio è nella posizione folle "Neutral".

#### Spia apertura cavalletto laterale (rosso)

Si accende quando il cavalletto è abbassato.

#### Spia pressione olio motore (rosso)

Si accende quando l'olio è ad una pressione insufficiente.



**Pericolo - Attenzione:** Se si accende durante la marcia, fermarsi immediatamente, controllare il livello dell'olio e se necessario farne effettuare il rabbocco

presso un centro assistenza autorizzato MV Agusta (vedi §3.8). Se la spia si accende nonostante il livello sia corretto, non proseguire la marcia e contattare un centro assistenza autorizzato MV Agusta.

#### Spie indicatori di direzione (verde)

Si accendono quando sono attivati gli indicatori di direzione.

#### Spia limitatore giri (rosso)

Si accende prima dell'intervento del limitatore, ad un numero di giri dipendente dal rapporto del cambio inserito. Il limitatore interviene a 13000 rpm.

#### Spia "Warning" (arancio)

Si accende quando si verifica un guasto. Se l'accensione avviene durante la marcia, rivolgersi ad un centro assistenza autorizzato.

#### Spia carica batteria (rosso)

Si accende quando l'alternatore non fornisce la corrente elettrica sufficiente a caricare la batteria.

Se l'accensione avviene durante la marcia, rivolgersi ad un centro assistenza autorizzato.

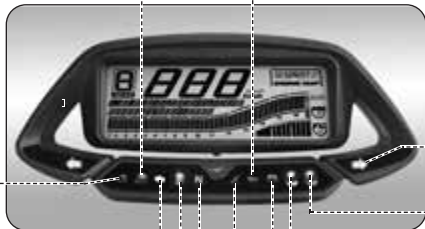



### 3.7.2. Display multifunzione

#### Tachimetro

Indica la velocità. Il valore può apparire in chilometri orari (Km/h) oppure in miglia orarie (Mph). Il valore a fondo scala è di 300 Km/h (186 Mph).

#### Display rapporto cambio

Indica il rapporto del cambio attualmente inserito. La posizione di folle è indicata con il numero "0".

#### Contachilometri totale "TOTAL"

Indica la percorrenza totale; da 0 a 999999 (Km o mi)

#### Contachilometri parziale 1 "TRIP 1"

Indica la percorrenza parziale; da 0 a 999.9 (Km o mi)

#### Contachilometri parziale 2 "TRIP 2"

Indica la percorrenza parziale; da 0 a 999.9 (Km o mi)

#### Cronometro

Indica i tempi misurati con la funzione cronometro

#### Display ABS

Indica lo stato di attivazione della funzione ABS.

#### Display livello controllo di trazione

Indica il livello del controllo di trazione attualmente selezionato.

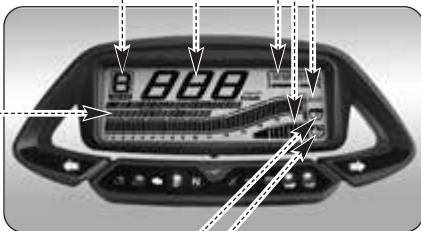

#### Display mappatura centralina

Indica la mappatura centralina attualmente selezionata.

#### Orologio

Indica l'orario attuale.

#### Termometro

Indica la temperatura del liquido di raffreddamento tramite l'accensione di un numero variabile di segmenti su una scala di misura graduata. Quando la temperatura si trova al di fuori del campo di funzionamento normale, possono apparire le seguenti indicazioni:

- sul display compare un unico segmento lampeggiante; è il segnale di temperatura bassa;
- tutti i segmenti sono accesi mentre il segmento superiore lampeggia; è il segnale di temperatura alta.



**Pericolo - Attenzione:** in caso di temperatura alta, arrestare la motocicletta e controllare il livello del liquido di raffreddamento. Nel caso in cui fosse necessario rabboccarlo, rivolgersi presso un centro assistenza autorizzato MV Agusta (vedi § 3.8). Se l'indicazione compare nonostante il livello sia corretto, non proseguire la marcia e contattare un centro assistenza autorizzato MV Agusta.



### 3.8. Tabella lubrificanti e liquidi

Descrizione	Prodotto consigliato	Specifiche
Olio lubrificazione motore	Motul 7100 4T 5W40 (*)	SAE 5W40
Liquido di raffreddamento	Motul Motocool Factory Line	Prodotto a base di glicole monoetilenico Pronto all'uso - Non diluire
Fluido comando frizione e freni	Motul DOT 3 & 4 Brake Fluid	DOT4
Olio lubrificazione catena	Motul Chain Lube Road	–

\* : Per la reperibilità del prodotto consigliato, MV Agusta consiglia di rivolgersi direttamente ai propri concessionari autorizzati. Il motore del motociclo Brutale è stato sviluppato con olio motore Motul 7100 4T 5W40. Qualora il lubrificante descritto non fosse reperibile, MV Agusta consiglia l'utilizzo di olii completamente sintetici con caratteristiche conformi o superiori alle seguenti normative:

- Conforme API SN / SM
- Conforme JASO MA2
- Gradazione SAE 5W40

#### NOTA

Le specifiche sopra indicate devono essere riportate, da sole od insieme ad altre, sul contenitore dell'olio lubrificante.





#### 4.1. Uso della motocicletta

In questa sezione vengono esposti gli argomenti principali per il corretto uso della motocicletta.



##### **ATTENZIONE**

Il motociclo Brutale presenta elevate caratteristiche di potenza e prestazioni; per il suo uso è pertanto richiesto un'adeguato livello di conoscenza del mezzo. Al momento del primo utilizzo di questo veicolo è necessario adottare un atteggiamento prudente. Uno stile di guida aggressivo o avventato può esporre al rischio di incidenti, compromettendo la Vostra incolumità e quella di altre persone.



##### **ATTENZIONE**

LE LIMITAZIONI RELATIVE ALL'USO CONSENTITO DEL VEICOLO SONO RIPORTATE NELLA SEZIONE "INFORMAZIONI PER LA SICUREZZA".





## 4.2. Rodaggio



**Cautela - Precauzione:** l'inosservanza delle indicazioni di seguito riportate può pregiudicare la durata e le prestazioni della motocicletta.

È uso comune considerare il rodaggio come una fase applicata al solo motore. In realtà esso va considerato anche per altre parti importanti della moto, in particolare i pneumatici, i freni, la catena di trasmissione, ecc. Nei primissimi chilometri adottare una guida tranquilla.

4

### Da 0 a 500 Km (da 0 a 300 mi) (A)

Durante questa percorrenza variare frequentemente il regime di rotazione del motore. Se possibile, privilegiare percorsi leggermente collinosi, con molte curve ed evitare lunghi tratti rettilinei.



### ATTENZIONE

I pneumatici nuovi devono essere sottoposti ad un adeguato rodaggio per raggiungere la completa efficienza. Evitare le accelerazioni, le curve e le frenate brusche per i primi 100 km. Se non si osserva un periodo di rodaggio iniziale dei pneumatici, si rischia di slittare o di perdere il controllo del veicolo con conseguente pericolo di incidenti.



❑ **Da 500 a 1000 Km (da 300 a 600 mi)**

Durante questa percorrenza evitare di mantenere a lungo il motore sotto sforzo.



❑ **Da 1000 a 2500 Km (da 600 a 1600 mi)**

Durante questa percorrenza è possibile pretendere maggiori prestazioni dal motore, senza tuttavia superare il regime di rotazione indicato.





### 4.3. Avviamento motore



**ATTENZIONE:** Far funzionare il motore in un ambiente chiuso può essere pericoloso. I gas di scarico contengono monossido di carbonio, un gas incolore ed inodore che può provocare decessi o infortuni gravi. Fare funzionare il motore solo all'esterno, all'aria aperta.

▶ Ruotando l'interruttore d'accensione in posizione "ON", la strumentazione e le spie eseguono l'autodiagnosi; durante questa fase, accertarsi dell'accensione di tutte le spie presenti sul cruscotto.

▶ Affinché il sistema di interruzione del circuito di accensione dia il consenso all'avviamento, deve essere stata soddisfatta una delle seguenti condizioni:

- Il cambio è in posizione di folle con la leva della frizione tirata.
- Il cambio è innestato su una marcia con la leva della frizione tirata ed il cavalletto laterale alzato.

**NOTA:** Quando mancano meno di 1000 km all'esecuzione del prossimo intervento di manutenzione programmata, sul display compare la schermata di avviso raffigurata a lato.





► Nel caso in cui l'autodiagnosi riscontri la presenza di un guasto al veicolo, sul display compare la schermata di errore mostrata nella figura a lato. In particolare viene evidenziato il gruppo o il componente della motocicletta su cui è stato riscontrato il malfunzionamento.



► Premendo il pulsante "OK", il cruscotto passa alla modalità "RUN".

**ATTENZIONE**

In caso di segnalazione di un guasto al veicolo, non avviare il motore e contattare un centro assistenza autorizzato MV Agusta.





#### ❑ Procedura di avviamento

- ▶ Premere il pulsante di avviamento motore senza ruotare la manopola dell'acceleratore.
- ▶ Appena il motore si è avviato rilasciare il pulsante.



#### Cautela - Precauzione:

- Per evitare danni all'impianto elettrico non azionare l'avviamento per più di 5 secondi consecutivi.
  - Non far funzionare a lungo il motore a motocicletta ferma. Il conseguente surriscaldamento può danneggiare i componenti interni del motore.
- È preferibile portare il motore alla temperatura di esercizio ponendosi in marcia ad andatura ridotta.
- Per allungare al massimo la vita del motore, non accelerare a fondo quando il motore è freddo.

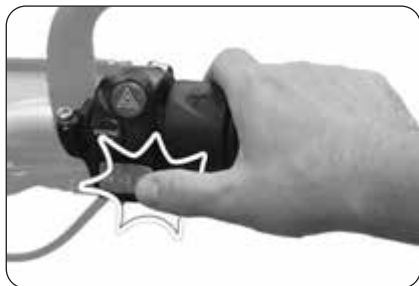



#### 4.4. Selezione e modifica delle funzioni display

La strumentazione prevede la possibilità di intervenire su alcuni dei parametri principali di misurazione.

Le operazioni possibili sono :

- Selezione delle modalità di funzionamento:
  - “RUN” (Contachilometri)
  - “SPEED LIMITER” (Limitatore velocità)
  - “TC” (Controllo trazione)
  - “CHRONO” (Cronometro)
  - “ABS” (Sistema antibloccaggio)
  - “QUICK SHIFT” (Cambio rapido)
  - “CLOCK” (Orologio)
- Azzeramento delle funzioni contachilometri parziali:

Contachilometri	Parziale 1	“TRIP 1”
Contachilometri	Parziale 2	“TRIP 2”
- Attivazione della funzione cronometro
- Impostazione dell'orologio
- Funzione “IMMOBILIZER” (Sistema antifurto)
- Selezione mappatura centralina





#### 4.4.1. Selezione funzioni display

La selezione riguarda le seguenti modalità di funzionamento:

- “RUN” (Contachilometri)
- “SPEED LIMITER” (Limitatore velocità)
- “TC” (Controllo trazione)
- “CHRONO” (Cronometro)
- “ABS” (Sistema antibloccaggio)
- “QUICK SHIFT” (Cambio rapido)
- “CLOCK” (Orologio)

La visualizzazione delle varie modalità di funzionamento avviene premendo il pulsante “SET” per un tempo inferiore a tre secondi. Agendo su tale pulsante appaiono sul display le funzioni in modo ciclico. Selezionare la funzione desiderata.



#### ATTENZIONE

Le operazioni di modifica o regolazione delle funzioni display devono essere eseguite con motore spento, cambio in folle, motocicletta ferma e piedi a terra. È vietato cambiare le impostazioni del display durante la marcia eccetto dove altrimenti indicato.



#### ❑ Modalità “RUN”

Oltre alla funzione tachimetro, sul display vengono visualizzate le seguenti funzioni (vedi §4.4.2.):

- Contachilometri Totale “TOTAL”
- Contachilometri Parziale 1 “TRIP 1”

In alternativa:

- Contachilometri Totale “TOTAL”
- Contachilometri Parziale 2 “TRIP 2”

#### ❑ Modalità “SPEED LIMITER”

Questa modalità permette di selezionare il valore della velocità massima della motocicletta secondo le proprie esigenze di guida (vedi §4.4.3.).







#### ❑ Modalità “TC”

La presente funzione permette di adattare il livello del controllo di trazione del motore secondo le proprie esigenze di guida (vedi §4.4.4.).



#### ❑ Modalità “CHRONO”

Questa modalità permette l'attivazione della funzione cronometro e l'immagazzinamento dei dati misurati (vedi §4.4.5.). Le funzioni visualizzate diventano:

- Cronometro Giro attuale “CURRENT LAP”
- Cronometro Giro più veloce “BEST LAP”
- Cronometro Giro precedente “LAST LAP”
- Contagiri Totale giri percorsi “N° LAP”





#### ❑ Modalità “ABS”

La presente funzione permette di attivare o disattivare il sistema antibloccaggio ABS del sistema frenante (vedi §4.4.6.).



#### ❑ Modalità “QUICK SHIFT”

Questa modalità permette di attivare o disattivare la funzione di cambio rapido del rapporto di trasmissione (vedi §4.4.7.).





#### ☐ Modalità “CLOCK”

La presente funzione consente di modificare l'orario (ore e minuti) riportato sul cruscotto (vedi §4.4.8.).





#### 4.4.2. Azzeramento delle funzioni contachilometri parziali

I valori delle funzioni “TRIP 1” e “TRIP 2” possono essere azzerati nel modo seguente.



##### ATTENZIONE

Le operazioni di modifica o regolazione delle funzioni display devono essere eseguite con motore spento, cambio in folle, motocicletta ferma e piedi a terra. È vietato cambiare le impostazioni del display durante la marcia.

- ▶ Accedere alla modalità “RUN”; nella schermata iniziale vengono visualizzate le funzioni contachilometri totale (“TOTAL”) e contachilometri parziale 1 (“TRIP 1”).
- ▶ Premendo ora il pulsante “OK” per un tempo superiore a tre secondi il valore “TRIP 1” si azzer.





► Premere il pulsante “OK” per un tempo inferiore a tre secondi fino alla visualizzazione della funzione contachilometri parziale 2 (“TRIP 2”).



► Premendo ora il pulsante “OK” per un tempo superiore a tre secondi il valore “TRIP 2” si azzerà.





#### 4.4.3. Modalità “SPEED LIMITER”

Al momento dell'accensione del motore la funzione “SPEED LIMITER” è disattivata. Per attivarla occorre eseguire le seguenti operazioni:

- Premere il pulsante “SET” per accedere alla modalità “SPEED LIMITER”. Il valore mostrato della velocità massima (corrispondente alla velocità attuale del veicolo) inizia a lampeggiare.

**NOTA: Le operazioni di modifica o regolazione della velocità massima possono essere eseguite con il veicolo in movimento.**

- Premendo il pulsante “SET” per un tempo inferiore a tre secondi, il livello della velocità massima viene diminuito di **2 km/h** rispetto a quello attualmente mostrato sul display. Viceversa, premendo il pulsante “OK” per un tempo inferiore a tre secondi, il livello della velocità massima viene incrementato di **2 km/h** rispetto a quello attualmente mostrato sul display.





► Premendo il pulsante “OK” per un tempo superiore a tre secondi, il valore prescelto della velocità massima viene confermato. La cifra indicata smette di lampeggiare e il cruscotto ritorna alla modalità “RUN”.

► Se invece si preme il pulsante “SET” per un tempo superiore a tre secondi, la funzione “SPEED LIMITER” viene disattivata. Sul display viene visualizzata la scritta “OFF”. Dopo tre secondi, il cruscotto ritorna alla modalità “RUN”.



► Nel caso in cui la funzione “SPEED LIMITER” sia stata attivata, durante la marcia del veicolo l’indicazione della velocità sul tachimetro inizia a lampeggiare quando raggiunge il valore impostato della velocità massima.



#### 4.4.4. Modalità “TC”

► Premere il pulsante “SET” per accedere alla modalità “TC”, quindi premere il pulsante “OK” per un tempo inferiore ai tre secondi fino alla visualizzazione della scritta “TC LEVEL”. L’attuale livello del controllo di trazione corrisponde al valore visualizzato sul display.

 **NOTA: Le operazioni di modifica o regolazione del livello del controllo di trazione possono essere eseguite con il veicolo in movimento.**

► Premendo il pulsante “OK” per un tempo inferiore a tre secondi, il livello del controllo di trazione viene incrementato passando al valore successivo. Viceversa, premendo il pulsante “SET” per un tempo inferiore a tre secondi, il livello del controllo di trazione viene diminuito passando al valore immediatamente inferiore. Tale valore può variare tra **0** e **8**.

► Premere il pulsante “SET” per un tempo superiore a tre secondi; il valore prescelto del livello del controllo di trazione viene confermato.



4





#### 4.4.5. Cronometro

##### □ Acquisizione dei tempi sul giro

► Dopo aver attivato la funzione cronometro (modalità "CHRONO") è possibile iniziare l'acquisizione dei dati relativi ai tempi di percorrenza sul giro.



► L'azionamento del pulsante del lampeggio faro abbagliante determina l'inizio della misurazione dei dati. I puntini che separano i minuti dai secondi e dai decimi di secondo iniziano a lampeggiare. Lo strumento sta acquisendo i tempi.

**NOTA:** Quando la modalità "CHRONO" è attiva, il primo azionamento del pulsante di lampeggio faro abilita automaticamente la funzione "TC". Da questo momento è possibile modificare il livello del controllo di trazione con effetto immediato utilizzando opportunamente i tasti "SET" e "OK" (vedi §4.4.4.).





► Premendo nuovamente il pulsante del lampeggio fanale abbagliante viene registrata la misurazione del tempo relativo al 1° giro percorso. Contemporaneamente lo strumento inizia ad acquisire il tempo relativo al secondo giro.

La misurazione del tempo relativo al primo giro viene conservata in memoria e rimane visualizzata sul display per dieci secondi, quindi si procede con la visualizzazione del tempo sul giro successivo.

► Continuando nell'utilizzo del cronometro, ad ogni azionamento del pulsante di lampeggio viene registrato un tempo. Lo strumento ha la possibilità di eseguire un numero massimo di 100 memorizzazioni consecutive.

Durante la visualizzazione del tempo sul giro appena concluso, sul display compare il simbolo "+" oppure "-" nel caso in cui il tempo rilevato sia rispettivamente inferiore o superiore al tempo misurato durante il giro precedente.





#### ❑ Visualizzazione dei dati

Terminata la fase di acquisizione tempi è possibile eseguirne la visualizzazione.

► Accedere alla modalità “CHRONO”; in questa schermata viene visualizzato il tempo sul giro più veloce (“BEST LAP”) ed il tempo sull’ultimo giro percorso (“LAST LAP”).

4



#### ATTENZIONE

Le operazioni di modifica o regolazione delle funzioni display devono essere eseguite con motore spento, cambio in folle, motocicletta ferma e piedi a terra. È vietato cambiare le impostazioni del display durante la marcia.

► Premere il pulsante “OK” per un tempo inferiore ai tre secondi fino alla visualizzazione della scritta “LAPS VIEW”.





► La ripetuta pressione del pulsante del lampeggio fanale abbagliante consente di visualizzare in sequenza tutti i tempi precedentemente acquisiti a partire dall'ultimo giro memorizzato.

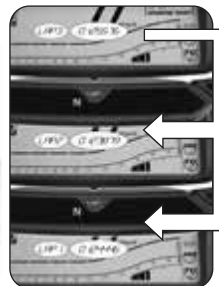

► Al termine della visualizzazione dei dati, la pressione del pulsante "SET" consente di tornare alla modalità "LAPS VIEW" per passare alla modalità successiva.



4



## ❑ Cancellazione dei dati

L'operazione di cancellazione dei dati memorizzati si esegue applicando le seguenti procedure:



### ATTENZIONE

Le operazioni di modifica o regolazione delle funzioni display devono essere eseguite con motore spento, cambio in folle, motocicletta ferma e piedi a terra. È vietato cambiare le impostazioni del display durante la marcia.

▶ *Cancellazione tempi singoli:* Accedere alla modalità "CHRONO" e premere il pulsante "SET" per un tempo inferiore ai tre secondi fino alla visualizzazione della scritta "SINGLE LAP RESET".

▶ Premere il pulsante "OK" per un tempo inferiore a tre secondi; il valore dell'ultimo tempo sul giro memorizzato inizia a lampeggiare.





► Premendo ora il pulsante “OK” per un tempo superiore a tre secondi il valore viene cancellato.  
Se invece si preme il pulsante “SET” per un tempo inferiore ai tre secondi la procedura di cancellazione viene interrotta.

► Successivamente, la pressione del pulsante del lampeggio fanale abbagliante seguita dalla pressione del pulsante “OK” per un tempo superiore a tre secondi consente di cancellare in sequenza tutti i tempi precedentemente acquisiti.

► Al termine della cancellazione dei dati, la pressione del pulsante “SET” consente di tornare alla modalità “SINGLE LAP RESET” per passare alla modalità successiva.



4



► *Cancellazione miglior tempo*: Accedere alla modalità "CHRONO" e premere il pulsante "SET" per un tempo inferiore ai tre secondi fino alla visualizzazione della scritta "BEST LAP RESET".



► Premere il pulsante "OK" per un tempo inferiore a tre secondi; il valore del tempo sul giro più veloce inizia a lampeggiare.





► Premendo ora il pulsante “OK” per un tempo superiore a tre secondi il valore viene cancellato.

Se invece si preme il pulsante “SET” per un tempo inferiore ai tre secondi la procedura di cancellazione viene interrotta.

► Al termine della cancellazione dei dati, la pressione del pulsante “SET” consente di uscire dalla modalità “BEST LAP RESET” per passare alla modalità successiva.

► *Cancellazione di tutti i tempi memorizzati:* Accedere alla modalità “CHRONO” e premere il pulsante “SET” per un tempo inferiore ai tre secondi fino alla visualizzazione della scritta “ALL LAPS RESET”.

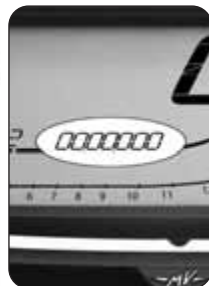





► Premere il pulsante “OK” per un tempo inferiore a tre secondi; il display richiede la conferma per la cancellazione di tutti i dati presenti in memoria.



► Premendo ora il pulsante “OK” per un tempo superiore a tre secondi tutti i tempi precedentemente acquisiti vengono cancellati.

Se invece si preme il pulsante “SET” per un tempo inferiore ai tre secondi la procedura di cancellazione viene interrotta.

► Al termine della cancellazione dei dati, la pressione del pulsante “SET” consente di uscire dalla modalità “ALL LAPS RESET” per tornare alla modalità “CHRONO”.





#### 4.4.6. Selezione della funzione ABS

► Premere il pulsante “SET” per accedere alla modalità “ABS”; sul display viene visualizzata la scritta “SETTING ABS”.



#### ATTENZIONE

Le operazioni di modifica o regolazione delle funzioni display devono essere eseguite con motore spento, cambio in folle, motocicletta ferma e piedi a terra. È vietato cambiare le impostazioni del display durante la marcia.

► Premendo il pulsante “OK” per un tempo inferiore a tre secondi, sul display viene visualizzata la scritta lampeggiante “ABS ON”.

► Se non si preme alcun pulsante, dopo tre secondi la selezione “ABS ON” viene confermata; in questa condizione il sistema ABS è attivato. Premere il pulsante “SET” per uscire dalla modalità “ABS”.





- ▶ Se invece si preme il pulsante “OK” mentre l’indicazione lampeggia, la scritta sul display passa a “ABS OFF”.
- ▶ Se non si preme alcun pulsante, dopo tre secondi la selezione “ABS OFF” viene confermata; in questa condizione il sistema ABS è disattivato. Premere il pulsante “SET” per uscire dalla modalità “ABS”.

**ATTENZIONE**

La disattivazione del sistema ABS viene indicata dall'accensione della relativa spia sul cruscotto (vedi §3.7.1). In questa condizione la funzione antibloccaggio del sistema frenante non è disponibile. Adottare particolare cautela nella guida e ridurre la velocità per mantenere il controllo del veicolo durante le frenate di emergenza.



#### 4.4.7. Modalità “QUICK SHIFT”

► Premere il pulsante “SET” per accedere alla modalità “QUICK SHIFT”. Il display mostra lo stato di attivazione della funzione cambio rapido (“ON”: attivata; “OFF”: disattivata).



#### ATTENZIONE

Le operazioni di modifica o regolazione delle funzioni display devono essere eseguite con motore spento, cambio in folle, motocicletta ferma e piedi a terra. È vietato cambiare le impostazioni del display durante la marcia.

► Premendo il pulsante “OK” per un tempo inferiore a tre secondi, l’indicazione relativa allo stato di attivazione della funzione cambio rapido inizia a lampeggiare.

► Premendo il pulsante “OK” per un tempo inferiore a tre secondi, l’indicazione passa da “OFF” a “ON” o viceversa.

► Premendo il pulsante “SET”, lo stato di attivazione selezionato del cambio rapido viene confermato.





#### 4.4.8. Impostazione dell'orologio

► Per eseguire l'impostazione dell'orario, premere il pulsante "SET" fino alla visualizzazione della scritta "CLOCK SETTING".



#### ATTENZIONE

Le operazioni di modifica o regolazione delle funzioni display devono essere eseguite con motore spento, cambio in folle, motocicletta ferma e piedi a terra. È vietato cambiare le impostazioni del display durante la marcia.

► Premere il pulsante "OK" per un tempo inferiore a tre secondi; la cifra dell'ora inizia a lampeggiare.

► Premendo nuovamente il pulsante "OK" per un tempo inferiore a tre secondi, la cifra dell'ora viene incrementata passando al valore successivo.

► Premere il pulsante "OK" per un tempo superiore a tre secondi; la cifra prescelta dell'ora viene confermata. Se invece si preme il pulsante "SET" per un tempo inferiore ai tre secondi la procedura di impostazione viene interrotta.

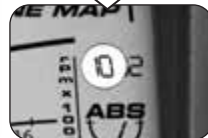
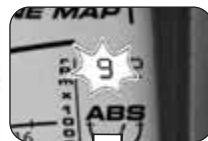



- ▶ Dopo avere eseguito l'impostazione della cifra dell'ora, il cruscotto passa automaticamente all'impostazione della cifra dei minuti. La cifra dei minuti inizia a lampeggiare.
- ▶ Premendo il pulsante "OK" per un tempo inferiore a tre secondi, la cifra dei minuti viene incrementata passando al valore successivo.
- ▶ Premere il pulsante "OK" per un tempo superiore a tre secondi; la cifra prescelta dei minuti viene confermata ed il cruscotto ritorna alla modalità "CLOCK". Se invece si preme il pulsante "SET" per un tempo inferiore ai tre secondi la procedura di impostazione viene interrotta.





#### 4.4.9. Funzione “Immobilizer”

La funzione “IMMOBILIZER” consente l’avviamento del motore solamente a seguito del riconoscimento della chiave di avviamento originale. Di fatto essa rappresenta un sistema antifurto integrato nel circuito elettronico del veicolo, dal momento che ne impedisce l’utilizzo a qualunque soggetto non autorizzato.

La modalità “IMMOBILIZER” del cruscotto deve essere utilizzata solamente in caso di malfunzionamento. Infatti, se per un motivo qualsiasi il sistema non risulta in grado di riconoscere il codice della chiave di avviamento, per ottenere il consenso all’avviamento del motore è necessario inserire manualmente il codice segreto riportato sulla MV Code Card ricevuta al momento della consegna del veicolo.

- ▶ Rimuovere la copertura dal riquadro presente sul retro della MV Code Card e leggere il codice elettronico segreto relativo alla chiave di avviamento (nella figura è rappresentato un codice casuale a puro titolo indicativo).
- ▶ Partendo dalla modalità “RUN”, premere il pulsante “SET” per un tempo superiore a dieci secondi per accedere alla modalità “IMMOBILIZER”.



**ATTENZIONE**

Le operazioni di modifica o regolazione delle funzioni display devono essere eseguite con motore spento, cambio in folle, motocicletta ferma e piedi a terra. È vietato cambiare le impostazioni del display durante la marcia.

- ▶ Premere il pulsante “OK” per un tempo inferiore a tre secondi per impostare la prima cifra del codice.
- ▶ La pressione del pulsante “OK” per un tempo inferiore a tre secondi consente di variare tra 0 e 9 il valore relativo alla prima cifra.
- ▶ Una volta selezionata la cifra prescelta, premere il pulsante “OK” per un tempo superiore a tre secondi; la prima cifra del codice viene confermata. È ora possibile impostare la seconda cifra del codice.
- ▶ Operando in maniera analoga, è possibile procedere con l'impostazione delle tre cifre rimanenti.



4





► Una volta completata la procedura di inserimento del codice, sul display compare la scritta “CONFIRM CODE”. Premere il pulsante “OK” per un tempo superiore a tre secondi per confermare il codice inserito.



► Se il codice inserito viene correttamente riconosciuto dal sistema, compare la scritta “VALID CODE”. Il display del cruscotto ritorna alla modalità “RUN”. È possibile avviare il motore.

► Se il codice inserito è errato, compare la scritta “NOT VALID CODE”. Il sistema non dà il consenso all'avviamento del motore; il display ritorna alla modalità “IMMOBILIZER”. Ripetere dall'inizio la procedura di inserimento del codice, facendo attenzione a impostare tutte le cifre corrette riportate sulla MV Code Card in dotazione. Nel caso si riscontrassero ulteriori problemi, contattare un centro assistenza autorizzato MV Agusta.





#### 4.4.10. Selezione della mappatura centralina

Sul modello Brutale, è possibile selezionare differenti mappature della centralina che permettono di ottenere caratteristiche variabili di potenza e prestazioni a seconda del tipo di utilizzo del veicolo.

##### NOTA

**Le operazioni di selezione della mappatura centralina possono essere eseguite con il veicolo in movimento.**

La selezione della mappatura centralina può essere effettuata premendo il relativo pulsante sul lato destro del manubrio. In questo modo la mappatura passa al valore successivo. Le relative caratteristiche della mappatura sono elencate nella seguente tabella.

Mappatura	N	R	S	C
Modalità	Normale	Pioggia	Sportiva	Personalizzata



4



#### ❑ Impostazione della mappatura personalizzata

► Premere il pulsante “ENGINE MAP” fino a selezionare la mappatura “C” della centralina (mappatura personalizzata).



**ATTENZIONE:** Le operazioni di impostazione della mappatura personalizzata devono essere eseguite con cambio in folle, motocicletta ferma e piedi a terra. È vietato cambiare le impostazioni del display durante la marcia.

► Premere il pulsante “SET” fino alla visualizzazione della scritta “SETTING CUSTOM MAP”.

Per modificare l'impostazione dei parametri della mappatura secondo le proprie esigenze, operare come di seguito descritto.

**NOTA:** La mappatura personalizzata può essere creata selezionando alternativamente le caratteristiche delle mappe Normal, Rain e Sport sui parametri di seguito elencati.

► *Sensibilità del comando acceleratore:* Premere il pulsante “OK” per un tempo inferiore ai tre secondi fino alla visualizzazione della scritta “GAS SENSITIVITY”.





► Premere il pulsante “SET” per un tempo inferiore ai tre secondi. Sul display compare l’attuale impostazione selezionata per la sensibilità del comando acceleratore.



► Premere il pulsante “OK” per un tempo inferiore ai tre secondi; l’indicazione sul display inizia a lampeggiare.

► La ripetuta pressione del pulsante “OK” per un tempo inferiore ai tre secondi permette di visualizzare in sequenza le seguenti impostazioni:

- “NORMAL” (Normale)
- “RAIN” (Pioggia)
- “SPORT” (Sportiva)

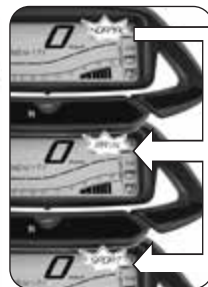



► Premere il pulsante “OK” per un tempo superiore ai tre secondi; la nuova impostazione selezionata viene confermata. L’indicazione sul display smette di lampeggiare e dopo alcuni secondi ritorna al menu “GAS SENSITIVITY”. É ora possibile passare alla regolazione del parametro successivo.



► *Coppia massima del motore:* Premere il pulsante “OK” per un tempo inferiore ai tre secondi fino alla visualizzazione della scritta “MAX ENGINE TORQUE”.





► Premere il pulsante “SET” per un tempo inferiore ai tre secondi. Sul display compare l’attuale impostazione selezionata per la coppia massima del motore.

► Premere il pulsante “OK” per un tempo inferiore ai tre secondi; l’indicazione sul display inizia a lampeggiare.

► La ripetuta pressione del pulsante “OK” per un tempo inferiore ai tre secondi permette di visualizzare in sequenza le seguenti impostazioni:

- “RAIN” (Pioggia)
- “SPORT” (Sportiva)





► Premere il pulsante “OK” per un tempo superiore ai tre secondi; la nuova impostazione selezionata viene confermata. L’indicazione sul display smette di lampeggiare e dopo alcuni secondi ritorna al menu “MAX ENGINE TORQUE”.



► *Freno motore:* Premere il pulsante “OK” per un tempo inferiore ai tre secondi fino alla visualizzazione della scritta “ENGINE BRAKE”.





► Premere il pulsante “SET” per un tempo inferiore ai tre secondi. Sul display compare l’attuale impostazione selezionata per il freno motore.



► Premere il pulsante “OK” per un tempo inferiore ai tre secondi; l’indicazione sul display inizia a lampeggiare.

► La ripetuta pressione del pulsante “OK” per un tempo inferiore ai tre secondi permette di visualizzare in sequenza le seguenti impostazioni:

- “NORMAL” (Normale)
- “SPORT” (Sportiva)







► Premere il pulsante “OK” per un tempo superiore ai tre secondi; la nuova impostazione selezionata viene confermata. L’indicazione sul display smette di lampeggiare e dopo alcuni secondi ritorna al menu “ENGINE BRAKE”.



► *Erogazione del motore:* Premere il pulsante “OK” per un tempo inferiore ai tre secondi fino alla visualizzazione della scritta “ENGINE RESPONSE”.





► Premere il pulsante “SET” per un tempo inferiore ai tre secondi. Sul display compare l’attuale impostazione selezionata per l’erogazione del motore.

► Premere il pulsante “OK” per un tempo inferiore ai tre secondi; l’indicazione sul display inizia a lampeggiare.

► La ripetuta pressione del pulsante “OK” per un tempo inferiore ai tre secondi permette di visualizzare in sequenza le seguenti impostazioni:

- “SLOW” (Erogazione lenta)
- “FAST” (Erogazione rapida)





► Premere il pulsante “OK” per un tempo superiore ai tre secondi; la nuova impostazione selezionata viene confermata. L’indicazione sul display smette di lampeggiare e dopo alcuni secondi ritorna al menu “ENGINE RESPONSE”.



► *Limitatore giri motore:* Premere il pulsante “OK” per un tempo inferiore ai tre secondi fino alla visualizzazione della scritta “RPM LIMITER”.





► Premere il pulsante “SET” per un tempo inferiore ai tre secondi. Sul display compare l’attuale impostazione selezionata per il limitatore giri motore.

► Premere il pulsante “OK” per un tempo inferiore ai tre secondi; l’indicazione sul display inizia a lampeggiare.

► La ripetuta pressione del pulsante “OK” per un tempo inferiore ai tre secondi permette di visualizzare in sequenza le seguenti impostazioni:

- “NORMAL” (Normale)
- “SPORT” (Sportiva)





► Premere il pulsante “OK” per un tempo superiore ai tre secondi; la nuova impostazione selezionata viene confermata. L’indicazione sul display smette di lampeggiare e dopo alcuni secondi ritorna al menu “RPM LIMITER”.



► Premere il pulsante “OK” per un tempo inferiore ai tre secondi fino alla visualizzazione del display in modalità “RUN”. La procedura di impostazione della mappatura personalizzata è così completata.





#### 4.4.11. Messaggi di errore / malfunzionamento

Il cruscotto può segnalare la presenza di un guasto o di un malfunzionamento durante le diverse condizioni di utilizzo della motocicletta.

► *Avviamento motore:* Ruotando l'interruttore d'accensione in posizione "ON", la strumentazione e le spie eseguono l'autodiagnosi. In presenza di un guasto al veicolo, il display visualizza il messaggio di errore mostrato nella figura a lato; in particolare, viene evidenziato il gruppo o il componente della motocicletta su cui è stato riscontrato il malfunzionamento.

► Premendo il pulsante "OK", il cruscotto passa alla modalità "RUN".



#### ATTENZIONE

**Nel caso in cui l'autodiagnosi evidenzi la presenza di un guasto a veicolo fermo, non avviare il motore e contattare un centro assistenza autorizzato MV Agusta.**





► *Marcia del veicolo:* Quando viene rilevato un guasto sul veicolo durante la marcia, nella parte inferiore del display viene visualizzato il messaggio di errore mostrato a lato.

**ATTENZIONE**

**Nel caso in cui venga segnalata la presenza di un guasto durante l'utilizzo del veicolo, non proseguire la marcia e contattare un centro assistenza autorizzato MV Agusta.**



► Al momento dell'arresto del veicolo, sul display viene visualizzato il messaggio di errore che evidenzia il gruppo o il componente della motocicletta su cui è stato riscontrato il malfunzionamento.



► *Alta temperatura del liquido di raffreddamento*: Se il sistema rileva un valore eccessivamente elevato della temperatura del liquido di raffreddamento, sul display viene visualizzato il messaggio di errore mostrato a lato. La schermata in questione può comparire durante qualsiasi condizione di utilizzo del veicolo.



**ATTENZIONE:** In caso di temperatura alta, arrestare la motocicletta e controllare il livello del liquido di raffreddamento. Nel caso in cui fosse necessario rabboccarlo, rivolgersi presso un centro assistenza autorizzato MV Agusta (vedi § 3.8). Se l'indicazione compare nonostante il livello sia corretto, non proseguire la marcia e contattare un centro assistenza autorizzato MV Agusta.







#### 4.5. Rifornimento carburante



**Pericolo - Attenzione:** la benzina e i suoi vapori sono estremamente infiammabili e nocivi. Evitare il contatto e l'inalazione.

Durante il rifornimento spegnere il motore, non fumare, tenere lontane fiamme, scintille e fonti di calore. Effettuate il rifornimento all'aperto o in locale ben ventilato.



**Cautela - Precauzione:** Utilizzare esclusivamente carburante avente le seguenti caratteristiche:

- Benzina senza piombo
- Contenuto di etanolo fino al 10% di volume
- Numero di ottano ricerca (R.O.N.) di 95 o superiore



Tale necessità è ricordata da un punto verde sul lato inferiore del tappo serbatoio e dalla targhetta "E10" presente sul serbatoio.



- ▶ Sollevare il coperchio parapolvere.
- ▶ Inserire la chiave e ruotarla in senso orario.





► Sollevare il tappo ed eseguire il rifornimento di carburante.



**ATTENZIONE:** Un riempimento eccessivo del serbatoio può far traboccare il carburante a causa dell'espansione dovuta al calore del motore o all'esposizione della motocicletta alla luce solare. Eventuali fuoriuscite di carburante possono provocare incendi. Il livello del carburante nel serbatoio non deve mai superare la base del bocchettone di riempimento.

► Dopo il rifornimento premere il tappo verso il basso ruotando contemporaneamente la chiave in senso orario per facilitare la chiusura. Quindi rilasciare la chiave ed estrarla.



**Cautela-Precauzione:** Asciugare subito con un panno pulito l'eventuale carburante versato, in quanto può deteriorare le superfici verniciate o di plastica.



**ATTENZIONE:** Verificare che il tappo del serbatoio del carburante sia chiuso correttamente prima di utilizzare il motociclo.

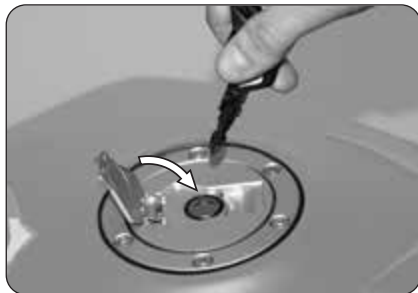



#### 4.6. Rimozione sella passeggero

- ▶ Inserire la chiave nella serratura.
- ▶ Ruotare la chiave in senso antiorario e contemporaneamente premere leggermente sulla sella. Sollevare la sella e rimuoverla come mostrato in figura.

Per il rimontaggio del particolare osservare le seguenti indicazioni :

- Ruotare la chiave nella serratura;
- Riposizionare e agganciare la sella;
- Premere sulla sella;
- Rilasciare la chiave;
- Premere nuovamente la sella assicurandosi di averla saldamente agganciata alla struttura.



#### ATTENZIONE

Dopo aver rimosso e rimontato la sella, e comunque prima di ogni utilizzo della moto, assicurarsi che il componente sia stato posizionato correttamente e che risulti ben ancorato alla struttura portante del veicolo.

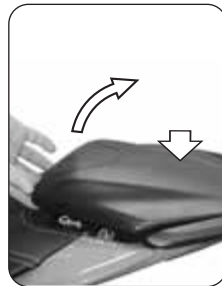
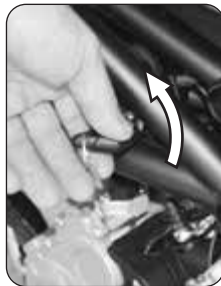



#### 4.7. Rimozione sella pilota

- ▶ Rimuovere la sella passeggero come indicato nel paragrafo §4.6.
- ▶ Rimuovere le due viti posteriori di fissaggio e i relativi distanziali tramite un cacciavite a testa esagonale da 4 mm. Sollevare la sella e rimuoverla come mostrato in figura.

Per il rimontaggio del particolare osservare le seguenti indicazioni :

- Riposizionare la sella;
- Rimontare le due viti posteriori di fissaggio della sella con i relativi distanziali;
- Rimontare la sella passeggero come indicato nel paragrafo §4.6.



#### ATTENZIONE

Dopo aver rimosso e rimontato la sella, e comunque prima di ogni utilizzo della moto, assicurarsi che il componente sia stato posizionato correttamente e che risulti ben ancorato alla struttura portante del veicolo.





#### 4.8. Sosta della motocicletta

##### □ Sosta con cavalletto laterale



##### **ATTENZIONE**

Parcheggiare la motocicletta in condizioni di sicurezza e su terreno stabile. Per la sosta in pendenza parcheggiare con la ruota anteriore a monte e con la prima marcia inserita; ricordarsi di riportare il cambio in folle prima di riavviare la moto. Non lasciare il veicolo incustodito con la chiave di accensione inserita nel quadro.



##### **ATTENZIONE**

Quando il veicolo è in sosta sul cavalletto laterale, è pericoloso sedere a bordo gravando perciò col proprio peso sull'unico appoggio di stazionamento. Prima di mettersi in marcia verificare il funzionamento dell'interruttore di sicurezza accertandosi che la spia di apertura cavalletto laterale sul cruscotto si spenga; in ogni caso verificare che il cavalletto sia rientrato. Se si nota una disfunzione, fare controllare l'impianto da un concessionario MV Agusta prima di utilizzare il mezzo.

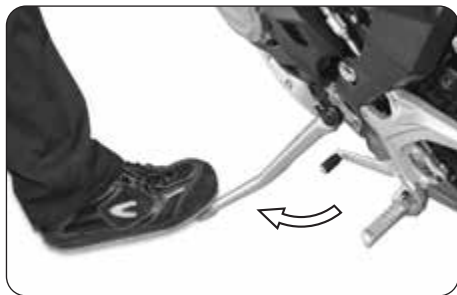

► Abbassare il cavalletto col piede fino alla battuta ed inclinare lentamente la motocicletta per porre il piedino di appoggio in contatto col suolo.



### □ Sosta con cavalletto posteriore

Inserire il perno del cavalletto nel foro dell'asse ruota posteriore dal lato sinistro della motocicletta; appoggiare il cavalletto al suolo e facendo forza su di esso sollevare il veicolo fino al raggiungimento della condizione di stabilità.



#### ATTENZIONE

Questa operazione deve essere eseguita da due persone.





### 5.1. Elenco regolazioni

La motocicletta possiede un'ampia possibilità di regolazioni che possono migliorare l'ergonomia, l'assetto e la sicurezza.

Tuttavia, poiché una errata regolazione di componenti particolarmente importanti può creare una situazione di pericolo, alcune di queste regolazioni sono riservate soltanto ai Centri Assistenza MV Agusta.



#### ATTENZIONE

Tutte le regolazioni devono essere effettuate a veicolo fermo.



(F) Regolazione specchietto retrovisore (§5.6.)

(A) Regolazione leva  
freno anteriore (§5.3.)

(H) Regolazione sospensione anteriore  
(§5.7.)

(M) Orientamento faro (§5.9.)

(D) Regolazione leva  
freno posteriore (§5.2.)

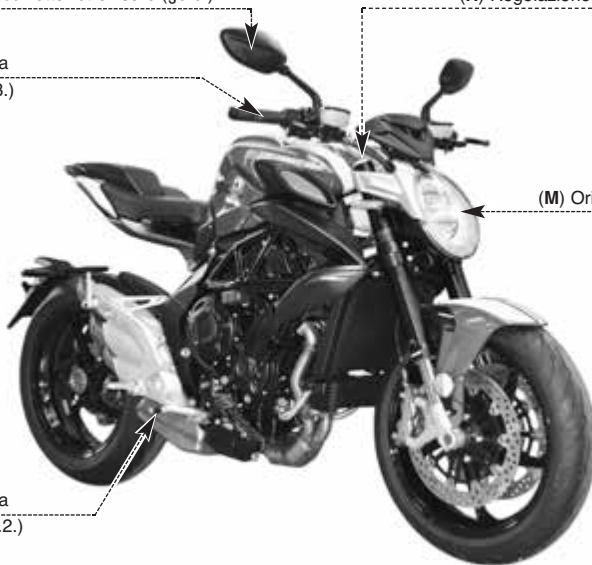





(F) Regolazione specchietto retrovisore (§5.6.)

(E) Regolazione ammortizzatore di sterzo  
(Brutale RR) (§5.5.)

(B) Regolazione leva  
frizione (§5.4.)

(L) Regolazione sospensione posteriore  
(§5.8.)

(C) Regolazione  
leva cambio (§5.2.)

(G) Regolazione catena (§5.2.)

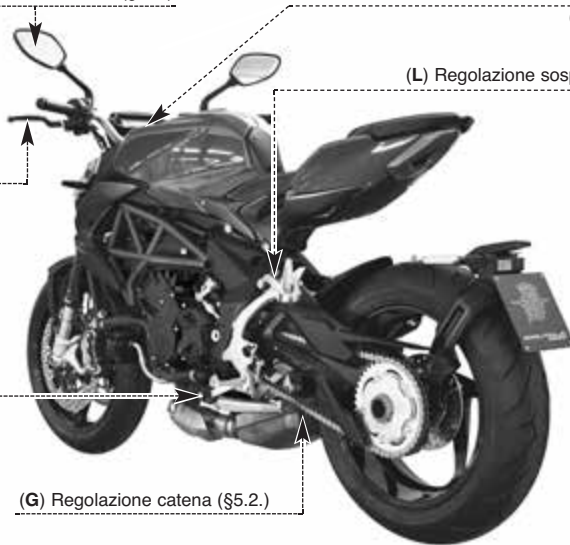



## 5.2. Tabella delle regolazioni

	<b>A - Regolazione leva freno anteriore:</b> per ottimizzare la presa in funzione delle esigenze del motociclista (§5.3).		<b>G - Regolazione catena:</b> per l'efficienza e la sicurezza della trasmissione.
	<b>B - Regolazione leva frizione:</b> per ottimizzare la presa in funzione delle esigenze del motociclista (§5.4).		<b>H - Regolazione sospensione anteriore:</b> per adattare la risposta alle preferenze del motociclista si possono regolare: <ul style="list-style-type: none"><li>- precarico molla (§5.7.1.)</li><li>- dispositivo idraulico di frenatura in estensione (§5.7.2.)</li><li>- dispositivo idraulico di frenatura in compressione (§5.7.3.)</li></ul>
	<b>C - Regolazione leva cambio:</b> per ottimizzare il movimento del comando in funzione delle esigenze del motociclista.		<b>L - Regolazione sospensione posteriore:</b> per adattare la risposta alle preferenze del motociclista si possono regolare: <ul style="list-style-type: none"><li>- altezza assetto</li><li>- precarico molla</li><li>- dispositivo idraulico di frenatura in estensione (§5.8.1.)</li><li>- dispositivo idraulico di frenatura in compressione (§5.8.2.)</li></ul>
	<b>D - Regolazione leva freno posteriore:</b> per ottimizzare il movimento del comando in funzione delle esigenze del motociclista.		<b>M - Orientamento faro:</b> per regolare la profondità del fascio luminoso in funzione dell'assetto (§5.9).
	<b>E - Regolazione ammortizzatore di sterzo (Brutale RR):</b> per adattare la durezza dello sterzo alle preferenze di guida del motociclista (§5.5).		
	<b>F - Regolazione specchietti retrovisori:</b> per ottimizzare l'orientamento (§5.6).		
	<b>ATTENZIONE:</b> Non intervenire sulla vite di fissaggio dello specchietto retrovisore al manubrio. In caso di necessità, rivolgersi ad un concessionario MV Agusta.		



### 5.3. Regolazione leva freno anteriore

Ruotare il registro di regolazione della leva per modificarne la posizione.

In senso orario: la leva si avvicina alla manopola.  
In senso antiorario: la leva si allontana dalla manopola.



5

### 5.4. Regolazione leva frizione

Ruotare il registro di regolazione della leva per modificarne la posizione.

In senso orario: la leva si avvicina alla manopola.  
In senso antiorario: la leva si allontana dalla manopola.

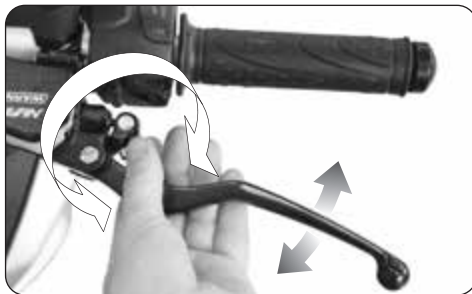



### 5.5. Regolazione ammortizzatore di sterzo (Brutale RR)

La regolazione standard si ottiene ruotando il pomello in senso antiorario fino a fondo corsa; in questa posizione l'ammortizzatore offre la minima resistenza all'azione dello sterzo.

In base alle proprie esigenze di guida è possibile aumentare gradualmente l'azione frenante dell'ammortizzatore di sterzo ruotando il pomello in senso orario.

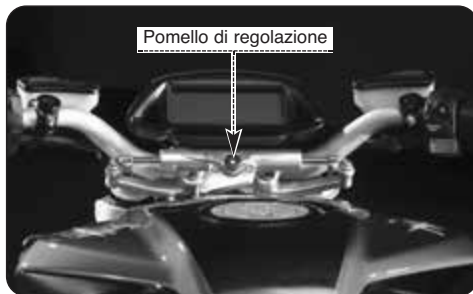



### 5.6. Regolazione specchietti retrovisori

Ruotare gli specchietti per regolarne la posizione nelle quattro direzioni.

Eseguire la regolazione su entrambi gli specchietti retrovisori. Per rendere ottimale la messa a punto si consiglia di eseguire la regolazione salendo sul veicolo.



5



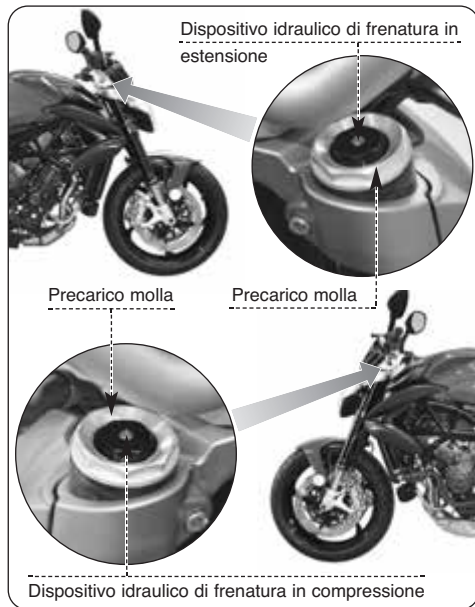

## 5.7. Regolazione sospensione anteriore

**NOTA:** La regolazione delle sospensioni deve essere preferibilmente effettuata con il serbatoio carburante pieno.

### 5.7.1. Prearico molla (sospensione anteriore)

La regolazione deve essere effettuata partendo dalla posizione standard. Per trovare tale posizione, occorre ruotare in senso antiorario fino a fondo corsa, quindi in senso orario fino alla posizione standard (vedi tabella allegata). Ruotare in senso orario per aumentare il prearico molla, oppure ruotare in senso antiorario per diminuirlo.



5



### 5.7.2. Dispositivo idraulico di frenatura in estensione (sospensione anteriore)

La regolazione deve essere effettuata partendo dalla posizione standard. Per trovare tale posizione, occorre ruotare in senso orario fino a fondo corsa, quindi in senso antiorario fino alla posizione standard (vedi tabella). Ruotare in senso orario per aumentare l'azione frenante, oppure ruotare in senso antiorario per diminuirla.

### 5.7.3. Dispositivo idraulico di frenatura in compressione (sospensione anteriore)

La regolazione deve essere effettuata partendo dalla posizione standard. Per trovare tale posizione, occorre ruotare in senso orario fino a fondo corsa, quindi in senso antiorario fino alla posizione standard (vedi tabella). Ruotare in senso orario per aumentare l'azione frenante, oppure ruotare in senso antiorario per diminuirla.





### 5.8. Regolazione sospensione posteriore



#### ATTENZIONE

L'ammortizzatore contiene gas ad alta pressione. Non tentare in alcun modo di effettuarne lo smontaggio.

**NOTA:** La regolazione delle sospensioni deve essere preferibilmente effettuata con il serbatoio carburante pieno.

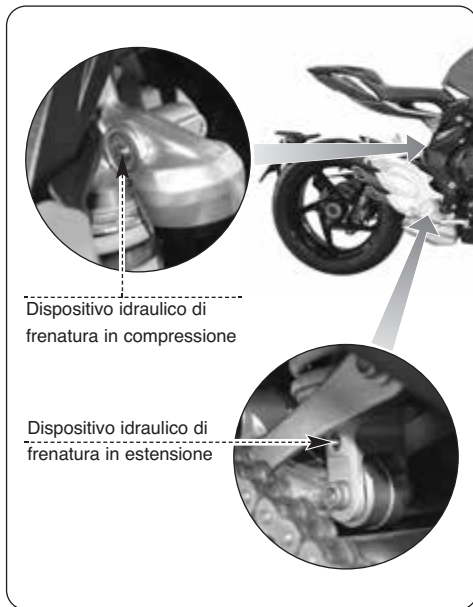





### 5.8.1. Dispositivo idraulico di frenatura in estensione (sospensione posteriore)

La regolazione deve essere effettuata partendo dalla posizione standard. Per trovare tale posizione, occorre ruotare in senso orario fino a fondo corsa, quindi in senso antiorario fino alla posizione standard (vedi tabella). Ruotare in senso orario per aumentare l'azione frenante, oppure ruotare in senso antiorario per diminuirla.

### 5.8.2. Dispositivo idraulico di frenatura in compressione (sospensione posteriore)

La regolazione deve essere effettuata partendo dalla posizione standard. Per trovare tale posizione, occorre ruotare in senso orario fino a fondo corsa, quindi in senso antiorario fino alla posizione standard (vedi tabella). Ruotare in senso orario per aumentare l'azione frenante, oppure ruotare in senso antiorario per diminuirla.

5





### 5.9. Regolazione proiettore anteriore

Porre il veicolo a 10 metri di distanza da una parete verticale.

Assicurarsi che il terreno sia piano e che l'asse ottico del proiettore sia perpendicolare alla parete.

Il veicolo deve trovarsi in posizione verticale. Misurare l'altezza del centro del proiettore da terra e riportare sulla parete una crocetta alla medesima altezza.

Accendendo la luce anabbagliante, il limite superiore di demarcazione tra la zona oscura e la zona illuminata deve risultare ad un'altezza non superiore a  $9/10$  dell'altezza da terra del centro del proiettore.

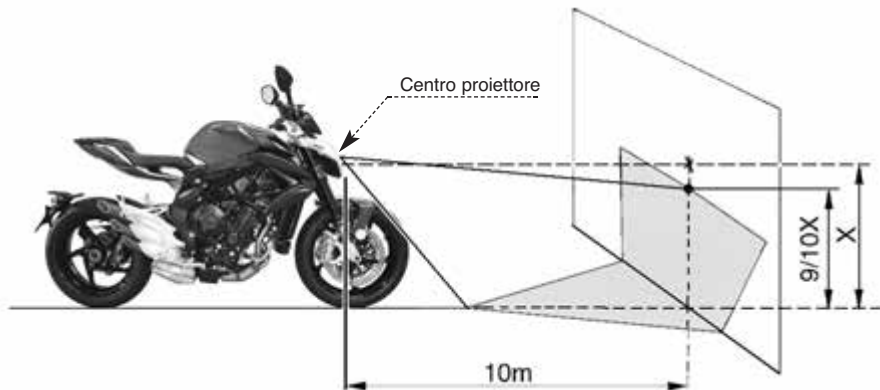



La regolazione del faro anteriore può essere effettuata agendo sulla vite raffigurata a lato. In senso orario: il faro si inclina verso il basso. In senso antiorario: il faro si inclina verso l'alto. L'inclinazione può essere variata di  $\pm 4^\circ$  rispetto alla posizione standard.

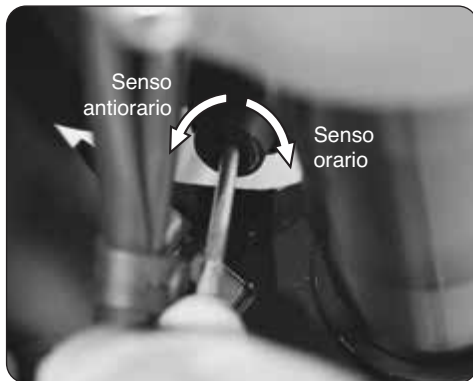



### Nota informativa

MV Agusta Motor S.p.A. è impegnata in una politica di continuo miglioramento dei propri prodotti; per questa ragione potrebbe essere possibile riscontrare leggere differenze tra quanto riportato nel presente documento ed il veicolo da Voi acquistato. I modelli MV Agusta vengono esportati in numerosi Paesi, nei quali valgono norme differenti in relazione al Codice della Strada ed alle procedure di omologazione. Contando sulla Vostra comprensione, MV Agusta Motor S.p.A. ritiene quindi necessario riservarsi il diritto di apportare modifiche ai propri prodotti ed alla propria documentazione tecnica in qualsiasi momento e senza fornire preavviso.

Vi consigliamo di visitare periodicamente il sito Internet **[www.mvagusta.it](http://www.mvagusta.it)** per ottenere informazioni ed aggiornamenti sui prodotti MV Agusta e sulla relativa documentazione.



### Rispettiamo e difendiamo l'ambiente

Tutto ciò che facciamo ha ripercussioni sull'intero pianeta e sulle sue risorse. MV Agusta, a tutela degli interessi della comunità, sensibilizza i Clienti e gli operatori dell'assistenza tecnica ad adottare modalità d'uso del mezzo e di smaltimento di sue parti, nel pieno rispetto delle normative vigenti in termini di inquinamento ambientale, smaltimento e riciclaggio dei rifiuti.

© 2017

È vietata la riproduzione anche parziale di questo documento senza il consenso scritto della MV Agusta Motor S.p.A.

Part. n° 8000C5107

Edizione n° 1 - Novembre 2017



**BRUTALE  
800-RR**

**MV AGUSTA**



User's manual  
*English Version*

*Dear Customer ,*

*We wish to thank you for your preference and congratulate you on purchasing your new Brutale. MV Agusta, thanks to the passionate effort of its technicians, offers to its customers a motorcycle with a new aesthetic design combined with a refined framework: these are the elements which have distinguished every vehicle created by MV Agusta throughout its glorious history.*

*The result of this effort is an exclusive motorcycle with functional and aesthetic characteristics that place it above the finest motorcycles currently available on the market, making it an exclusive and sought-after item.*

*In fact, the technologies and solutions applied give to the Brutale unique characteristics common to all the MV Agusta models, strenghtening a design phylosophy that involves continuous research, technological innovation and love for detail. This way, MV Agusta gives to all the bikers who freely live their passion the chance to possess a unique object, which surely represents a strong reference worldwide.*

*For further information, please feel free to contact the MV Agusta Customer Care Service.*

*Have a good time!*

*Giovanni Castiglioni  
MV Agusta  
Chairman*



# CONTENTS

<i>chap.</i>	<i>Subject covered</i>	<i>page</i>
<b>1</b>	<b>GENERAL INFORMATION</b>	<b>5</b>
1.1.	Purpose of the manual	5
1.2.	Symbols	6
1.3.	Delivery certificate	7
1.4.	Identification data	8
<b>2</b>	<b>SAFETY INFORMATION</b>	<b>11</b>
2.1.	Vehicle warranty	11
2.2.	Scheduled maintenance	12
2.3.	Vehicle load	14
<b>3</b>	<b>CONTROLS AND INSTRUMENTS</b>	<b>15</b>
3.1.	Location of controls and instruments	15
3.2.	Sidestand	17
3.3.	Handlebar controls, left side	18
3.4.	Handlebar controls, right side	20
3.5.	Ignition switch and steering lock	23
3.6.	Gear lever	26
3.7.	Instruments and warning lights	27
3.7.1.	Warning lights	28
3.7.2.	Multifunction display	29
3.8.	Table of lubricants and fluids	30

<i>chap.</i>	<i>Subject covered</i>	<i>page</i>
<b>4</b>	<b>OPERATION</b>	<b>31</b>
4.1.	Using the motorcycle	31
4.2.	Running-in	32
4.3.	Starting the engine	34
4.4.	Selecting & setting of the display functions	37
4.4.1.	Selecting the display functions	38
4.4.2.	Trip reset	43
4.4.3.	“SPEED LIMITER” Mode	45
4.4.4.	TC Mode	47
4.4.5.	Chronometer	48
4.4.6.	Selecting the ABS functions	57
4.4.7.	“QUICK SHIFT” Mode	59
4.4.8.	Clock settings	60
4.4.9.	“IMMOBILIZER” Mode	62
4.4.10.	How to select the mapping of the control unit	65
4.4.11.	Warning/malfunction alerts	77
4.5.	Refuelling	80
4.6.	Passenger saddle removal	82
4.7.	Driver’s saddle removal	83
4.8.	Parking the motorcycle	84





## CONTENTS

<i>chap.</i>	<i>Subject covered</i>	<i>page</i>
<b>5</b>	<b>ADJUSTMENTS</b>	<b>86</b>
5.1.	List of adjustments	86
5.2.	Table of adjustments	89
5.3.	Adjusting the front brake lever	90
5.4.	Adjusting the clutch lever	90
5.5.	Adjusting the steering damper (Brutale RR)	91
5.6.	Adjusting the rearview mirrors	92
5.7.	Adjusting the front suspension	93
5.7.1.	Spring preload (front suspension)	93
5.7.2.	Rebound damper (front suspension)	94
5.7.3.	Compression damper (front suspension)	94
5.8.	Adjusting the rear suspension	95
5.8.1.	Rebound damper (rear suspension)	96
5.8.2.	Compression damper (rear suspension)	96
5.9.	Headlight adjustment	97



### 1.1. Purpose of the manual

This User's Manual contains the necessary information for a correct and safe use of the motorcycle.

The User's Manual is also supplied in electronic format (.pdf) on this digital support and it can be printed or viewed on any PC, equipped either with Windows or Mac operative system.

We recommend to carefully read the User's Manual before using your motorcycle, and to make sure that anyone who uses the motorcycle had previously made the same.

The supplied digital media includes this manual, the Maintenance Manual, the Dealer Guide and the Warranty Booklet.



Copyright  
MV AGUSTA Motor Spa  
All rights reserved



## 1.2. Symbols

Sections of text that are particularly important in terms of personal safety or possible damage to the motorcycle are marked with the following symbols:



**Danger - Failure to observe these prescriptions, even in part, may pose a serious hazard to the driver's and other people's safety.**



**Caution - Failure to observe these prescriptions, even in part, may result in damage to the motorcycle.**

The following symbols give an indication of who is supposed to perform the different adjustments and/or maintenance operations:



**Information on operations that can be carried out by the user.**



**Information on operations that must be carried out only by authorized personnel.**

The following symbols are used to provide further information:



**The “” symbol points out the requirement to use a tool or a special equipment in order to correctly perform the described operation.**



**The “§” symbol refers the reader to the chapter identified by the number that follows.**



### 1.3. Delivery certificate

When delivering the bike, your Dealer has also supplied the Warranty and Pre-Delivery Certificate.

We recommend to keep it together with the motorcycle documents and with the service coupons that are given at the moment of servicing the bike.

#### **IMPORTANT**

The copies of the Warranty and Pre-Delivery Certificate must be filled in by the Dealer. A copy of the certificate must be given to the Customer, a second copy must be kept by the Dealer and the third one must be sent to the importer.

The Dealer must always fill in the recommended maintenance service coupons. They must be kept by the Customer.

GB  
1

#### 1.4. Identification data

- 1) vehicle identification number
- 2) engine serial number
- 3) homologation data

##### ► Motorcycle identification

The motorcycle is identified by the vehicle identification number. When placing orders for spare parts, in addition to this number, you may be required to provide the engine serial number, the color code and the key identification.

We recommend writing down the main numbers in the spaces provided below.

**FRAME No.:** \_\_\_\_\_

**ENGINE No.:** \_\_\_\_\_



## ► **Motorcycle key identification**

A key is supplied in duplicate for both the ignition and all the locks. Keep the duplicate in a safe place.

When placing orders for spare keys, you may be required to provide the key identification number. The key identification number is found on the MV Code Card supplied with the ignition keys.



1 GB

## ► **Identification of motorcycle colour combination**

The colour code must be mentioned when ordering body spares. It can be read on the rear lower side of the fuel tank.

In order to get to the colour code label, it is necessary to remove the pillion and the driver's saddle as described in paragraphs §4.6. and §4.7.





GB  
1

After removing the saddles, it is possible to get to the colour code label. On this label you can read the motorcycle colour combination, which determines the painting of the bodywork parts.

We recommend writing down the colour code in the space provided below:

**COLOUR CODE:** .....

To get the reference colours of the painted parts according to the motorcycle colour code, refer to the Maintenance Manual included on the supplied digital media.

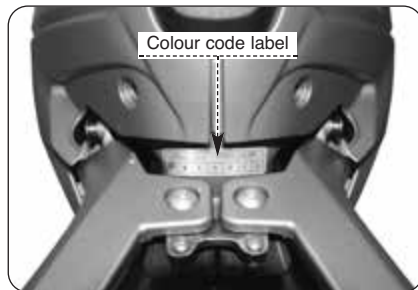



## 2.1. VEHICLE WARRANTY



### WARNING

Please note that the warranty is not valid if the vehicle is used for racing on track or on public roads, since this is a use other than and incompatible with the on-road use for which your vehicle has been specifically designed. Furthermore, the warranty is not valid if the vehicle is used for professional activities, including, but not limited to, taxi services, rental, etc.

Furthermore, remember that MV Agusta reserves the right to assess the validity of the warranty in all cases, with no exclusions, where it is ascertained that your vehicle was modified compared to its original configuration, this also includes use of spare parts and/or genuine MV Agusta accessories fitted by the customer service at a MV Agusta dealer.

We also highlight that the warranty is not valid when any alteration, be it for maintenance certificates or any other repair, setup, replacement or other types of operations, is performed by workshops and/or technicians and/or service and repair centres and, generally, by any third party that does not operate according to the technical and procedural standards that MV provides to its qualified technical personnel for vehicle maintenance (technical courses; workshop-specific equipment; manuals; genuine spare parts, etc.) and/or does not use genuine spare parts and/or accessories supplied by MV Agusta.

In any case the warranty does not cover wear parts or parts that are subject to deterioration (lubricants and liquids, spark plugs, clutch, filters, chain, crown wheel, pinion, brake pads, brake discs,





tyres, pipes and rubber parts, battery, light bulbs and fuses), events caused by improper use and/or negligence and/or exposure to atmospheric agents (paint fading, corrosion, etc...) and/or exceeding the loading limits set out in the vehicle operating manual.

Remember that, as required by law, this warranty is provided directly by your MV Agusta dealer. Please contact the dealer for any needs. The warranty is valid also overseas at any other MV Agusta network dealer.

## 2.2. SCHEDULED MAINTENANCE



### WARNING

Remember that, if your vehicle breaks down or malfunctions due to failure to perform the maintenance certificates, your dealer may refuse to operate under warranty and at the same time the dealer and MV Agusta S.p.A. may not be considered liable for any damage incurred by the vehicle and/or by the user and/or by third parties and/or by third party property, due to these breakages or malfunctions.

All maintenance certificates, including the first one, will require payment for both materials and labour.

MV Agusta recommends that any operation on the vehicle, whether it is maintenance certificates or any other repair operation, set up, replacement or any other operation, is performed at the autho-



rised workshops of the MV Agusta dealers according to the methods described in the maintenance manual, in the workshop manual and in any technical bulletin published by MV Agusta S.p.A., since MV Agusta ensures proper execution of any operation only if this is performed at the authorised workshops of the MV Agusta dealer that operate according to technical and procedural standards set out by MV Agusta and only use genuine spare parts and accessories.

After each compulsory maintenance certificate, always check that the relative certificate is stamped and signed by the dealer and check that the operation performed meets your expectations. The certificates are located at the end of the warranty booklets.

Always store the warranty booklets containing the certificates stamped by the MV Agusta dealer and the relative tax invoices and deliver it to the new purchaser in the events the vehicle is transferred.

### Due dates for the scheduled maintenance operations

Km (mi) covered*	1000 (600)	Every year	15000 (9000)	30000 (18000)	45000 (27000)	60000 (36000)	75000 (45000)	90000 (54000)	105000 (63000)
Service coupon	A		B	C	D	E	F	G	H

(\*): The mileage coupons can be carried along with the **mandatory** annual coupon



### 2.3. VEHICLE LOAD

Your motorcycle is designed for use by the rider and it can also seat a passenger.

To use the vehicle in complete safety and in accordance with the Highway Code provisions, it is compulsory that the following maximum load conditions are never exceeded:

#### BRUTALE 800 - RR

Maximum technically permissible mass

**379 kg**

Maximum load mass

**180 kg**

The maximum technically permissible mass comes out from the sum of the following masses:

- mass of the motorcycle;
- mass of the driver;
- mass of the passenger;
- mass of the luggage and all the accessories.



#### WARNING

Since the load can strongly affect handling, braking, performance and safety characteristics of your motorcycle, you should always keep in mind the following warnings.

- **NEVER OVERLOAD YOUR MOTORCYCLE!** Driving an overloaded motorcycle can cause damage to the tyres, loss of control of the vehicle and serious injury. Verify that the total weight (including the weight of the motorcycle, the driver, the passenger, the load and all the accessories) does not exceed the maximum value specified for your vehicle.



## 3.1. Location of controls and instruments

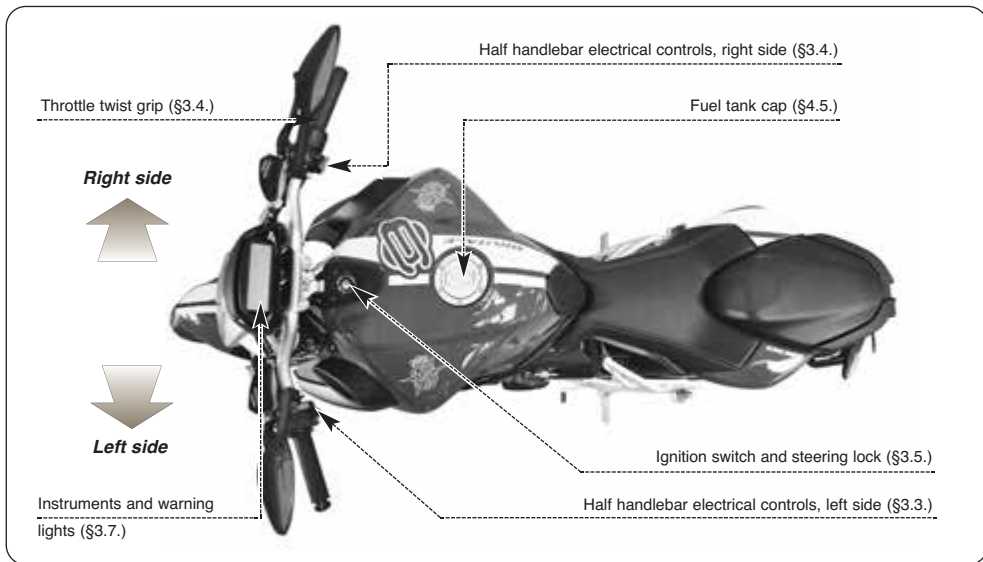



GB  
3

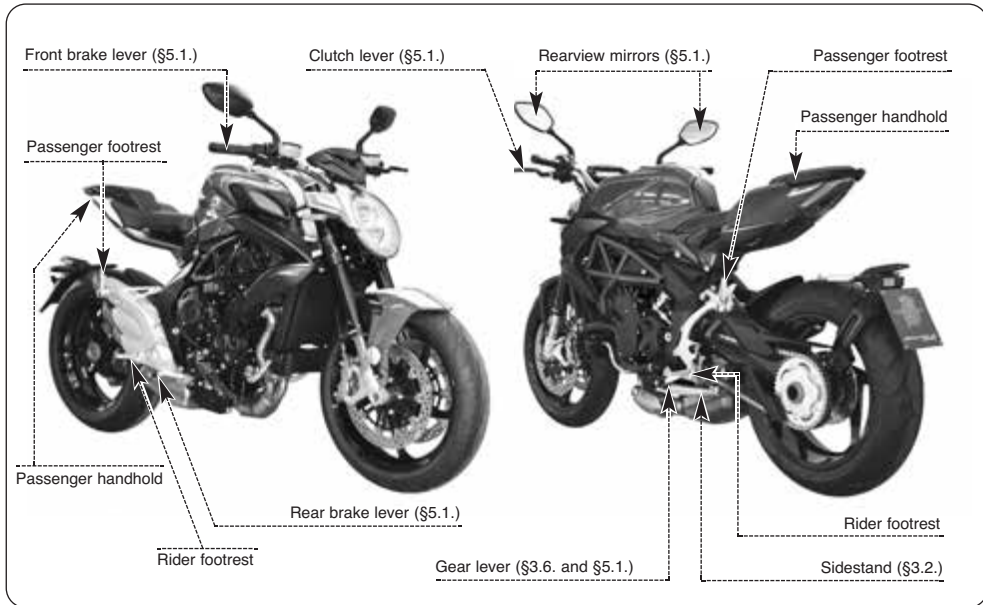



## 3.2. Sidestand

The sidestand is equipped with a safety switch that prevents the motorcycle from moving off while the stand is down.

If the rider attempts to engage the gears while the engine is running and the stand is down, the switch automatically turns off the engine by cutting the current supply.

If the motorcycle is parked (sidestand down) and the gears are engaged, the switch prevents the engine from being started, thereby avoiding the risk of accidentally toppling the vehicle.





## 3.3. Handlebar controls, left side

GB 3

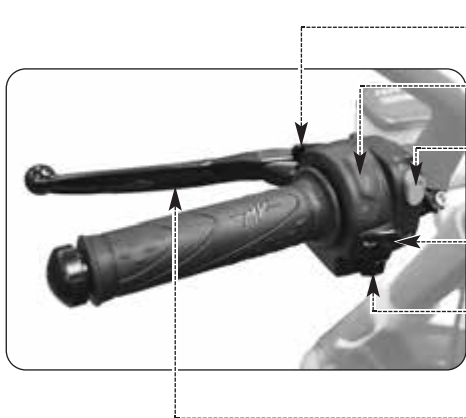

### **High beam flasher button**

Press the button repeatedly.

### **SET/OK button**

Press to change the dashboard functions (§ 4.4).

### **Low/high beam button**

Button not pressed in  : low beam

Button pressed in  : high beam

### **Horn button**

Press to operate the warning horn.

### **Turn indicator switch**

Shifting the lever to the left or right switches on the left or right turn indicators. The switch then returns to the central position.

Press to turn off the indicators.

### **Clutch lever**

Move towards/away from the handgrip to release/engage the clutch.



### High beam flasher button

It is used to attract the attention of other road users in case of danger. When the high beam is on, the function is inactive.

### SET/OK button

The SET button selects the various functions of the display to perform adjustments, while the OK button confirms the set values.

### Low/high beam button

Under normal conditions, the low beam is on. The high beam can be switched on by pressing the button when allowed by the traffic and road conditions.

### Turn indicator switch

It is used to show the rider's intention to change direction or lane.



#### WARNING

**Failure to switch the turn indicators on or off at the right time may cause an accident in that the other road users may draw incorrect conclusions about the direction of motion of the vehicle. Always switch on the indicators before turning or changing lanes. Then be sure to switch off the indicators after completing the operation.**

### Horn button

It is used to attract the attention of other road users in case of danger.

### Clutch lever

It engages/disengages the clutch.





## 3.4. Handlebar controls, right side

### **Emergency light button**

Press to activate or deactivate the emergency lights.

### **“Engine Map” button**

Press to set the engine mapping (§4.4.10.).

### **Engine stop switch**

Stops the engine and prevents it from being restarted.

### **Engine start button**

Starts the engine. To be released as soon as the engine starts.

### **Throttle twist grip**

Rotate counterclockwise to increase engine speed.

### **Night/day light lever (DRL) \***

Move the lever upward or downward to activate the night lights (high/low beam) or the day clearance lights (Day Running Lights).

### **Front brake lever**

Pull to the lever to apply the front brake.

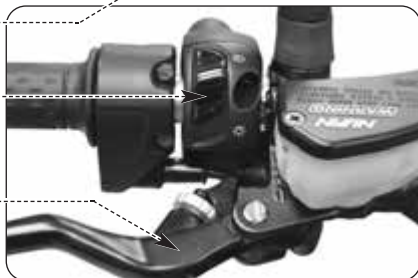
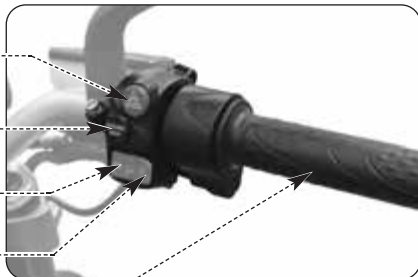

(\*): Japanese and Australian versions excluded



### Emergency light button

It is used to attract the attention of other road users in case of danger.

### “Engine Map” button

This button automatically selects the engine mapping (see §4.4.10).

### Engine stop switch

It is used to switch off the engine. The ignition circuit is disabled, preventing the engine from being restarted. To be able to restart the engine, return the switch to its original position.

**NOTE: Under normal conditions, use this switch to shut off the engine.**

### Engine start button

It is used to start the engine and, when the engine is running, to select the different functions of the display installed on the instrument panel.



#### CAUTION

**To avoid damaging the electrical equipment, be sure not to hold down the button for longer than 5 consecutive seconds. If, after some attempts, the engine does not start, refer to the chapter “TROUBLESHOOTING” in the “Maintenance Manual”.**

### Throttle twist grip

It controls the fuel-air mixture supplied to the engine, which regulates engine speed. To increase engine speed, rotate the hand grip from its idle position counterclockwise.



#### WARNING

**In the event that your bike has dropped or has been involved in an accident, bring the vehicle to an authorized MV Agusta service center to check the operation of the throttle grip before resuming the march.**

**Night/day light lever (DRL) \***

This device alternatively activates the day light devices (Day Running Lights) or the night devices (high/low beam - see §3.3), according to the external light conditions.

**Front brake lever**

It controls a hydraulic circuit that operates the front wheel braking system.

**□ Antilock Braking System (ABS)**

Brutale models are equipped with a power-assisted braking system (ABS - Antilock Braking System), which prevents the wheels from locking up during emergency brakings, thus guaranteeing the stability of the vehicle and shortening braking distances.



**WARNING:** When the ABS system is activated, vibrations could be perceptible through the brake lever or brake pedal. When this event occurs, it is recommended to keep pressed the braking control devices in order to allow the vehicle to complete the braking.



**WARNING:** If the ABS system has a fault or is deactivated, the related warning light on the dashboard turns on (see § 3.7.1.). From this moment on, the antilock braking system could not be available when braking. If there is a fault in the ABS system, it is recommended to resume riding at reduced speed and contact a MV Agusta authorized service centre. If the ABS system is turned off, follow the activation procedure described at § 4.4.6.

*(\*): Japanese and Australian versions excluded*



## 3.5. Ignition switch and steering lock



### WARNING

Do not attach a ring or any other object to the ignition key as they may hinder the steering action.



### WARNING

Never attempt to change the switch functions while riding, as you may lose control of the vehicle.

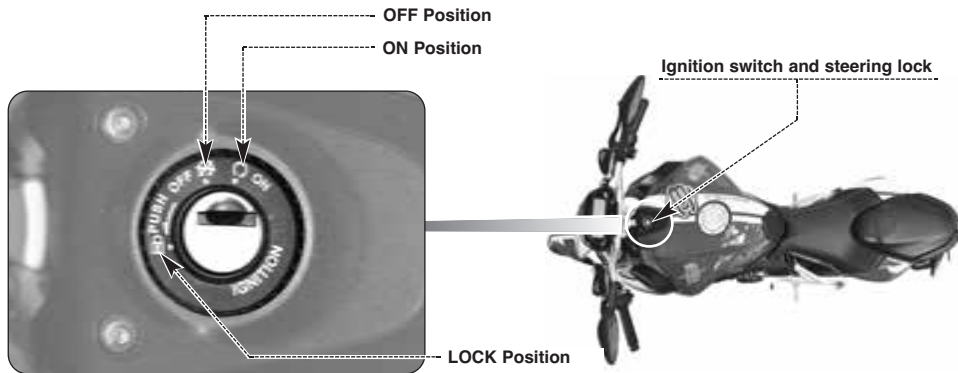



The ignition switch enables and disables the electrical circuit and the steering lock. The four positions of the switch are described below.

## OFF position

All electrical circuits are deactivated. The key can be removed.

## ON position

All electrical circuits are activated. The instruments and warning lights perform the self-diagnostic cycle. The engine can be started. The key cannot be removed.



**CAUTION:** Do not leave the key on the ON position for a long time when the engine is not running, in order to avoid damage to the electrical parts of the motorcycle



## LOCK position

Turn the handlebar to the left. Press the key in gently while rotating it to the LOCK position. All electrical circuits are deactivated and the steering is locked. The key can be removed.

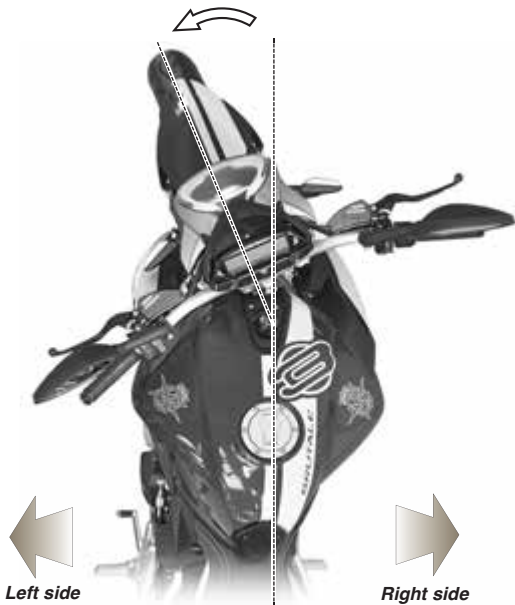

3 GB



### 3.6. Gear lever

The **N** (neutral) position is indicated by the warning light on the instrument panel.

To change into first gear, push the lever down.

To change into second gear, lift the lever up. Lifting the lever up repeatedly engages all the other gears in succession up to the sixth speed.



#### □ “Quick Shift” function

The Brutale models are equipped with a “Quick Shift” gear change system; this device enables you to upshift or downshift without pulling the clutch or changing the throttle control angle. This way, it is possible to change into upper or lower gears by keeping a constant acceleration and reducing shifting time to a minimum.



**WARNING:** The “Quick Shift” system is not available in the following conditions:

- when you change gear with the clutch lever pressed;
- when the vehicle travels at a speed lower than 30 km/h;
- if the gear lever is not in its proper starting position when changing gear.

Besides, when you are riding the vehicle with the engine revving high in a low gear, changing gear without operating the clutch lever can cause abrupt reactions which can compromise the stability of the vehicle. MV Agusta recommends to operate the clutch lever in all the above circumstances, especially when the engine rpm is close to the rpm-limiter intervention speed.



## 3.7. Instruments and warning lights

The instruments and warning lights are activated by turning the ignition switch to the ON position. After a preliminary check (approx. 7 seconds) the displayed information reflects the current general condition of the motorcycle.

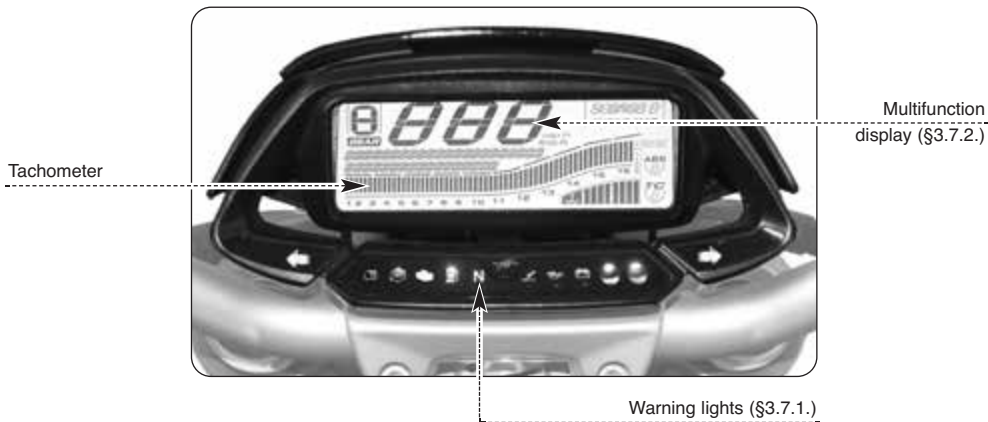





### 3.7.1. Warning lights

#### ABS warning light (red)

Lights up when the ABS system has a fault or is deactivated, or if the speed is lower than 5 km/h.

 **WARNING:** If the warning light comes on while riding, stop the motorcycle immediately and check that the ABS system is activated (see §4.4.6.). In this case, resume riding at reduced speed and contact a MV Agusta authorized service centre.

#### High beam (blue)

It turns on when the high beam is on.

#### Engine light (yellow)

This turns on when an engine malfunction occurs.

#### Reserve fuel indicator (orange)

Comes on when approximately 4 litres of fuel are left.

#### Neutral warning light (green)

It turns on when the gear is in "Neutral".

#### Sidestand down warning light (red)

Lights up when the sidestand is down.

#### Engine oil pressure warning light (red)

Lights up when the oil pressure is insufficient.



**WARNING:** If the warning light comes on while riding, stop the motorcycle immediately. Check the oil level and if necessary have it restored by a MV

Agusta authorized service centre (see §3.8.). If the warning light comes on even if the oil level is correct, do not resume riding and contact a MV Agusta authorized service centre.

#### Turn indicator lights (green)

They light up when the turn indicators are activated.

#### RPM limiter indicator (red)

It switches on before the limiter intervention, at a rpm number dependent on the ratio of the inserted gear. The limiter intervenes at 13000 rpm.

#### "Warning" light (orange)

This turns on when a fault occurs. If ignition occurs while driving, contact an authorized service center.

#### Battery charge indicator (red)

Lights up when the alternator does not supply enough current to charge the battery.

If the indicator comes on while riding, contact an authorized service centre.

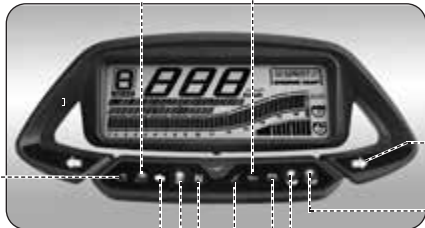



## 3.7.2. Multifunction display

### Speedometer

It displays the speed of the motorbike. It can be given in kilometres per hour (Km/h) or in miles per hour (Mph). The full scale measures 300 Km/h (186 Mph).

### Gear display

It displays the currently engaged gear. The "0" digit stands for "neutral".

### "TOTAL" odometer

It displays the total distance covered; from 0 to 999999 (Km or miles)

### Trip counter 1, "TRIP 1"

It displays the length of a trip; from 0 to 999.9 (Km or miles)

### Trip counter 2, "TRIP 2"

It displays the length of a trip; from 0 to 999.9 (Km or miles)

### Chronometer

It displays the time measured by the chronometer

### ABS display

Indicates the activation state of the ABS function.

### Traction control level display

Indicates the traction control level currently selected.

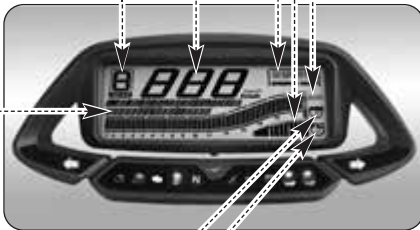

### Control unit mapping display

Indicates the control unit mapping currently selected.

### Clock

Indicates the current time.

### Thermometer

It displays the temperature of the coolant by turning on a variable number of segments on a graduated scale. When the temperature falls outside the normal operating range, it may display one of the following information:

- the display shows just one blinking segment; it means that the temperature is low;
- all segments are on, while the upper segment is blinking; it means that the temperature is high.



**Danger - Notice:** if the temperature is high, stop the motorbike and check the coolant level. If it needs to be filled up, contact a MV Agusta licensed service centre (see § 3.8). If the warning light turns on even if the level is adequate, stop driving and contact a MV Agusta licensed service centre.

**3.8. Table of lubricants and fluids**

<i>Description</i>	<i>Recommended product</i>	<i>Specifications</i>
Engine lubrication oil	Motul 7100 4T 5W40 (*)	SAE 5W/40
Coolant	Motul Motocool Factory Line	Product based on monoethyleneglycol Ready to use - Do not add water
Brake and clutch fluid	Motul DOT 3 & 4 Brake Fluid	DOT4
Drive chain lubrication oil	Motul Chain Lube Road	–

\* : MV Agusta suggests to refer directly to its authorized dealers in order to purchase the recommended product. The Brutale motorcycle engine has been developed with Motul 7100 4T 5W40 engine oil. If the above described lubricant is not available, MV Agusta suggests to use a fully synthetic engine oil having characteristics equal or better than the ones prescribed in the following standards:

- Consistent with: API SN / SM
- Consistent with: JASO MA2
- SAE Rating: SAE 5W40

**NOTE**

The above standard denominations must be written, alone or together, on the engine oil container label.





#### 4.1. Using the motorcycle

This section provides the basic information needed to correctly operate the motorcycle.



##### **WARNING**

Your motorcycle Brutale shows high power and performance characteristics; therefore, its use requires an adequate level of knowledge of the vehicle. When you use this motorcycle for the first time, it is essential to adopt a cautious attitude. An aggressive or reckless riding attitude can lead to accidents, compromising the driver's and other people's safety.



##### **WARNING**

THE RESTRICTIONS RELATED TO THE ALLOWED USE OF THE VEHICLE ARE DESCRIBED IN THE SECTION "SAFETY INFORMATIONS".



## 4.2 Running-in



### CAUTION

Failure to observe the indications provided below can reduce performance and shorten the life of the motorcycle.

Running-in is generally considered to apply only to the engine. In fact, it should be regarded as an essential phase for other important parts such as the tyres, the brakes and the drive chain. During the very first miles, adopt a relaxed riding style.

#### □ 0 to 500 km (0 to 300 mi) (A)

Frequently change the engine speed. If possible, prefer hilly routes with gentle slopes and many bends. Avoid long straight stretches.



### WARNING

New tyres must undergo a proper running-in period to reach their complete efficiency. Avoid abrupt acceleration, turning and braking during the first 100 km. Failure to observe these prescriptions can lead to the sliding of the wheels and the loss of control of the vehicle with subsequent risk of accidents.



❑ **500 to 1000 km (300 to 600 mi)**

Avoid lugging or overspeeding the engine, and vary your speed frequently.



❑ **1000 to 2500 km (600 to 1600 mi)**

Higher engine performance can be demanded, but it is advisable not to exceed the engine speed shown in the figure.





### 4.3. Starting the engine



**WARNING:** Starting the engine in a closed place can be dangerous. Exhaust emissions contain carbon monoxide, a colourless and odourless gas that can lead to serious harm or even death when inhaled.

Only start the engine outdoor, in the open air.

► As you turn the ignition switch to the ON position, the instruments and the warning lights will go through the self-diagnostic cycle; during this phase, make sure that all the warning lights on the dashboard come on.

► The start/stop system will let the motorbike turn on if one of the following conditions is met:

- The gear is in neutral with the clutch lever up.
- The gear is engaged with the clutch lever up and the side stand up.

**NOTE:** When less than 1000 km are left to the execution of the next scheduled maintenance intervention, the notice screenshot shown here on the side appears on the display.





- ▶ If the self-diagnostic cycle detects a fault in the vehicle, the display shows the warning alert shown in the picture. In particular, this message highlights the vehicle part or device on which the fault has been detected.



4 GB

- ▶ Press “OK” button to access to “RUN” mode.

**WARNING**

If a fault is detected on the vehicle, do not start engine and contact an authorized MV Agusta centre.







### □ Engine start procedure

- ▶ Press the start button without turning the throttle twist grip.
- ▶ As soon as the engine starts, release the button.



### CAUTION

- Do not press the start button for longer than 5 consecutive seconds, in order to avoid damage to the electrical equipment.
- Avoid warming up the engine while the vehicle is stationary. The subsequent engine overheating can cause damage to the internal parts of the engine. It is advisable to bring the engine to the working temperature by riding at reduced speed.
- To ensure the maximum life of the engine, never speed up at full throttle when the engine is cold.

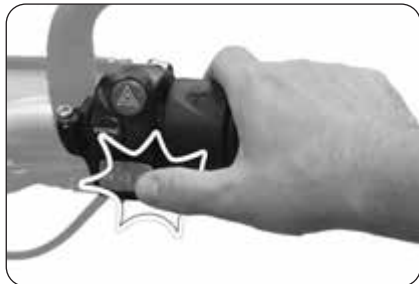



#### 4.4. Selecting and setting the display functions

Some of the main measurements of the instruments may be changed.

The available options include:

- Select an operating mode:
  - “RUN” (Odometer)
  - “SPEED LIMITER”
  - “TC” (Traction control)
  - “CHRONO” (Chronometer)
  - “ABS” (Antilock braking system)
  - “QUICK SHIFT”
  - “CLOCK” (Clock)
- Reset the trip counter:
  - Trip counter 1      “TRIP 1”
  - Trip counter 2      “TRIP 2”
- Turn on the chronometer
- Clock settings
- “IMMOBILIZER” mode (Antitheft device)
- Control unit mapping selection





#### 4.4.1. Selecting the display functions

The following settings may be changed on the display:

- “RUN” (Odometer)
- “SPEED LIMITER”
- “TC” (Traction control)
- “CHRONO” (Chronometer)
- “ABS” (Antilock braking system)
- “QUICK SHIFT”
- “CLOCK” (Clock)

To display the operating modes, press “SET” for less than three seconds. When pressed, the display shows all modes in a sequence. Select the desired mode.



#### WARNING

The operation must be performed while the engine is not running, the gears are in neutral, the motorcycle is stationary, and with the feet on the ground. Do not set the display functions while riding, except where otherwise indicated.



#### ❑ “RUN” mode

In addition to the speedometer, the display shows the following functions (see §4.4.2.):

- Total odometer “TOTAL”
- Trip counter 1 “TRIP 1”

As an alternative:

- Total odometer “TOTAL”
- Trip counter 2 “TRIP 2”

#### ❑ “SPEED LIMITER” mode

This mode adjusts the maximum value of the vehicle speed to your driving requirements (see §4.4.3.).



4 GB



#### ❑ “TC” Mode

This Mode adjusts the engine traction control level to your driving requirements (see §4.4.4.).



#### ❑ “CHRONO” Mode

This mode turns on the Chronometer and saves the recorded information (see §4.4.5.).

The following is displayed:

- |               |                    |               |
|---------------|--------------------|---------------|
| • Chronometer | Current lap        | “CURRENT LAP” |
| • Chronometer | Fastest lap        | “BEST LAP”    |
| • Chronometer | Last lap           | “LAST LAP”    |
| • Rev counter | Total laps covered | “N° LAP”      |





#### ❑ “ABS” Mode

This mode allows to activate or deactivate the antilock braking system (ABS) (see §4.4.6.).



#### ❑ “QUICK SHIFT” mode

This mode allows to turn off or on the “quick shift” function of the gear change (see §4.4.7.).





□ **“CLOCK” Mode**

The present function enables to change the time (hours and minutes) reported on the dashboard (see §4.4.8.).





#### 4.4.2. Trip reset

To reset “TRIP 1” and “TRIP 2”, proceed as follows.



#### WARNING

The display modes may be changed or set when the engine is off, the gear in neutral, the motorbike stationary with your feet on the ground. The display may not be changed while driving.

- ▶ Access the “RUN” mode; the total speedometer (“TOTAL”) and partial speedometer 1 (“TRIP 1”) will appear on the display.
- ▶ By pressing the “OK” key for more than three seconds, the “TRIP 1” value will be reset to zero.







► Press the “OK” key for less than three seconds until the partial speedometer 2 function (“TRIP 2”) appears on the display.



► By pressing the “OK” key for more than three seconds, the “TRIP 2” value will be reset to zero.





#### 4.4.3. "SPEED LIMITER" mode

When starting the engine, the "SPEED LIMITER" function is disabled. In order to activate it, it is necessary to perform the following operations:

- ▶ Press "SET" in order to access to "SPEED LIMITER" mode. The maximum speed value shown on the display (equal to the current speed of the vehicle) starts blinking.

**NOTE:** The maximum speed may be changed or set even during the use of the vehicle.

- ▶ Press "SET" for less than three seconds: the maximum speed value is decreased of **2 km/h** with reference to the one shown on the display. On the other hand, if you press "OK" for less than three seconds, the maximum speed value is increased of **2 km/h** with reference to the one shown on the display.





- ▶ Press “OK” for over three seconds to confirm the selected maximum speed value. The displayed digit stops blinking and the display returns to “RUN” mode.
- ▶ On the other hand, if you press “SET” for over three seconds, the “SPEED LIMITER” function is disabled. The display shows the “OFF” caption. After three seconds, the display returns to “RUN” mode.

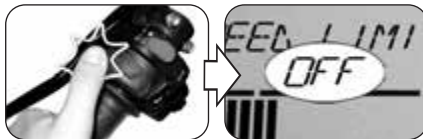

- ▶ If the “SPEED LIMITER” function has been enabled, when riding the vehicle the speed value shown on the odometer starts blinking when it reaches the set value of the maximum speed.



#### 4.4.4. "TC" mode

► Press "SET" in order to access to "TC" mode, then press "OK" for less than three seconds until "TC LEVEL" appears. The current traction control level is the same as the one shown on the display.



#### NOTE

**The traction control level may be changed or set even during the use of the vehicle.**

► Press "OK" for less than three seconds: the traction control level rises up to the next value. On the other hand, by pressing "SET" for less than three seconds, the traction control level decreases to the lower value. Such value may range between **0** and **8**.

► Press "SET" for over three seconds to confirm the selected traction control level.



4 GB



#### 4.4.5. Chronometer

##### □ Lap time recording

▶ Turn on the chronometer (“CHRONO” mode) to record the time taken to cover a lap.



▶ Press the headlight button to start recording the time. The colon that separates the minutes from the seconds and from the tenths of a second will start blinking. Now, the instrument is recording the time.

**NOTE:** When the “CHRONO” mode is activated, the first pressing of the headlight button automatically enables the “TC” function. From this moment on, it is possible to immediately change the traction control level by properly operate the “SET” and “OK” buttons (see §4.4.4.).





► Press the headlight button again to record the time taken to cover the 1st lap. At the same time, the instrument starts recording the time taken to cover the second lap.

The time measurement for the first lap is stored in the memory and is visualised on the display for ten seconds, after which the time measurement for the following lap appears.

► If using the chronometer again, every time you press the headlight button, it records a time. The instrument can record up to 100 consecutive times.

When the time for the lap which has just concluded is displayed, the symbol “+” or “-” appears if the time recorded is respectively higher or lower than the time measured during the previous lap.





#### ❑ Data display

Once all times have been recorded, they may be displayed.

- ▶ Access the “CHRONO” mode; the time of the fastest lap (“BEST LAP”) and the time of the last lap (“LAST LAP”) appears on the display.



#### WARNING

The display modes may be changed or set when the engine is off, the gear must be in neutral, the motorbike must be stationary with your feet on the ground. Do not change the display while driving.

- ▶ Press “OK” for less than three seconds until “LAPS VIEW” appears.





► By repeatedly pressing the key of the flashing high beam headlight, all the times previously acquired starting from the last lap memorised can be displayed in sequence.

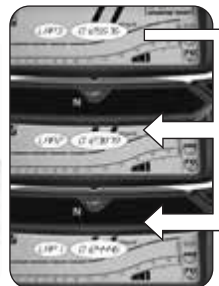

► Once all the data have been displayed, press the "SET" key to return to the "LAPS VIEW" mode and then to the following mode.



4 GB





#### ❑ How to delete data

To delete the saved data, proceed as follows:



#### WARNING

The display modes may be changed or set when the engine is off, the gear in neutral, the motorbike stationary with your feet on the ground. Do not change the display while driving.

► *Resetting of individual time recordings:* Access the “CHRONO” mode and press the “SET” key for less than three seconds until the words “SINGLE LAP RESET” appear on the display.

► Press the “OK” key for less than three seconds; the value of the last lap time memorised will start flashing.





► Now, press “OK” for over three seconds to delete the value. Otherwise, press “SET” for less than three seconds to stop the deletion procedure.

► Subsequently, by pressing the flashing high beam headlight key followed by the “OK” key for more than three seconds, all the previously acquired times can be cancelled.

► Once all the data have been cancelled, press the “SET” key to return to the “SINGLE LAP RESET” mode and then to the following mode.





► *Resetting of best lap time:* Access the “CHRONO” mode and press the “SET” key for less than three seconds until the words “BEST LAP RESET” appear on the display.



► Press the “OK” key for less than three seconds; the value of the fastest last lap time memorised will start flashing.





► Now, press “OK” for over three seconds to delete the value. Otherwise, press “SET” for less than three seconds to stop the deletion procedure.

► Once all the data have been cancelled, press the “SET” key to exit the “BEST LAP RESET” mode and then pass to the following mode.

► *Resetting of all lap times recorded:* Access the “CHRONO” mode and press the “SET” key for less than three seconds until the words “ALL LAPS RESET” appear on the display.”.

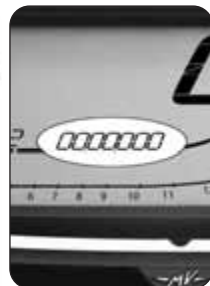



▶ Press the “OK” key for less than three seconds; the display will ask you to confirm cancellation of all the data present in the memory.



▶ By pressing the “OK” key for more than three seconds, all the previously acquired times will be cancelled. By pressing the “SET” key for less than three seconds, the cancellation procedure will be interrupted.

▶ Once all the data have been cancelled, press the “SET” key to exit the “ALL LAPS RESET” mode and to return to the “CHRONO” mode.





#### 4.4.6. Selecting the ABS functions

- ▶ Press “SET” in order to access to “ABS” mode; “SETTING ABS” appears on the display.



#### WARNING

The display modes may be changed or set when the engine is off, the gear in neutral, the motorbike stationary with your feet on the ground. Do not change the display while driving.

- ▶ Press “OK” for less than three seconds: “ABS ON” starts blinking on the display.
- ▶ If you do not press any button, after three seconds the “ABS ON” selection is confirmed; under this condition, the ABS system is activated. Press “SET” to exit the “ABS” mode.





- ▶ Otherwise, by pressing “OK” while the caption is still blinking, “ABS OFF” appears on the display.
- ▶ If you do not press any button, after three seconds the “ABS OFF” selection is confirmed; under this condition, the ABS system is deactivated. Press “SET” to exit the “ABS” mode.

**WARNING**

When the ABS system is deactivated, the related warning light on the dashboard turns on (see § 3.7.1.). From this moment on, the anti-lock braking system is not available when braking. Adopt a cautious driving style and ride at low speed in order to avoid losing control of the vehicle during emergency brakings.





#### 4.4.7. "QUICK SHIFT" mode

► Press "SET" in order to access to "QUICK SHIFT" mode. The display shows the current activation state of the "quick shift" function of the gear change.



#### WARNING

The display modes may be changed or set when the engine is off, the gear in neutral, the motorbike stationary with your feet on the ground. Do not change the display while driving.

► Press the "OK" button for less than three seconds; the activation caption of the "quick shift" function begins to flash.

► By pressing the "OK" button for less than three seconds, the caption toggles from "OFF" to "ON" and inversely.

► Press "SET" to confirm the selected "quick shift" activation state.







#### 4.4.8. Clock settings

► To carry out clock settings, press the "SET" button until viewing the "CLOCK SETTING" caption.



#### WARNING

The display modes may be changed or set when the engine is off, the gear in neutral, the motorbike stationary with your feet on the ground. Do not change the display while driving.

- Press the "OK" button for less than three seconds; the hour digit begins to flash.
- By pressing the "OK" button again for less than three seconds, the hour digit is increased by going to the following numeric value.
- Press the "OK" button for over three seconds; the selected hour digit is confirmed. If instead one presses the "SET" button for less than three seconds the setting procedure is interrupted.

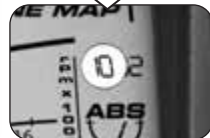
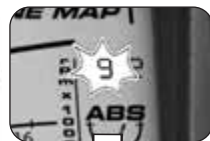



- ▶ After having carried out the hour digit setting, the dashboard automatically switches to the minute digit setting. The minute digit begins to flash.
- ▶ By pressing the "OK" button for less than three seconds, the minute digit is increased by going to the following numeric value.
- ▶ Press the "OK" button for over three seconds; the selected minute digit is confirmed and the dashboard returns to "CLOCK" mode. If instead one presses the "SET" button for less than three seconds the setting procedure is interrupted.

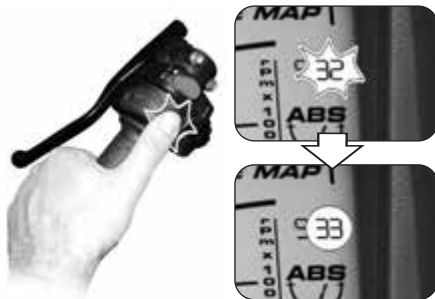



#### 4.4.9. “IMMOBILIZER” Mode

The “IMMOBILIZER” lets the engine start only if it recognises the original starter key. This is actually an anti-theft device built into the electronic circuit of the vehicle, since only authorised people are allowed to drive it.

Use the dashboard “IMMOBILIZER” only in the event of a breakdown. If for any reason the original key is not recognised by the system, to let the engine start you must manually enter the secret code, which is on the MV CodeCard that was handed out to you with the motorbike.

- ▶ Remove the lid from the box on the back of the MV Code Card and read the secret electronic code of the starter key (the figure shows a random code, for information only).
- ▶ Access to “RUN” mode and press “SET” for over ten seconds until “IMMOBILIZER” appears.



**WARNING**

The display modes may be changed or set when the engine is off, the gear in neutral, the motorbike stationary with your feet on the ground. Do not change the display while driving.

- ▶ Press “OK” for less than three seconds to set the first digit of the code.
- ▶ Press “OK” for less than three seconds to set the first digit between 0 and 9.
- ▶ Once the digit has been selected, press “OK” for over three seconds to confirm the first digit of the code. Now, you can set the second digit of the code.
- ▶ Do the same to set the other three digits of the code.





► Once the full code has been entered, “CONFIRM CODE” appears on the display. Press “OK” for over three seconds to confirm the code.



► If the entered code is recognised by the system, “VALID CODE” appears. The dashboard display goes back to “RUN”. The engine may be started.

► If the entered code is wrong, “NOT VALID CODE” appears. The system will not let the engine start; the display goes back to “IMMOBILIZER”. Repeat the code entry procedure from the start, taking care of setting all the right digits shown on your MV Code Card. If the problem persists, contact a MV Agusta licensed service centre.





#### 4.4.10. How to select the mapping of the control unit

On the Brutale model is it possible to select different control unit mappings which allow to obtain variable power and performance characteristics based on the type of vehicle use.

#### NOTE

The mapping selection may be performed even during the use of the vehicle.

The mapping of the control unit can be selected by pressing the button on the right side of the handlebar; this way the mapping switches to the following setting value. The corresponding mapping characteristics are listed in the following table.

Mapping	N	R	S	C
Mode	Normal	Rain	Sport	Customised



4 GB



### ❑ Setting of “Custom” mapping

- ▶ Press the “ENGINE MAP” button until selecting the mapping “C” of the control unit (“Custom” mapping).



#### WARNING

The “Custom” mapping setting operations must be performed when the gear is in neutral and the motorbike stationary with your feet on the ground. Do not change the display while driving.

- ▶ Press “SET” until “SETTING CUSTOM MAP” appears.

In order to adjust the “Custom” mapping parameters to your driving requirements, perform the following operations.

**NOTE:** The “Custom” mapping can be defined by mixing the Normal, Rain and Sport mapping characteristics when defining the following parameters.

- ▶ *Throttle control sensitivity:* Press “OK” for less than three seconds until “GAS SENSITIVITY” appears.





► Press “SET” for less than three seconds. The display shows the current setting for throttle control sensitivity.



► Press “OK” for less than three seconds; the displayed setting will start flashing.

► By repeatedly pressing “OK” for less than three seconds, the following settings can be displayed in sequence:

- “NORMAL”
- “RAIN”
- “SPORT”

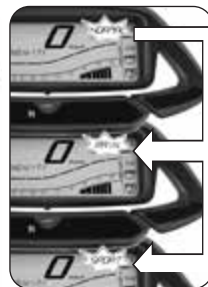





► Press “OK” for more than three seconds; the new setting will be confirmed. The displayed caption stops flashing and after a few seconds the display returns to “GAS SENSITIVITY” mode. It is now possible to proceed with the setting of the following parameter.



► *Maximum engine torque:* Press “OK” for less than three seconds until “MAX ENGINE TORQUE” appears.





► Press “SET” for less than three seconds. The display shows the current setting for maximum engine torque.

► Press “OK” for less than three seconds; the displayed setting will start flashing.

► By repeatedly pressing “OK” for less than three seconds, the following settings can be displayed in sequence:

- “RAIN”
- “SPORT”





► Press “OK” for more than three seconds; the new setting will be confirmed. The displayed caption stops flashing and after a few seconds the display returns to “MAX ENGINE TORQUE” mode.



► *Engine brake:* Press “OK” for less than three seconds until “ENGINE BRAKE” appears.





► Press “SET” for less than three seconds. The display shows the current setting for engine brake.



► Press “OK” for less than three seconds; the displayed setting will start flashing.

► By repeatedly pressing “OK” for less than three seconds, the following settings can be displayed in sequence:

- “NORMAL”
- “SPORT”





► Press “OK” for more than three seconds; the new setting will be confirmed. The displayed caption stops flashing and after a few seconds the display returns to “ENGINE BRAKE” mode.



► *Engine response:* Press “OK” for less than three seconds until “ENGINE RESPONSE” appears.





► Press “SET” for less than three seconds. The display shows the current setting for engine response.



► Press “OK” for less than three seconds; the displayed setting will start flashing.

► By repeatedly pressing “OK” for less than three seconds, the following settings can be displayed in sequence:

- “SLOW”
- “FAST”



4 GB



► Press “OK” for more than three seconds; the new setting will be confirmed. The displayed caption stops flashing and after a few seconds the display returns to “ENGINE RESPONSE” mode.



► *Engine RPM limiter:* Press “OK” for less than three seconds until “RPM LIMITER” appears.





► Press “SET” for less than three seconds. The display shows the current setting for engine RPM limiter.



► Press “OK” for less than three seconds; the displayed setting will start flashing.

► By repeatedly pressing “OK” for less than three seconds, the following settings can be displayed in sequence:

- “NORMAL”
- “SPORT”







► Press “OK” for more than three seconds; the new setting will be confirmed. The displayed caption stops flashing and after a few seconds the display returns to “RPM LIMITER” mode.



► Press “OK” for less than three seconds until the display switches to the “RUN” mode. The setting of the “Custom” mapping is completed.





#### 4.4.11. Warning/malfunction alerts

The dashboard may highlight the presence of a fault or a malfunction during different using conditions of the motorcycle.

► *Engine start:* As you turn the ignition switch to the ON position, the instruments and the warning lights will go through the self-diagnostic cycle. If the self-diagnostic cycle detects a fault in the vehicle, the display shows the warning alert shown in the picture. In particular, this message highlights the vehicle part or device on which the fault has been detected.

► Press “OK” button to access to “RUN” mode. The direction indicator emergency lights begin to flash.



#### WARNING

If a fault is detected on the vehicle when the engine is off, do not start engine and contact an authorized MV Agusta centre.



4 GB





► *Fault during vehicle riding:* If a fault is detected during riding, the lower portion of the display shows the warning alert shown in the picture. The direction indicator emergency lights begin to flash.

**WARNING**

If a fault is detected during riding, stop the vehicle and contact an authorized MV Agusta centre.



► After the vehicle is stopped, the display shows the warning message highlighting the vehicle part or device on which the fault has been detected.



► *High coolant temperature:* If a high value of the coolant temperature is detected, the display shows the warning alert shown in the picture. This message may appear during every using condition of the vehicle.

**WARNING**

If the coolant temperature is high, stop the motorbike and check the coolant level. If it needs to be filled up, contact a MV Agusta licensed service centre (see § 3.8). If the warning alert appears even if the level is adequate, stop driving and contact a MV Agusta licensed service centre





#### 4.5. Refuelling



##### WARNING

Petrol and its fumes are highly toxic and flammable. Avoid contact and inhalation. When refuelling, switch off the engine, avoid smoking, and keep away from flames, sparks and heat sources. Perform refuelling in the open air or in a well ventilated area.



Caution: Only use fuel having the following characteristics:

- Unleaded gasoline
- Ethanol content up to 10% volume
- R.O.N. octane rating of 95 or higher



The green dot under the fuel tank cap lip and the “E10” label on the fuel tank itself serve as reminders.



- ▶ Lift the dust cover.
- ▶ Insert the key into the lock and rotate it clockwise.





- ▶ Lift the tank cap and operate the refuelling.

**WARNING**

Overfilling the tank may cause the fuel to overflow as a result of the expansion due to the heat from the engine or to exposure to sunlight. Fuel spills can catch fire. The level of the fuel in the tank must never be higher than the base of the filler.

- ▶ After refuelling, press down the tank cap while rotating the key clockwise to facilitate the locking. Then release the key and remove it.

**CAUTION**

Immediately wipe the overflowed fuel with a clean cloth, to avoid damage to the painted or plastic surfaces.

**WARNING**

Verify that the tank filler cap is correctly closed before using the motorcycle.

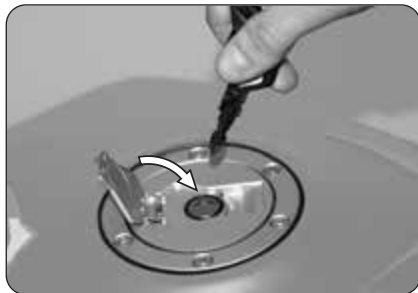



#### 4.6. Passenger saddle removal

- ▶ Insert the key into the lock.
- ▶ Rotate the key counterclockwise while slightly pushing the saddle. Lift the saddle and remove it as shown in the picture.

In order to reassemble the above mentioned part, you must perform the following operations:

- Rotate the key into the lock;
- Replace and hook the saddle;
- Press down the seat;
- Release the key;
- Press down the seat once more, so to make sure of its firm coupling to the frame.



#### WARNING

Every time you remove and refit the seat and every time the vehicle is used, make sure that the above mentioned part is correctly placed and that it is firmly secured to the motorcycle framework.

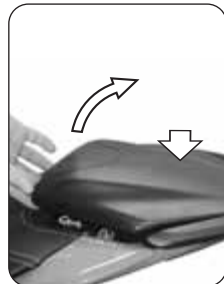
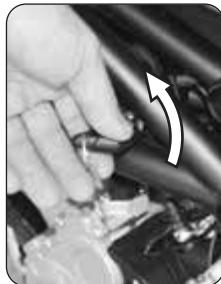



#### 4.7. Driver's saddle removal

- ▶ Remove the pillion as described in paragraph §4.6.
- ▶ Remove the two rear fixing screws and the related spacers with a 4 mm hexagonal screwdriver. Lift the saddle and remove it as shown in the picture.

In order to reassemble the above mentioned part, you must perform the following operations:

- Replace the saddle;
- Reassemble the two rear fixing screws with the related spacers;
- Reassemble the pillion as described in paragraph §4.6.



#### WARNING

Every time you remove and refit the seat and every time the vehicle is used, make sure that the above mentioned part is correctly placed and that it is firmly secured to the motorcycle framework.







#### 4.8. Parking the motorcycle

##### □ Using the sidestand



##### WARNING

Park the motorcycle safely on solid ground. On slopes, engage the first gear and park the vehicle so that the front wheel faces uphill. Remember to put the gear lever in the neutral position before restarting the engine. Never leave the vehicle unattended while the engine key is in the dashboard.



##### WARNING

Do not sit on the vehicle when it is parked on the sidestand, as your full weight would rest on the vehicle's only support. Before riding off, ensure that the sidestand warning light on the instrument panel goes out. In any case, make sure that the stand has been retracted. If you notice a malfunction of the side stand switch, have it controlled by your MV Agusta dealer before using the motorcycle.

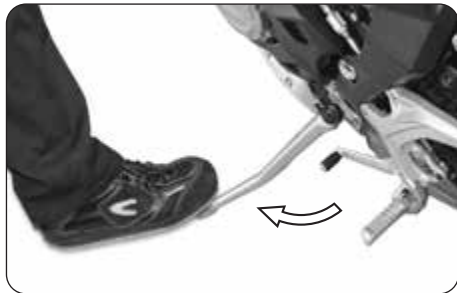

- ▶ Using your foot, lower the sidestand as far as it will go, and then slowly tip the motorcycle toward you to bring the stand supporting foot into contact with the ground's surface.



### □ Using the rear stand

Insert the stand pin into the rear wheel axle hole on the left side of the motorcycle. Rest the stand on the ground and, pressing down on the stand, lift the vehicle until it reaches a stable condition.



#### CAUTION

This operation is best carried out with two people.

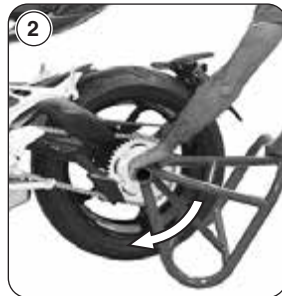



### 5.1. List of adjustments

There are many adjustments that can significantly improve the ergonomics, geometry and safety of the motorcycle.

However, since an incorrect adjustment of particularly important components can lead to dangerous situations, some of the above adjustments must be performed only by authorized MV Agusta Service Centers.



#### **WARNING**

**All adjustments must be performed when the vehicle is stationary.**



(F) Rearview mirror adjustment (§5.6.)

(H) Front suspension adjustment (§5.7.)

(A) Front brake lever  
adjustment (§5.3.)

(M) Headlight adjustment (§5.9.)

(D) Rear brake lever  
adjustment (§5.2.)





(F) Rearview mirror adjustment (§5.6.)

(E) Steering damper adjustment  
(Brutale RR) (§5.5.)

(B) Clutch lever adjustment  
(§5.4.)

(L) Rear suspension adjustment (§5.8.)

(C) Gear lever  
adjustment (§5.2.)

(G) Drive chain adjustment (§5.2.)

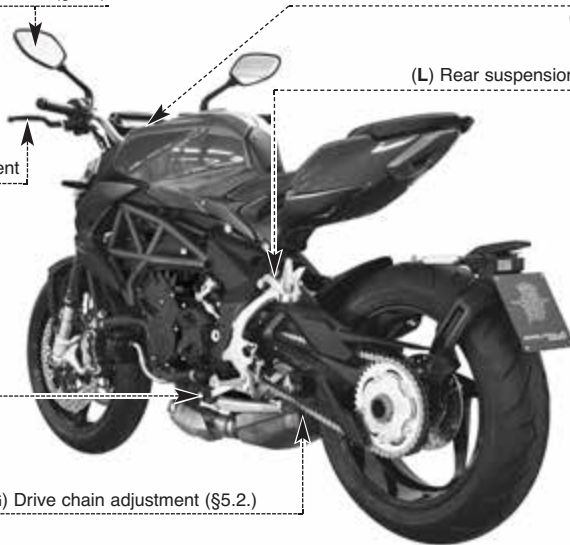



## 5.2. Table of adjustments

	<b>A - Front brake lever adjustment:</b> Optimizes the grip to suit the rider's needs (§5.3).		<b>G - Drive chain adjustment:</b> To ensure safe and effective transmission of power.
	<b>B - Clutch lever adjustment:</b> Optimizes the grip to suit the rider's needs (§5.4).		<b>H - Front suspension adjustment:</b> The following can be adjusted to adapt the response of the suspension to the rider's preference: <ul style="list-style-type: none"><li>- spring preload (§5.7.1.)</li><li>- rebound damper (§5.7.2.)</li><li>- compression damper (§5.7.3.)</li></ul>
	<b>C - Gear lever adjustment:</b> Optimizes the position of the lever to suit the rider's needs.		<b>L - Rear suspension adjustment:</b> The following can be adjusted to adapt the response of the suspension to the rider's preference: <ul style="list-style-type: none"><li>- geometry height</li><li>- spring preload</li><li>- rebound damper (§5.8.1.)</li><li>- compression damper (§5.8.2.)</li></ul>
	<b>D - Rear brake lever adjustment:</b> Optimizes the position of the lever to suit the rider's needs.		<b>M - Headlight adjustment:</b> To adjust the range of the light beam to the geometry of the motorcycle (§5.9).
	<b>E - Steering damper adjustment (Brutale RR):</b> Adjusts the steering stiffness to the rider's preference (§5.5).		
	<b>F - Rearview mirror adjustment:</b> Optimizes the orientation of the rearview mirrors (§5.6).		
	<b>WARNING: Do not operate the screw fixing the rearview mirror to the handlebar. If this screw needs to be tightened, contact your MV Agusta dealer.</b>		



### 5.3. Adjusting the front brake lever

Rotate the lever adjust to change its position. Clockwise: the lever moves closer to the handle. Counter-clockwise: the lever moves away from the handle.



### 5.4. Adjusting the clutch lever

Rotate the lever adjust to change its position. Clockwise: the lever moves closer to the handle. Counter-clockwise: the lever moves away from the handle.

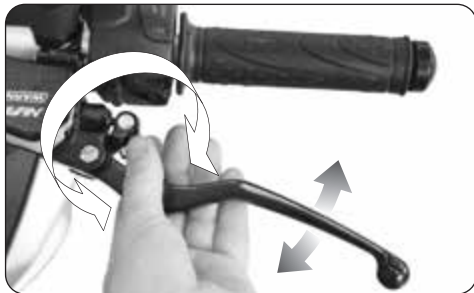



### 5.5. Adjusting the steering damper (Brutale RR)

The standard adjustment is obtained by fully rotating the knob counterclockwise. In this position the damper offers the least resistance to the rotation of the steering.

To suit the rider's needs, the action of the damper can be gradually increased by rotating the knob clockwise.

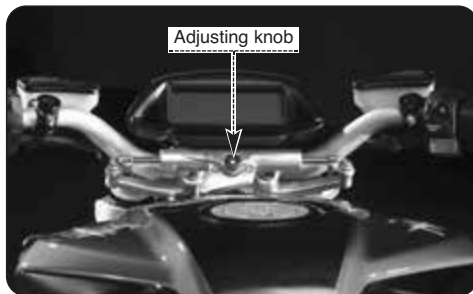





## 5.6. Adjusting the rearview mirrors

Rotate the rearview mirror body to adjust its position in the four directions.

Perform the adjustment on both rearview mirrors. It is recommended to sit on the vehicle in order to optimize the rearview mirrors adjustment.



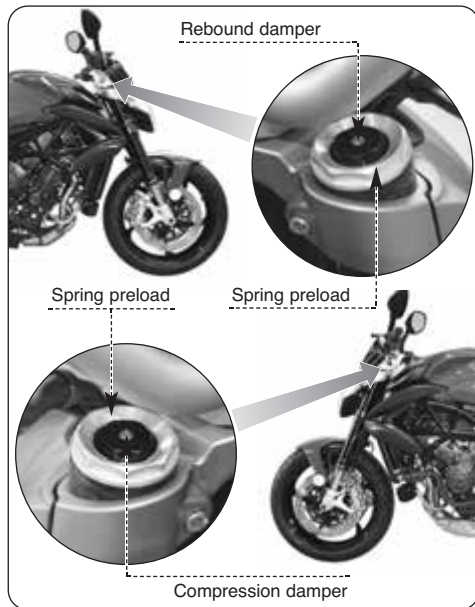

## 5.7. Adjusting the front suspension

**NOTE:** The adjustment of the suspensions must be preferably performed with the fuel tank full.

### 5.7.1. Spring preload (front suspension)

The adjustment is obtained from the reference position, which is found by fully turning the adjusting nut counterclockwise; from this position, turn the screw clockwise until you reach the standard position (see enclosed table). Rotate clockwise to increase the spring preload or counterclockwise to decrease it.





### 5.7.2. Rebound damper (front suspension)

The adjustment is obtained from the reference position, which is found by fully turning the screw clockwise and then counterclockwise until you reach the standard position (see enclosed table). Rotate clockwise to increase the damping action or counterclockwise to decrease it.

### 5.7.3. Compression damper (front suspension)

The adjustment is obtained from the reference position, which is found by fully turning the screw clockwise and then counterclockwise until you reach the standard position (see enclosed table). Rotate clockwise to increase the damping action or counterclockwise to decrease it.





### 5.8. Adjusting the rear suspension



#### WARNING

The rear shock absorber contains highly compressed gas. Do not try to open or disassemble it in any way.

**NOTE:** The adjustment of the suspensions must be preferably performed with the fuel tank full.

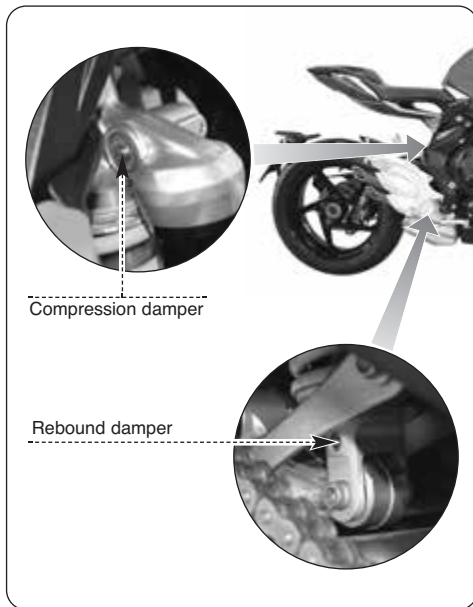

Compression damper

Rebound damper



### 5.8.1. Rebound damper (rear suspension)

The adjustment is obtained from the reference position, which is found by fully turning the screw clockwise and then counterclockwise until you reach the standard position (see enclosed table). Rotate clockwise to increase the damping action or counterclockwise to decrease it.

### 5.8.2. Compression damper (rear suspension)

The adjustment is obtained from the reference position, which is found by fully turning the screw clockwise and then counterclockwise until you reach the standard position (see enclosed table). Rotate clockwise to increase the damping action or counterclockwise to decrease it.





### 5.9. Headlight adjustment

Place the vehicle at a distance of 10 m from a vertical wall. Make sure that the motorcycle is placed on an even horizontal surface, and that the headlight's optical axis is perpendicular to the wall.

The vehicle must be held in an upright position. Measure the "X" distance between the headlight center and the ground surface, then trace a small cross on the wall at the same height.

When you turn the headlight on, the upper boundary line between the dark area and the lighted area must be at an height equal or lower than the 9/10 of the headlight center height (X).

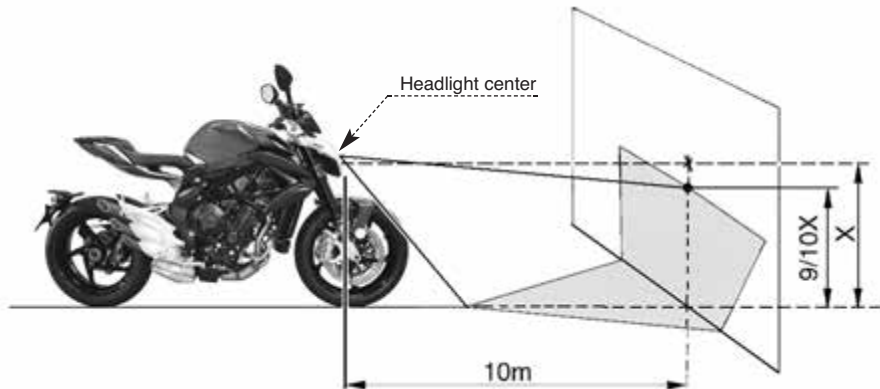



The headlight adjustment can be performed by rotating the screw shown in the picture. Rotate clockwise to incline the headlight downwards, counterclockwise to incline it upwards. It can be tilted up to an angle of  $\pm 4^\circ$  from the standard position.

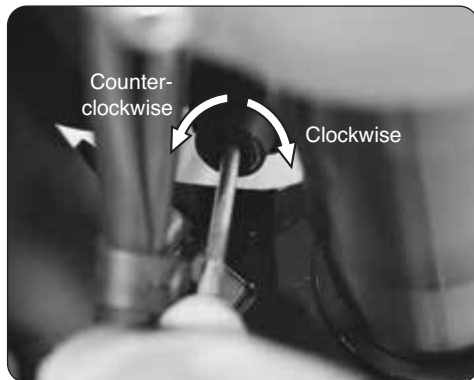



### Information

MV Agusta Motor S.p.A. is committed to a policy of constant improvement; therefore, you may find slight differences between the information provided in this document and the vehicle you purchased. MV Agusta motorcycles are exported in several countries, in which different rules and regulations (concerning both the Highway Code and the homologation procedures) are in force. Relying on your understanding, MV Agusta Motor S.p.A. deems it necessary to reserve the right to change its products and the related documentation at any time and without notice.

We suggest to often visit the Internet site [www.mvagusta.it](http://www.mvagusta.it) in order to obtain informations and updates about the MV Agusta products and the related documentation.



### Respect and defend natural environment

Everything we do affects the whole planet as well as its resources.

MV Agusta, in order to protect the interests of the community, awakens the Customers and the Technical Assistance operators to use the vehicle and dispose of its replaced parts respecting the laws in force concerning environmental pollution and waste disposal and recycling.

© 2017

This document may not, in whole or in part, be reproduced without prior consent, in writing, from MV Agusta Motor S.p.A.

Part No. 8000C5107

Edition No. 1 - November 2017





## NOTES

GB 5

A series of horizontal dotted lines for writing notes.

**BRUTALE  
6000-RR**

**MV AGUSTA**



Manuel d'utilisation  
*Version Française*

*Cher client,*

*Nous vous remercions de la confiance que vous nous accordez et vous félicitons pour votre nouvelle Brutale.*

*Grâce à la passion et aux efforts de ses techniciens, MV Agusta présente aujourd'hui aux amateurs un produit à l'esthétique inédite associée à une partie cycle raffinée. Ces éléments, qui ont caractérisé toutes les créations de la maison MV Agusta tout au long de sa glorieuse histoire.*

*Le résultat est une moto exclusive qui se place, de par ses caractéristiques esthétiques et fonctionnelles et de par ses innombrables innovations techniques, au plus haut niveau que le marché motocycliste puisse offrir à l'heure actuelle.*

*Les solutions qui ont été mises en place confère à la Brutale ce caractère unique qui la rapproche des autres modèles de la famille MV Agusta tout en consolidant une philosophie de conception qui privilégie un effort constant de recherche, l'innovation technologique et l'amour pour le détail, et en donnant la possibilité à tous ceux qui vivent leur passion pour la moto en pleine liberté de posséder un objet unique au monde qui s'impose avec fermeté sur la place mondiale.*

*Si vous désirez plus d'information, n'hésitez pas à contacter notre Service Après-Vente MV Agusta.*

*Bon divertissement!*

*Giovanni Castiglioni  
Président  
MV Agusta*



## TABLE DES MATIÈRES

<i>Chap.</i>	<i>Sujets abordés</i>	<i>page</i>
<b>1</b>	<b>GÉNÉRALITÉS</b>	<b>5</b>
1.1.	Utilité de ce livret	5
1.2.	Symboles	6
1.3.	Certificat de livraison	7
1.4.	Données d'identification	8
<b>2</b>	<b>INFORMATIONS SUR LA SÉCURITÉ</b>	<b>11</b>
2.1.	Garantie du véhicule	11
2.2.	Entretien programmé	12
2.3.	Chargement du véhicule	14
<b>3</b>	<b>COMMANDES ET APPAREILS</b>	<b>15</b>
3.1.	Position des commandes et appareils	15
3.2.	Béquille latérale	17
3.3.	Commandes au guidon côté gauche	18
3.4.	Commandes au guidon côté droit	20
3.5.	Contacteur principal et verrouillage de direction	23
3.6.	Sélecteur de vitesses	26
3.7.	Appareils et voyants	27
3.7.1.	Voyants lumineux	28
3.7.2.	Écran multifonctions	29
3.8.	Tableau des lubrifiants et liquides	30

<i>Chap.</i>	<i>Sujets abordés</i>	<i>page</i>
<b>4</b>	<b>UTILISATION</b>	<b>31</b>
4.1.	Utilisation de la moto	31
4.2.	Rodage	32
4.3.	Démarrage	34
4.4.	Sélection et modification des fonctions d'affichage	37
4.4.1.	Sélection des fonctions d'affichage	38
4.4.2.	Mise à zéro des fonctions des compteurs	43
4.4.3.	Modalité "SPEED LIMITER"	45
4.4.4.	Modalité TC	47
4.4.5.	Chronomètre	48
4.4.6.	Sélection des fonctions ABS	57
4.4.7.	Modalité "QUICK SHIFT"	59
4.4.8.	Configuration de l'horloge	60
4.4.9.	Modalité "IMMOBILIZER"	62
4.4.10.	Sélection représentation de la centrale	65
4.4.11.	Messages d'avertissement/pannes	77
4.5.	Approvisionnement en carburant	80
4.6.	Dépose de la selle passager	82
4.7.	Dépose de la selle pilote	83
4.8.	Stationnement de la moto	84



## TABLE DES MATIÈRES

<i>Chap.</i>	<i>Sujets abordés</i>	<i>page</i>
<b>5</b>	<b>RÉGLAGES</b>	<b>86</b>
5.1.	Liste des réglages	86
5.2.	Tableau des réglages	89
5.3.	Réglage du levier de frein avant	90
5.4.	Réglage du levier de l'embrayage	90
5.5.	Réglage de l'amortisseur de direction (Brutale RR)	91
5.6.	Réglage des rétroviseurs	92
5.7.	Réglage de la suspension avant	93
5.7.1.	Précharge du ressort (suspension avant)	93
5.7.2.	Dispositif hydraulique de freinage en détente (suspension avant)	94
5.7.3.	Dispositif hydraulique de freinage en compression (suspension avant)	94
5.8.	Réglage de la suspension arrière	95
5.8.1.	Dispositif hydraulique de freinage en détente (suspension arrière)	96
5.8.2.	Dispositif hydraulique de freinage en compression (suspension arrière)	96
5.9.	Réglage du projecteur avant	97



## 1.1. Utilité de ce livret

Ce Manuel fournit les informations nécessaires pour une utilisation correcte et sûre de la moto.

Ce Manuel est fourni aussi sous format électronique (.pdf) sur le support digital attachée (clé USB) et peut être imprimé ou affiché sur tout PC avec système Windows ou Mac.

Nous vous recommandons de lire attentivement le Manuel avant d'utiliser la moto et de vous assurer que toutes les personnes utilisant la moto ont lu attentivement le Manuel.

Sur le support numérique joint à la moto vous trouverez, en plus de ce manuel, le Manuel d'Entretien, le Guide des Concessionnaires et le Livret de Garantie.



Copyright  
MV AGUSTA Motor Spa  
Tous droits réservés



## 1.2. Symboles

Les parties du texte particulièrement importantes qui concernent la sécurité de la personne et l'intégrité de la moto, sont mises en évidences par les pictogrammes suivants:



**Danger - Attention: le non respect partiel ou total de ces prescriptions pourrait être source de danger pour soi-même et pour autrui.**



**Prudence - Précautions: le non respect partiel ou total de ces prescriptions pourrait être cause de dommages pour la moto.**

Pour indiquer les personnes autorisées à exécuter les opérations de réglage et/ou d'entretien, celles-ci sont mises en évidences par les pictogrammes suivants:



**Informations sur les opérations permises au motard.**



**Informations sur les opérations qui doivent être effectuées uniquement par le personnel autorisé.**

Pour mettre en évidence les informations supplémentaires, les symboles suivants sont utilisés:



**Le symbole  indique la nécessité d'utiliser un outil ou un appareil spécial pour l'exécution correcte de l'opération décrite.**



**Le symbole "§" renvoie au chapitre correspondant au numéro qui l'accompagne.**



## 1.3. Certificat de livraison

Au moment de vous remettre la moto, votre Concessionnaire vous a remis le Certificat de Garantie et de Préparation à la route.

Nous vous invitons à conserver le Certificat avec les documents de la moto et les coupons ou les factures qui vous seront remis à toutes les opérations de révision prévues par la garantie.

### **IMPORTANT**

Les copies du Certificat de Garantie et de Préparation à la route doivent être remplies par le Concessionnaire. Une copie doit être remise au Client, une copie doit être conservée par le Concessionnaire et la troisième doit être envoyée à l'Importateur.

La copie des coupons d'entretien programmé doit être toujours remplie par le concessionnaire. Elle doit être conservée par le Client.





FR 1



## 1.4. Données d'identification

- 1) numéro de série du cadre
- 2) numéro de série du moteur
- 3) données d'homologation

### ► Identification de la moto

La moto est identifiable grâce au numéro de série du cadre. Pour les commandes de pièces détachées, il pourrait être nécessaire d'indiquer également le numéro de série du moteur, le code couleur et le numéro d'identification des clés.

Il est conseillé de noter les données principales dans les espaces ci-dessous:

**CADRE N.:** \_\_\_\_\_

**MOTEUR N.:** \_\_\_\_\_



## ► Identification des clés de la moto

Une clé est fournie en double exemplaire, elle sert pour le contacteur de démarrage et pour toutes les autres serrures. Garder le double en lieu sûr.

Il est indispensable de connaître le numéro d'identification de la clé pour en demander un double. Le numéro d'identification de la clé est imprimé sur la MV Code Card fournie avec les clés de démarrage.



1  
FR

## ► Identification de la combinaison des couleurs de la moto

Le code couleur est indispensable pour la commande de pièces détachées de la carrosserie. On peut lire ce code sur la plaque qui se trouve sur la partie inférieure arrière du réservoir d'essence.

Pour accéder à la plaque du code couleur, il faut enlever la selle passager et la selle pilote en suivant les indications des paragraphes §4.6. et §4.7.





FR 1

Après avoir enlevé les selles, on peut lire la plaque du code couleur. Cette plaque porte la mention du code couleur de la moto qui détermine la couleur des parties de la carrosserie.

Il est conseillé de noter le numéro d'identification du code couleur de la moto dans l'espace suivant:

**CODE COULEUR:** .....

Pour obtenir les couleurs de référence des parties peintes en fonction du code couleur de la moto, reportez-vous au Manuel d'Entretien inclus sur le support digital fournis.

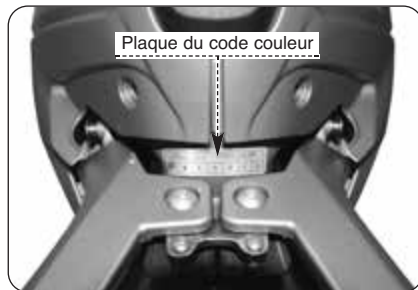



## 2.1. GARANTIE DU VÉHICULE



### ATTENTION

Nous vous rappelons que la garantie ne couvre pas l'utilisation du véhicule en compétition moto, ni sur piste ni sur route. En effet, il s'agit d'un usage non prévu, incompatible avec l'utilisation sur route pour laquelle votre véhicule a été spécifiquement étudié.

La garantie ne couvre pas non plus l'utilisation professionnelle, notamment et à titre non exhaustif, taxi, location, etc.

Nous vous rappelons également que MV Agusta se réserve d'étudier le droit à la garantie dans tous les cas, sans aucune exception, où le véhicule a été modifié par rapport à sa configuration d'origine, même avec des pièces détachées ou des accessoires d'origine MV Agusta montés par le service après-vente d'un concessionnaire MV Agusta.

La garantie ne s'applique pas non plus si les interventions d'entretien programmé et les autres interventions de réparation, réglage, remplacement de pièce, etc. sont réalisées par un atelier, un technicien, un service après-vente ou un tiers quel qu'il soit qui ne respecte pas les standards techniques et les procédures que MV met à la disposition du personnel technique qualifié et formé à l'entretien du véhicule (cours techniques, outillage spécifique d'atelier, manuels, pièces détachées d'origine, etc.) ou qui n'utilise pas les pièces détachées et les accessoires d'origine MV Agusta.

Dans tous les cas, nous précisons que la garantie ne couvre pas les pièces d'usure ni les consommables (lubrifiants, liquides, bougies, embrayage, filtres, chaîne, couronne, pignon, plaquettes de frein, disques de freins,



pneus, tubes et pièces en caoutchouc, batterie, lampes et fusibles) ni les événements causés par la négligence, l'imprudence ou l'exposition aux agents atmosphériques (défaut de la peinture, corrosion, etc.) ou par le dépassement des limites de chargement prévues par le Manuel d'utilisation du véhicule.

Nous vous rappelons que conformément à la loi, cette garantie est gérée directement par votre concessionnaire MV Agusta que nous vous invitons à contacter si nécessaire en cas de besoin. Elle est valable également à l'étranger, auprès de tout concessionnaire du réseau MV agusta.

## 2.2. ENTRETIEN PROGRAMMÉ



### ATTENTION

Nous vous signalons que si votre véhicule présente des dommages ou des dysfonctionnements consécutifs au non respect du calendrier d'entretien, votre concessionnaire peut vous refuser le bénéfice de la garantie. En outre, dans ce cas, votre concessionnaire et MV Agusta S.p.A. déclinent toute responsabilité pour les dommages subis par le véhicule, l'utilisateur, les tiers et les biens appartenant à des tiers suite à ces dommages et dysfonctionnements.

Les opérations d'entretien programmé, y compris les premières, sont payantes, pièces et main d'œuvre.

MV Agusta vous rappelle que toutes les interventions sur le véhicule, entretien programmé, réparations, réglages, remplacement de pièces, etc.,



doivent être exécutées par un atelier agréé, chez un concessionnaire MV Agusta, conformément aux modalités exposées dans le Manuel d'entretien, le Manuel d'atelier et les Circulaires techniques publiées par MV Agusta S.p.A. MV Agusta ne garantit l'intervention que si elle est effectuée dans un atelier agréé, chez un concessionnaire MV Agusta opérant conformément aux standards techniques et aux procédures MV Agusta, en utilisant exclusivement des pièces détachées et des accessoires d'origine.

Après chaque opération d'entretien programmé, vérifiez toujours que le coupon est tamponné et signé par le concessionnaire et que l'intervention répond à vos attentes. Ces coupons se trouvent à la fin du Livret de garantie.

Conservez toujours le Livret de garantie qui contient les coupons d'entretien programmé tamponnés par le concessionnaire MV Agusta et les factures correspondantes que vous remettrez au nouvel acquéreur en cas de cession du véhicule.

### Calendrier d'entretien programmé

Fréquence d'entretien Km (mi)*	1000 (600)	Tous les ans	15000 (9000)	30000 (18000)	45000 (27000)	60000 (36000)	75000 (45000)	90000 (54000)	105000 (63000)
Révision	A		B	C	D	E	F	G	H

(\*): Les coupons de kilométrage peuvent être effectués avec le coupon annuel **obligatoire**



### 2.3. CHARGEMENT DU VÉHICULE

Le véhicule a été conçu pour être utilisé par un pilote et le cas échéant un passager.

Pour l'utiliser en toute sécurité et dans le respect des dispositions du code de la route, il est obligatoire de ne jamais dépasser le poids lourd total maximum admis dont le valeur est indiquée ci-dessous.

#### **BRUTALE 800 - RR**

Masse maximum techniquement admissible

**379 kg**

Masse maximum transportable

**180 kg**

La masse maximum techniquement admissible est la somme des masses suivantes:

- masse de la moto;
- masse du pilote;
- masse du passager;
- masse du bagage et des accessoires.



#### **ATTENTION**

Etant donné que le chargement a un impact énorme sur la maniabilité, le freinage, les performances et les caractéristiques de sécurité de votre moyen de transport, prenez toujours les précautions suivantes.

- **NE SURCHARGEZ JAMAIS LE MOTOCYCLE!** L'utilisation d'une moto surchargée peut provoquer des dégâts aux pneumatiques, des pertes de contrôle ou des accidents graves. Vérifiez que le poids total du pilote, du passager, du chargement et des accessoires ne dépasse pas la masse maximum admissible spécifique à votre véhicule.



## 3.1. Position des commandes et appareils

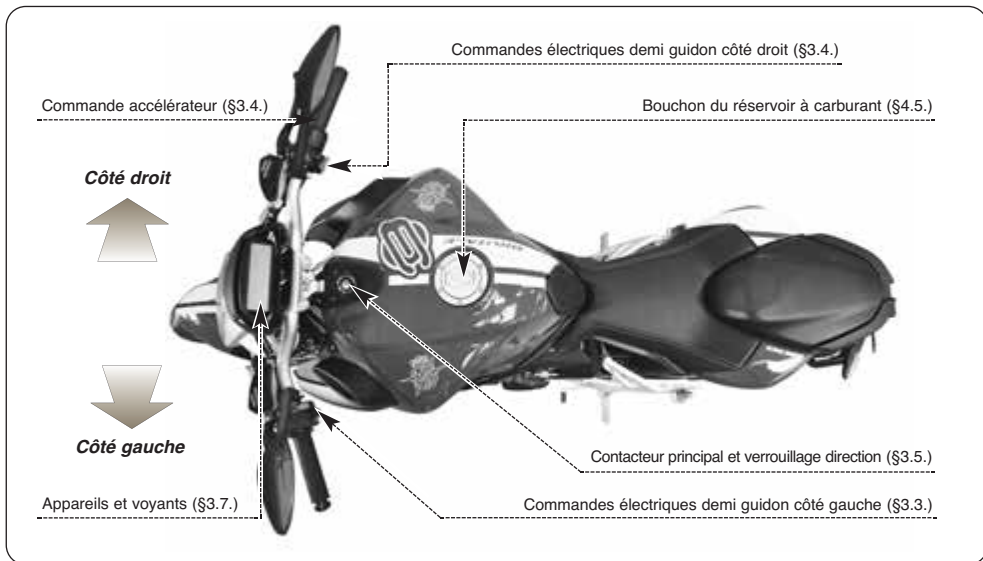





FR 3

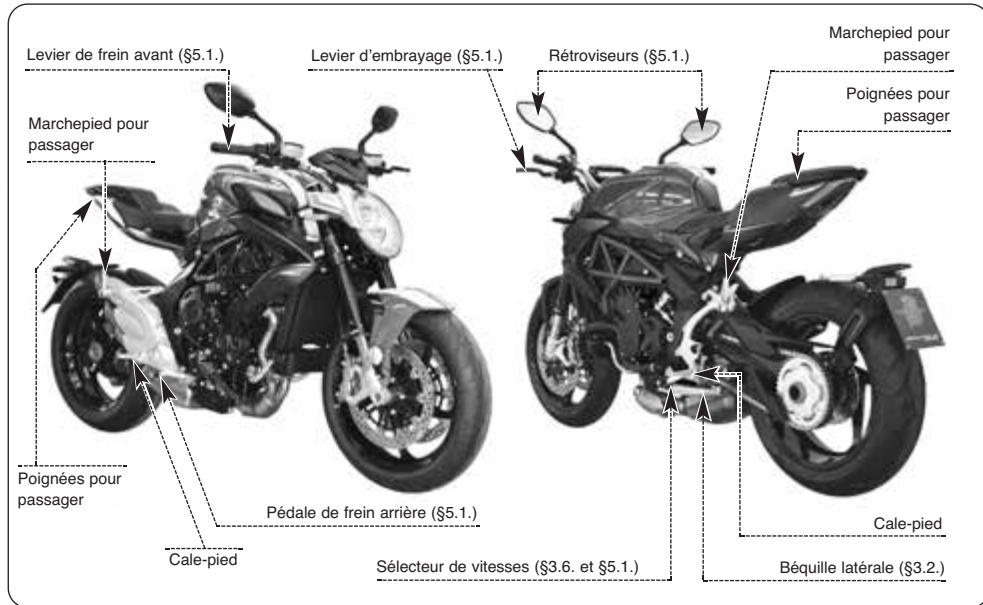



### 3.2. Béquille latérale

La béquille latérale est équipée d'un contacteur qui empêche à la moto de démarrer avec la béquille baissée.

Si le sélecteur de vitesses est actionné pour mettre la moto en mouvement lorsque le moteur tourne avec la béquille abaissée, le contacteur coupe le courant au moteur et provoque son arrêt.

Dans le cas où la moto se trouve en condition de stationnement (béquille baissée) avec un rapport engagé, le contacteur empêche le démarrage du moteur pour éviter tout risque de chute accidentelle.

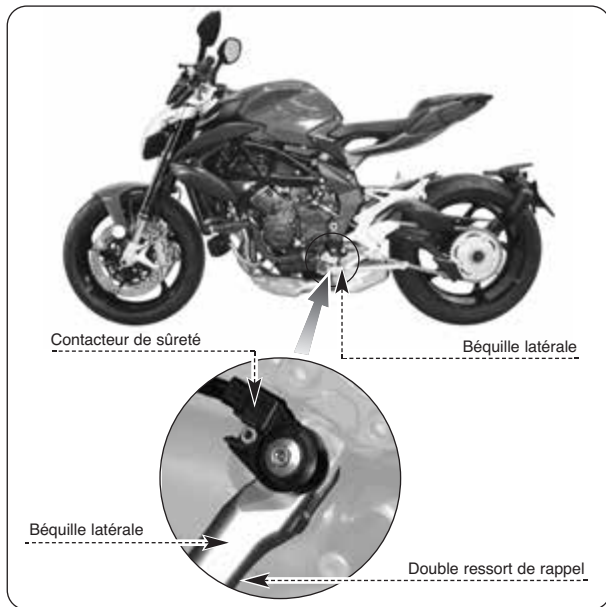

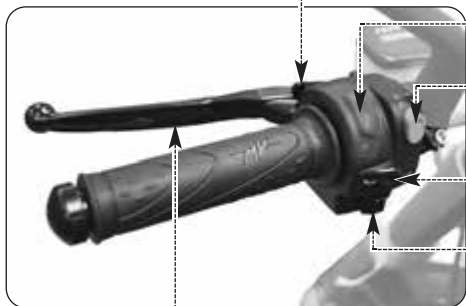

## 3.3. Commandes au guidon côté gauche

**Bouton de clignotement des phares**

Appuyer sur le bouton à répétition.

**Bouton SET/OK**

Appuyer pour modifier les fonctions du tableau de bord (§4.4).

**Inverseur code/phare**

Bouton sorti ■ : feu de croisement 

Bouton enfoncé ▬ : feu de route 

**Bouton de l'avertisseur sonore**

Appuyer pour utiliser l'avertisseur.

**Poussoir de clignotants**

En le déplaçant vers la droite ou la gauche on allume les clignotants correspondants. Le poussoir revient au centre, appuyer dessus pour éteindre les clignotants.

**Levier d'embrayage**

Tirer ou relâcher la poignée pour débrayer ou embrayer.



### Bouton d'appel de phare

Cette fonction sert pour rappeler l'attention des autres usagers de la route en présence d'une situation dangereuse. Avec le feu de route éclairé, cette fonction est désactivée.

### Bouton SET/OK

Le bouton SET permet de sélectionner les fonctions de l'écran pour réaliser les réglages. Le bouton OK sert à valider les valeurs sélectionnées.

### Bouton Inverseur code/phare

C'est normalement la fonction code qui s'allume. Lorsque les de trafic et de route le permettent, il est possible d'allumer le feu de route en agissant sur l'inverseur.

### Levier des clignotants

Cette fonction permet de signaler aux autres usagers de la route, l'intention de changer de direction ou de voie de circulation.



#### ATTENTION

**Si les clignotants ne sont pas utilisés ou coupés au moment opportun, il peut y avoir un risque d'accidents. En effet, les autres conducteurs pourraient tirer des conclusions erronées concernant la trajectoire du véhicule. Actionnez toujours les clignotants avant de tourner ou de changer de voie. Veillez à les couper dès que la manoeuvre est terminée.**

### Bouton de klaxon

Cette fonction sert pour attirer l'attention des autres usagers en cas de situations éventuelles de danger.

### Levier d'embrayage

Ce levier permet de débrayer et d'embrayer.



### 3.4. Commandes au guidon côté droit

#### **Bouton feux de détresse**

Appuyer pour allumer et éteindre les feux de détresse.

#### **Bouton "Engine Map"**

Appuyer pour sélectionner le mappage du moteur (§4.4.10.).

#### **Coupe-circuit**

Coupe le moteur et empêche le démarrage.

#### **Bouton du démarreur**

Actionne le démarreur. Dès que le moteur part, il faut le relâcher.

#### **Commande d'accélérateur**

Tourner pour régler l'alimentation du moteur.

#### **Levier feux de nuit/feux de jour (DRL) \***

Pour allumer les feux de nuit (feux de route/feux de croisement) ou les feux de position de jour (Day Running Lights), déplacer le levier vers le haut ou vers le bas.

#### **Levier de frein avant**

Tirer vers la poignée pour actionner le frein avant.

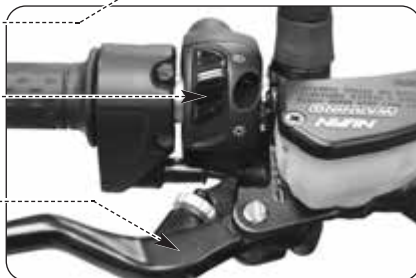
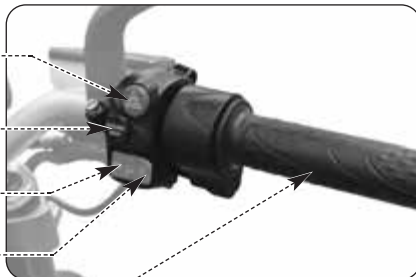

(\*): Fonction non présente sur les versions Japon et Australie



### Bouton feux de détresse

Cette fonction sert pour rappeler l'attention des autres usagers de la route en présence d'une situation dangereuse.

### Bouton "Engine Map"

Ce bouton définit automatiquement le mappage du moteur (voir §4.4.10).

### Coupe-circuit moteur

Cette fonction permet d'éteindre le moteur. De cette manière, le circuit d'allumage est coupé empêchant le redémarrage du moteur. Pour pouvoir démarrer, ramener le bouton en position de repos.

**NOTE: En conditions normales, utilisez ce dispositif pour couper le moteur.**

### Bouton de démarrage moteur

Ce dispositif permet le démarrage du moteur. De plus, une fois le moteur démarré, il permet de sélectionner les fonctions de l'affichage du tableau de bord.



**RAPPEL: Pour éviter des dommages à l'installation électrique, ne tenez pas le bouton enfoncé plus de 5 secondes consécutives. Si le moteur ne démarre après plusieurs tentatives, consultez le chapitre "PANNES" du "Manuel d'entretien".**

### Commande d'accélérateur

Ce dispositif permet d'agir sur l'alimentation du moteur pour varier son régime de rotation. Pour actionner le dispositif, il faut faire pivoter la poignée à partir de la position de repos qui correspond au régime de ralenti moteur.



**ATTENTION: Dans le cas où Votre moto est tombée ou a été impliquée dans un accident, faites vérifier le fonctionnement de l'accélérateur par un centre de service autorisé MV Agusta avant de reprendre la marche.**



### Levier feux de nuit/feux de jour (DRL) \*

Il permet d'activer alternativement les feux de jour (Day Running Lights) et les feux de nuit (feux de route/feux de croisement - voir § 3.3) selon les conditions extérieures.

### Levier frein avant

Cette commande provoque l'actionnement par l'intermédiaire d'un circuit hydraulique du système de freinage de la roue avant.

### ☐ Système anti-blocage de frein (ABS)

Les modèles Brutale sont équipés d'un système d'assistance au freinage ABS ("Antilock Braking System"), ce qui empêche les roues de se bloquer pendant le freinage d'urgence, ce qui garantit la stabilité du véhicule et le raccourcissement de la distance de freinage.



**ATTENTION:** Lorsque le système ABS est activé, des vibrations pourraient être perceptible sur le levier ou la pédale de frein. Dans ce cas, il est recommandé de maintenir enfoncé les dispositifs de commande des freins afin de permettre au véhicule de compléter le freinage.



**ATTENTION:** Si le système ABS est en panne ou est désactivé, le voyant correspondante sur le tableau de bord s'allume (voir § 3.7.1.). A partir de ce moment, le système antiblocage des freins ne pourraient pas être disponible lors du freinage. S'il ya un défaut dans le système ABS, il est recommandé de reprendre la course à vitesse réduite et contacter un centre d'assistance autorisé MV Agusta. Si le système ABS est désactivé, suivre la procédure d'activation décrite au § 4.4.6.

(\*): Fonction non présente sur les versions Japon et Australie



## 3.5. Contacteur principal et verrouillage de direction



**ATTENTION:** Ne pas appliquer de porte-clés ou autre à la clé de contact pour ne pas risquer de gêner la rotation de la direction.



**ATTENTION:** Ne jamais chercher à changer certaines fonctions du contacteur en cours de route sous peine de perdre le contrôle du véhicule.

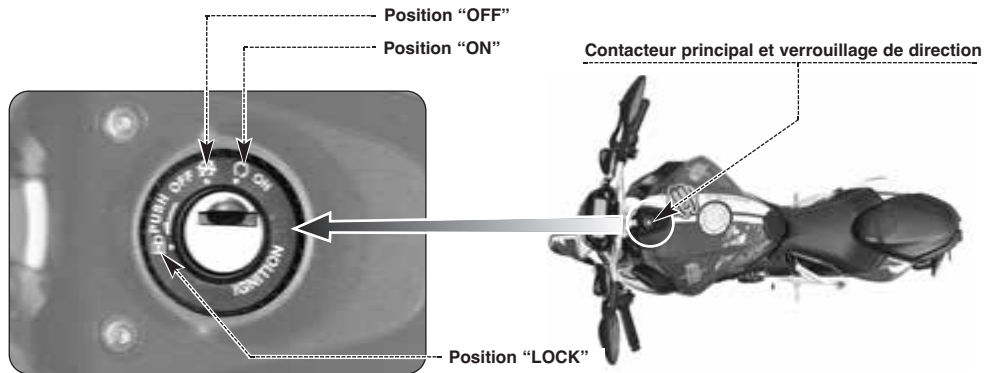





Le contacteur à clé branche et coupe le circuit électrique et le verrouillage de la direction; les quatre positions de commande sont décrites à la suite.

### Position “OFF”

Tous les circuits électriques sont coupés. La clé peut être retirée.



### Position “ON”

Tous les circuits électriques sont branchés, les appareils et les voyants effectuent l'auto-diagnostic; le moteur peut démarrer. La clé peut être retirée.



**Rappel-Précautions:** Ne pas laisser la clé sur la position “ON” à moteur éteint pendant trop longtemps sous peine d'endommager les composants électriques de la moto.



## Position "LOCK"

Braquer le guidon à droite ou à gauche. Pousser légèrement sur la clé et la tourner simultanément en position "LOCK".

Tous les circuits sont coupés et la direction est verrouillée. La clé peut être retirée.

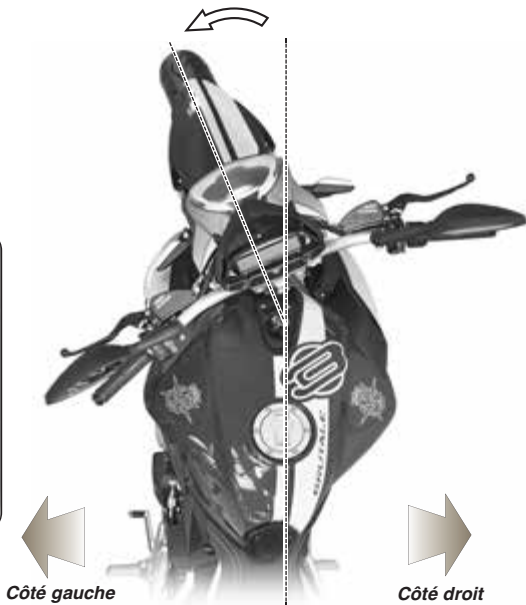

3 FR



### 3.6. Sélecteur de vitesses

La position **N** "Neutral" correspond au point mort signalé par le voyant correspondant sur le tableau de bord. En déplaçant le sélecteur vers le bas, on engage la première vitesse. De la même manière, en déplaçant le sélecteur vers le haut, on passe la seconde vitesse et ainsi de suite à mesure que l'on déplace le sélecteur vers le haut, on passe dans l'ordre toutes les vitesses suivantes jusqu'à la sixième.



#### ☐ Fonction "Quick Shift"

Les modèles Brutale sont équipés d'un système de changement rapide de vitesse ("Quick Shift"); cet appareil permet de enclencher le rapport supérieur ou inférieur sans tirer l'embrayage ou changer l'angle de la commande des gaz. De cette façon, il est possible de engager les vitesses supérieures ou inférieures en gardant une accélération constante et de réduire les temps de changement au minimum.



**ATTENTION: Le système "Quick Shift" n'est pas disponible dans les conditions suivantes:**

- lors du changement de vitesse avec le levier d'embrayage enfoncée;
- lorsque le véhicule se déplace à une vitesse inférieure à 30 km/h;
- lorsque le sélecteur n'est pas à la bonne position de départ pour un changement de vitesse.

En outre, lorsque vous conduisez le véhicule avec le moteur à un régime élevé et une basse vitesse, changer de vitesse sans tirer sur le levier d'embrayage peut provoquer des réactions brusques ce qui peut compromettre la stabilité du véhicule. MV Agusta recommande de tirer le levier d'embrayage dans toutes les circonstances ci-dessus, en particulier lorsque le régime moteur est proche de la vitesse de l'intervention du limiteur.



## 3.7. Appareils et voyants

Les appareils et les voyants sont activés lorsque la clé de contact est mise sur "ON". Après un check-up initial (~7 secondes), les informations correspondent aux conditions générales de la moto à ce moment là.

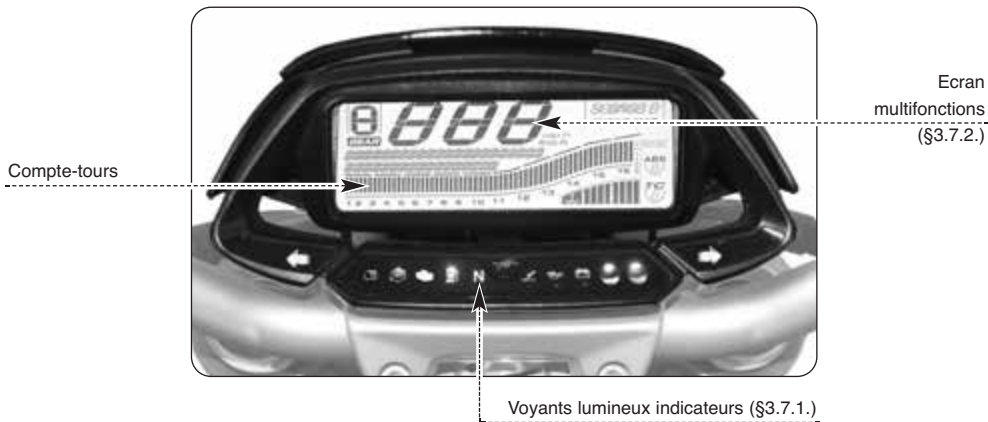



### 3.7.1. Voyants lumineux

#### Voyant ABS (rouge)

S'allume lorsque le système ABS est en panne ou est désactivé ou la vitesse est inférieure à 5 km/h.

**! Danger - Attention:** Si il s'allume pendant la marche, s'arrêter immédiatement et vérifier que le système ABS est activé (voir §4.4.6.). Dans ce cas, reprendre la course à vitesse réduite et contacter un centre d'assistance autorisé MV Agusta.

#### Voyant Feu de route (bleu)

S'allume quand le feu de route est allumé.

#### Voyant moteur (jaune)

Il s'allume pour signaler un dysfonctionnement du moteur.

#### Voyant Réserve carburant (orange)

S'allume quand le réservoir ne contient plus que 4 litres de carburant environ.

#### Voyant Levier de vitesses au point mort (vert)

S'allume quand le levier est en position de point mort "Neutral".

#### Voyant d'ouverture de la béquille latérale (rouge)

Il s'allume lorsque la béquille est baissée.

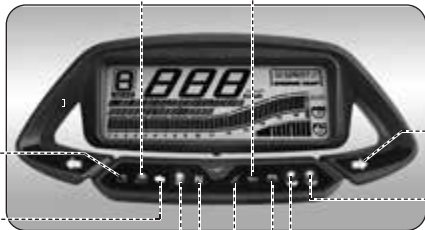

#### Voyant Pression huile moteur (rouge)

S'allume quand l'huile est à une pression insuffisante.



**Danger - Attention:** Si il s'allume pendant la marche, s'arrêter immédiatement, contrôler le niveau de l'huile et si nécessaire remplir le réservoir de

l'huile auprès d'un centre d'assistance autorisé MV Agusta (voir §3.8). Si le voyant s'allume alors que le niveau est correct, ne pas redémarrer et contacter un centre d'assistance autorisé MV Agusta.

#### Voyants Clignotants (vert)

Ils s'allument quand les clignotants sont allumés.

#### Voyant limiteur de tours (rouge)

Il s'allume avant l'intervention du limiteur, à un nombre de tours qui dépend du rapport de la vitesse enclenchée. Le limiteur intervient à 13000 tours/mn.

#### Voyant d'avertissement (orange)

Il s'allume pour signaler une panne. Si il s'allume pendant la conduite, contacter un centre de service agréé.

#### Voyant Batterie (rouge)

S'allume quand l'alternateur ne fournit pas une tension électrique suffisante pour charger la batterie. S'ils s'allume pendant la marche du véhicule, adressez-vous à un centre d'assistance autorisé.



### 3.7.2. Écran multifonctions

#### Compteur de vitesse

Indique la vitesse. La valeur peut apparaître en kilomètres-heure (Km/h) ou bien en milles par heure (Mph). La valeur maximum est de 300 Km/h (186 Mph).

#### Écran Rapport de vitesse

Indique le rapport de vitesse actuellement inséré. La position de point mort est indiquée par la chiffre "0".

#### Compteur kilométrique "TOTAL"

Indique le kilométrage total; de 0 à 999999 (Km ou mi)

#### Compteur kilométrique partiel 1 "TRIP 1"

Indique le kilométrage partiel; de 0 à 999.9 (Km ou mi)

#### Compteur kilométrique partiel 2 "TRIP 2"

Indique le kilométrage partiel; de 0 à 999.9 (Km ou mi)

#### Chronomètre

Indique les temps mesurés à l'aide de la fonction chronomètre

#### Écran ABS

Indique l'état d'activation de la fonction ABS.

#### Écran niveau contrôle traction

Indique le niveau du contrôle de traction actuellement sélectionné.

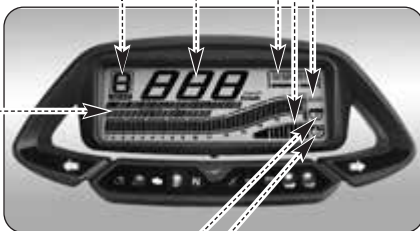

#### Écran mappage unité

Indique le mappage de l'unité actuellement sélectionnée.

#### Horloge

Indique l'heure en cours.

#### Thermomètre

Indique la température du liquide de refroidissement à travers l'allumage d'un nombre variable de segments sur une échelle de mesure graduée. Quand la température se trouve en dehors du champ de fonctionnement normal, les indications suivantes peuvent apparaître:

- sur l'écran apparaît un unique segment clignotant; c'est le signal de température faible.
- tous les segments sont allumés tandis que le segment supérieur clignote; c'est le signal de température élevée.



**Danger - Attention:** en cas de température élevée, arrêter le véhicule et contrôler le niveau du liquide de refroidissement. Au cas où il serait nécessaire de remplir le réservoir, s'adresser à un centre d'assistance autorisé MV Agusta (voir § 3.8). Si l'indication apparaît et que le niveau est correct, ne pas redémarrer et contacter un centre d'assistance autorisé MV Agusta.



## 3.8. Tableau des lubrifiants et liquides

Description	Produit préconisé	Caractéristiques
Huile moteur	Motul 7100 4T 5W40 (*)	SAE 5W/40
Liquide de refroidissement	Motul Motocool Factory Line	Produit à base de mono-éthylène glycol - Prêt à l'emploi - Sans adjonction d'eau
Liquide d'embrayage et freins	Motul DOT 3 & 4 Brake Fluid	DOT4
Huile de graissage de la chaîne	Motul Chain Lube Road	-

\* : Pour la disponibilité du produit conseillé, MV Agusta conseille de s'adresser directement aux propres concessionnaires autorisés. Le moteur de la motocyclette Brutale a été développé avec l'huile moteur Motul 7100 4T 5W40. Au cas où le lubrifiant décrit ne serait pas possible à trouver, MV Agusta conseille d'utiliser des huiles complètement synthétiques avec des caractéristiques conformes ou supérieures aux normes suivantes:

- Conforme API SN / SM
- Conforme JASO MA2
- Gradation SAE 5W40

**NOTE**

Les caractéristiques indiquées ci-dessus doivent être indiquées seules ou avec d'autres sur l'emballage de l'huile.





#### 4.1. Utilisation de la moto

Cette partie du livret expose les principaux points qui permettent une utilisation correcte de la moto.



##### **ATTENTION**

**La moto Brutale montre caractéristiques élevées de puissance et de performances; pour l'utilisation, il est donc requise un niveau adéquat de connaissance du véhicule. Lors de la première utilisation de la moto, il est nécessaire de garder une attitude prudente. Une agressive ou impulsive attitude de conduite peut augmenter les risques d'accidents et représenter un danger pour Votre sécurité et celle d'autrui.**



##### **ATTENTION**

**LES LIMITATIONS CONCERNANT L'UTILISATION ADMISE DU VEHICULE SONT REPORTÉES DANS LA SECTION "INFORMATIONS POUR LA SÉCURITÉ".**





## 4.2. Rodage



**Prudence - Précautions: le non respect des indications suivantes peut porter préjudice à la durée et aux performances de la moto.**

Le rodage est communément considéré comme une phase appliquée uniquement au moteur. En réalité, il est nécessaire également pour d'autres parties importantes de la moto, en particulier les pneumatiques, les freins, la chaîne de transmission etc. Durant les premiers kilomètres adopter une conduite tranquille.

### De 0 à 500 km (de 0 à 300 mi) (A)

Pendant cette période, varier fréquemment le régime de rotation du moteur. Si possible, préférer les parcours en colline légère avec beaucoup de virages et éviter les longues lignes droites.



### ATTENTION

**Les pneumatiques neufs doivent être soumis à un rodage adéquat pour atteindre une efficacité complète. Éviter les accélérations, les virages et les freinages brusques pendant les premiers 100 km. Si la période de rodage initial des pneus n'est pas respectée, il y a risque de dérapage ou de perte de contrôle du véhicule entraînant un grave danger d'accident.**



**De 500 à 1000 km (de 300 à 600 mi)**

Pendant cette période, éviter les efforts prolongés du moteur.



**De 1000 à 2500 km (de 600 à 1600 mi)**

Pendant cette période, il est possible de pousser un peu plus le moteur sans toutefois dépasser le régime indiqué.





#### 4.3. Démarrage du moteur



**ATTENTION:** Faire fonctionner le moteur dans un endroit fermé peut être dangereux. Les gaz d'échappement contiennent du monoxyde de carbone, un gaz incolore et inodore qui peut provoquer des décès ou des états graves. Ne faire fonctionner le moteur qu'à l'extérieur, au grand air.

► Tourner l'interrupteur de démarrage en position "ON"; l'instrumentation et les voyants exécutent le test de fonctionnement; pendant cette phase, s'assurer de l'allumage de tous les voyants présents sur le tableau de bord.

► Afin que le système d'interruption du circuit d'allumage donne son accord pour le démarrage, une des conditions suivantes doit être observée:

- Le levier de vitesses est en position de point mort avec le levier de l'embrayage tiré.
- Le levier de vitesses est enclenché sur une vitesse avec le levier de l'embrayage tiré et la béquille latérale relevée.

**NOTE:** Lorsqu'il manque moins de 1000 km à l'exécution de la prochaine intervention d'entretien programmé, on visualise sur l'afficheur la page de démarrage représentée ci-contre.





► Si le test de fonctionnement détecte un défaut sur le véhicule, l'écran affiche le message d'avertissement figurant dans l'image. En particulier, l'affichage montre le dispositif de la moto sur laquelle le défaut a été détectée.



► Appuyer sur le bouton "OK" afin d'afficher la fonction "RUN".

**ATTENTION**

Si un défaut a été détectée, ne pas démarrer le moteur et contacter un centre d'assistance autorisé MV Agusta.





#### ❑ Procédure de démarrage

- ▶ Appuyer sur le bouton de démarrage du moteur sans tourner la poignée de l'accélérateur.
- ▶ Dès que le moteur a démarré, relâcher le bouton.



#### Attention - précaution:

- Afin de ne pas endommager l'installation électrique, ne pas actionner le démarrage pendant plus de 5 secondes de suite.
- Ne pas faire fonctionner le moteur avec le véhicule à l'arrêt pendant trop longtemps. La surchauffe pourrait dans ce cas endommager les composants internes du moteur. Il est préférable d'amener le moteur à la bonne température en sélectionnant une vitesse réduite.
- Afin de prolonger au maximum la vie du moteur, ne pas accélérer à fond quand le moteur est froid.

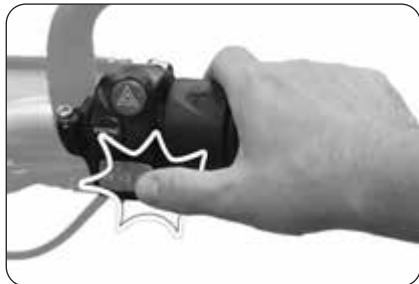



#### 4.4. Sélection et modification des fonctions à l'écran

L'instrumentation prévoit la possibilité d'intervenir sur certains des paramètres de mesure principaux.

Les opérations possibles sont:

- Sélection des modalités de fonctionnement:
  - “RUN” (Compteur kilométrique)
  - “SPEED LIMITER” (Limiteur de vitesse)
  - “TC” (Contrôle de la traction)
  - “CHRONO” (Chronomètre)
  - “ABS” (Système anti-blocage de frein)
  - “QUICK SHIFT” (Changement de vitesse rapide)
  - “CLOCK” (Horloge)
- Mise à zéro des fonctions des compteurs kilométriques partiels:
  - Compteur kilométrique Partiel 1 “TRIP 1”
  - Compteur kilométrique Partiel 2 “TRIP 2”
- Actionnement de la fonction chronomètre
- Configuration de l'horloge
- Modalité “IMMOBILIZER” (Système antivol)
- Sélection représentation de la centrale





#### 4.4.1. Sélection des fonctions écran

La sélection concerne les modes de fonctionnement suivants:

- "RUN" (Compteur kilométrique)
- "SPEED LIMITER" (Limiteur de vitesse)
- "TC" (Contrôle de la traction)
- "CHRONO" (Chronomètre)
- "ABS" (Système anti-blocage de frein)
- "QUICK SHIFT" (Changement de vitesse rapide)
- "CLOCK" (Horloge)

L'affichage des différents modes de fonctionnement se fait en appuyant sur le bouton "SET" pendant une durée inférieure à trois secondes. En appuyant sur ce bouton, les fonctions s'affichent à l'écran de façon cyclique. Sélectionner la fonction voulue.



#### ATTENTION:

Les opérations de modification ou de réglage des fonctions de l'écran doivent être effectuées avec le moteur coupé, le levier de vitesse au point mort, le véhicule arrêté et les pieds à terre. Il est interdit de changer les configurations de l'écran pendant la marche, sauf indication contraire.



#### ❑ Modalité “RUN”

Outre la fonction de compteur de vitesse, sur l'écran s'affichent les fonctions suivantes (voir §4.4.2.):

- Compteur kilométrique Total “TOTAL”
- Compteur kilométrique Partiel 1 “TRIP 1”

En alternative:

- Compteur kilométrique Total “TOTAL”
- Compteur kilométrique Partiel 2 “TRIP 2”

#### ❑ Modalité “SPEED LIMITER”

Cette fonction permet d'adapter la valeur maximale de la vitesse du véhicule selon vos propres exigences de conduite (voir § 4.4.3.).







#### ❑ Modalité “TC”

Cette fonction permet d'adapter le niveau de contrôle de la traction du moteur selon vos propres exigences de conduite (voir §4.4.4.).



#### ❑ Modalité “CHRONO”

Cette modalité permet l'actionnement de la fonction chronomètre et le stockage des données mesurées (voir §4.4.5.). Les fonctions affichées deviennent:

- |                     |                           |               |
|---------------------|---------------------------|---------------|
| • Chronomètre       | Parcours actuel           | “CURRENT LAP” |
| • Chronomètre       | Parcours le plus rapide   | “BEST LAP”    |
| • Chronomètre       | Parcours précédent        | “LAST LAP”    |
| • Compteur de tours | Nombre de tours parcourus | “N° LAP”      |





#### ❑ Modalité “ABS”

Ce mode de fonctionnement permet d'activer ou de désactiver le système anti-blocage de frein (ABS) (voir § 4.4.7.).



#### ❑ Modalité “QUICK SHIFT”

Cette fonction permet de activer ou désactiver le fonction de changement rapide de vitesse (voir §4.4.6.).





#### ❑ Modalité “CLOCK”

Cette fonction permet de modifier l'horaire (heures et minutes) reporté sur la planche de bord (voir §4.4.8.).





#### 4.4.2. Mise à zéro des fonctions des compteurs kilométriques partiels

Les valeurs des fonctions “TRIP 1” et “TRIP 2” peuvent être mise à zéro de la façon suivante.



#### ATTENTION

Les opérations de modification ou de réglage des fonctions de l'écran doivent être effectuées avec le moteur coupé, le levier de vitesse au point mort, le véhicule arrêté et les pieds à terre. Il est interdit de changer les configurations de l'écran pendant la marche.

- ▶ Accéder à la modalité “RUN”; la page-écran initiale indique les fonctions de compteur kilométrique total (“TOTAL”) et partiel 1 (“TRIP 1”).
- ▶ En appuyant sur le bouton “OK” pendant plus de trois secondes, on met la valeur “TRIP 1” à zéro.





► Appuyer sur le bouton "OK" pendant moins de trois secondes jusqu'à l'affichage de la fonction de compteur kilométrique partiel 2 ("TRIP 2").



► En appuyant sur le bouton "OK" pendant plus de trois secondes, on met la valeur "TRIP 2" à zéro.





#### 4.4.3. Modalité "SPEED LIMITER"

Lors du démarrage du moteur, la fonction "SPEED LIMITER" est désactivée. Pour l'activer, il est nécessaire d'effectuer les opérations suivantes:

- ▶ Appuyer sur le bouton "SET" afin d'accéder à la modalité "SPEED LIMITER". La valeur de la vitesse maximale montrée à l'écran (égale à la vitesse actuelle du véhicule) commence à clignoter.

**NOTE: Les opérations de modification ou de réglage de la vitesse maximale peuvent être effectuées même pendant l'utilisation du véhicule.**

- ▶ Appuyer sur le bouton "SET" pendant moins de trois secondes: la valeur de vitesse maximale est réduite de **2 km/h** en référence à celui affiché sur l'écran. D'autre part, en appuyant sur le bouton "OK" pour moins de trois secondes, la valeur de vitesse maximale est augmentée de **2 km/h** en référence à celui affiché sur l'écran.





- ▶ Appuyer sur le bouton "OK" pendant plus de trois secondes pour confirmer la valeur de la vitesse maximale sélectionnée. Le chiffre affiché cesse de clignoter et l'affichage revient à mode "RUN".
- ▶ D'autre part, en appuyant sur le bouton "SET" pendant plus de trois secondes, le fonction "SPEED LIMITER" est désactivée. L'écran affiche le légende "OFF". Après trois secondes, l'affichage revient à mode "RUN".

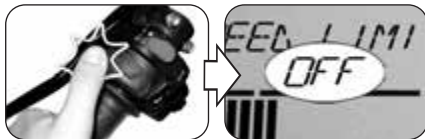

- ▶ Si le fonction "SPEED LIMITER" a été activée, lorsque la conduite du véhicule, la valeur de vitesse indiquée sur le compteur kilométrique se met à clignoter quand il atteint la valeur de la vitesse maximale sélectionnée.



#### 4.4.4. Modalité "TC"

► Appuyer sur le bouton "SET" afin d'accéder à la modalité "TC", puis appuyer sur le bouton "OK" pendant moins de trois secondes afin d'afficher "TC LEVEL". Le niveau actuel du contrôle de traction correspond à la valeur affichée à l'écran.

 **NOTE: Les opérations de modification ou de réglage du niveau de contrôle de traction peuvent être effectuées même pendant l'utilisation du véhicule.**

► En appuyant sur le bouton "OK" pendant moins de trois secondes, le niveau du contrôle de traction passe à la valeur suivante. D'autre part, en appuyant sur le bouton "SET" pour moins de trois secondes, le niveau de contrôle de traction diminue à la valeur inférieure. Cette valeur peut varier entre **0** et **8**.

► Appuyer sur le bouton "SET" pendant plus de trois secondes; la valeur choisie du niveau de contrôle de traction est confirmée.







#### 4.4.5. Chronomètre

##### □ Acquisition des temps de parcours

► Après avoir actionné la fonction chronomètre (modalité “CHRONO”) il est possible de lancer l’acquisition des données relatives aux temps de parcours.

► L’actionnement du bouton de clignotement du feu de route détermine le début de la mesure des données. Les points qui séparent les minutes des secondes et des dixièmes de seconde commencent à clignoter. L’instrument est en train d’acquérir les données.

**NOTE:** Lorsque le mode “CHRONO” est activée, la première pression du bouton de clignotement du feu de route active automatiquement le fonction “TC”. A partir de ce moment-là, il est possible de changer immédiatement le niveau de contrôle de traction en appuyant sur les boutons “SET” et “OK” (voir §4.4.4.).





► En appuyant à nouveau sur le bouton de clignotement du feu de route, la mesure du temps relatif au 1<sup>er</sup> tour parcouru est enregistrée. En même temps, l'instrument commence à acquérir le temps relatif au second tour.

La mesure du temps relatif au premier tour est conservée en mémoire et reste affichée pendant dix secondes, puis on affiche le temps concernant le tour successif.

► En continuant à utiliser le chronomètre, un temps est enregistré à chaque actionnement du bouton de clignotement. L'instrument a la possibilité d'effectuer un nombre maximum de 100 enregistrements consécutifs.

Durant l'affichage du temps concernant le tour qui vient de se terminer, l'afficheur indique le symbole “-” ou “+” si le temps relevé est respectivement inférieur ou supérieur au temps mesuré durant le tour précédent.





### ❑ Affichage des données

Une fois terminée la phase d'acquisition des temps, il est possible de les afficher.

► Accéder à la modalité "CHRONO"; cette page-écran affiche le temps concernant le tour le plus rapide ("BEST LAP") et le temps concernant le dernier tour parcouru ("LAST LAP").



### ATTENTION

Les opérations de modification ou de réglage des fonctions de l'écran doivent être effectuées avec le moteur coupé, le levier de vitesse au point mort, le véhicule arrêté et les pieds à terre. Il est interdit de changer les configurations de l'écran pendant la marche.

► Appuyer sur le bouton "OK" pendant moins de trois secondes afin d'afficher "LAPS VIEW".





► Une pression répétée sur la touche du clignotement du phare avant permet d'afficher l'un après l'autre tous les temps saisis précédemment à partir du dernier tour mémorisé.

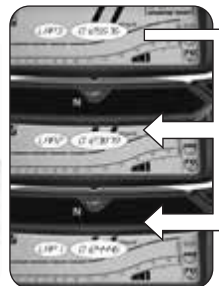

► Au terme de l'affichage des données, une pression sur la touche "SET" permet de revenir à la modalité "LAPS VIEW" pour passer à la modalité successive.





## ❑ Effacement des données

L'opération d'effacement des données enregistrées se fait en appliquant les procédures suivantes:



### ATTENTION

Les opérations de modification ou de réglage des fonctions de l'écran doivent être effectuées avec le moteur coupé, le levier de vitesse au point mort, le véhicule arrêté et les pieds à terre. Il est interdit de changer les configurations de l'écran pendant la marche.

► *Effacement d'un temps à la fois:* Accéder à la modalité "CHRONO" et appuyer sur le bouton "SET" pendant moins de trois secondes jusqu'à l'affichage du message "SINGLE LAP RESET".

► Appuyer sur le bouton "OK" pendant moins de trois secondes; la valeur du dernier temps sur le tour mémorisé commence à clignoter.





► Appuyer alors sur le bouton "OK" pendant plus de trois secondes pour effacer la valeur. Par contre, en appuyant sur le bouton "SET" pendant moins de trois secondes, la procédure d'effacement s'interrompt.

► Ensuite, une pression sur le bouton du clignotement du phare avant suivie d'une pression sur le bouton "OK" pendant plus de trois secondes permet d'effacer un à un tous les temps saisis précédemment.

► Au terme de l'effacement des données, une pression sur le bouton "SET" permet de revenir à la modalité "SINGLE LAP RESET" pour passer à la modalité successive.

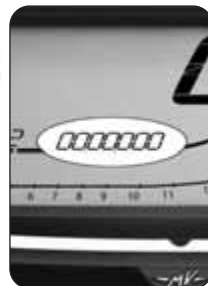



► *Effacement du meilleur temps:* Accéder à la modalité "CHRONO" et appuyer sur le bouton "SET" pendant moins de trois secondes jusqu'à l'affichage du message "BEST LAP RESET".



► Appuyer sur le bouton "OK" pendant moins de trois secondes; la valeur du temps sur le tour le plus rapide commence à clignoter.





► Appuyer alors sur le bouton “OK” pendant plus de trois secondes pour effacer la valeur. Par contre, en appuyant sur le bouton “SET” pendant moins de trois secondes, la procédure d’effacement s’interrompt.

► Au terme de l’effacement des données, une pression sur le bouton “SET” permet de quitter la modalité “BEST LAP RESET” pour passer à la modalité successive.

► *Effacement de tous les temps mémorisés:* Accéder à la modalité “CHRONO” et appuyer sur le bouton “SET” pendant moins de trois secondes jusqu’à l’affichage du message “ALL LAPS RESET”.

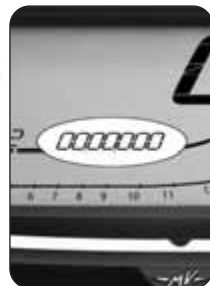





► Appuyer sur le bouton "OK" pendant moins de trois secondes; le display demande de confirmer l'effacement de toutes les données présentes en mémoire.



► En appuyant sur le bouton "OK" pendant plus de trois secondes, tous les temps saisis précédemment sont effacés. Si, en revanche, on appuie sur le bouton "SET" pendant moins de trois secondes la procédure d'effacement est interrompue.



► Au terme de l'effacement des données, une pression sur le bouton "SET" permet de quitter la modalité "ALL LAPS RESET" pour revenir à la modalité "CHRONO".



#### 4.4.6. Sélection des fonctions ABS

► Appuyer sur le bouton “SET” afin d’accéder à la modalité “ABS”; “SETTING ABS” apparaît sur l’écran.



#### ATTENTION

Les opérations de modification ou de réglage des fonctions de l’écran doivent être effectuées avec le moteur coupé, le levier de vitesse au point mort, le véhicule arrêté et les pieds à terre. Il est interdit de changer les configurations de l’écran pendant la marche.

► En appuyant sur le bouton “OK” pendant moins de quatre secondes, “ABS ON” commence à clignoter sur l’écran.

► Si vous n’appuyez sur aucune bouton, après trois secondes la sélection “ABS ON” est confirmée; dans cette condition, le système ABS est activé. Appuyer sur le bouton “SET” pour quitter le mode “ABS”.





- ▶ Par contre, en appuyant sur le bouton "OK" alors que la légende continue de clignoter, "ABS OFF" apparaît sur l'écran.
- ▶ Si vous n'appuyez sur aucune bouton, après trois secondes la sélection "ABS OFF" est confirmée; dans cette condition, le système ABS est désactivé. Appuyer sur le bouton "SET" pour quitter le mode "ABS".

**ATTENTION**

Si le système ABS est désactivé, le voyant correspondante sur le tableau de bord s'allume (voir § 3.7.1.). A partir de ce moment, le système antiblocage des freins n'est pas disponible lors du freinage. Adopter un style de conduite prudente et rouler à vitesse réduite, afin d'éviter de perdre le contrôle du véhicule pendant le freinage d'urgence.





#### 4.4.7. Modalité “QUICK SHIFT”

► Appuyer sur le bouton “SET” afin d’accéder à la modalité “QUICK SHIFT”. L’écran affiche l’état d’activation actuelle de la fonction de changement rapide de vitesse.



#### ATTENTION

Les opérations de modification ou de réglage des fonctions de l’écran doivent être effectuées avec le moteur coupé, le levier de vitesse au point mort, le véhicule arrêté et les pieds à terre. Il est interdit de changer les configurations de l’écran pendant la marche.

► Appuyer sur le bouton “OK” pendant moins de trois secondes; la légende d’activation de la fonction de changement rapide commence à clignoter.

► En appuyant sur le bouton “OK” pour moins de trois secondes, la légende permet de basculer de “OFF” sur “ON” et inversement.

► Appuyer sur “SET” pour confirmer l’état d’activation de la fonction de changement rapide de vitesse.





#### 4.4.8. Configuration de l'horloge

► Pour configurer l'heure, il faut appuyer sur le bouton "SET" de manière à visualiser le message "CLOCK SETTING".



#### ATTENTION

Les opérations de modification ou de réglage des fonctions de l'écran doivent être effectuées avec le moteur coupé, le levier de vitesse au point mort, le véhicule arrêté et les pieds à terre. Il est interdit de changer les configurations de l'écran pendant la marche.

► Appuyer sur le bouton "OK" pendant moins de trois secondes ; le chiffre de l'heure commence à clignoter.

► Appuyer de nouveau sur le bouton "OK", pendant moins de trois secondes, le chiffre de l'heure augmente et passe à la valeur successive.

► Appuyer sur le bouton "OK" pendant plus de trois secondes; le chiffre de l'heure choisi est confirmé. Par contre, si l'on appuie sur le bouton "SET" pendant moins de trois secondes la procédure de configuration est interrompue.

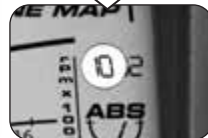
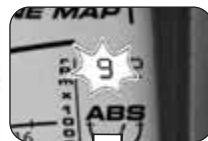



- ▶ Après avoir configuré le chiffre de l'heure, la planche de bord passe automatiquement à la configuration du chiffre des minutes. Le chiffre des minutes commence à clignoter.
- ▶ Appuyer sur le bouton "OK" pendant moins de trois secondes, le chiffre des minutes est augmenté et passe à la valeur successive.
- ▶ Appuyer sur le bouton "OK" pendant plus de trois secondes ; le chiffre des minutes choisi est confirmé et la planche de bord revient en mode "CLOCK". Par contre, si l'on appuie sur le bouton "SET" pendant moins de trois secondes la procédure de configuration est interrompue.

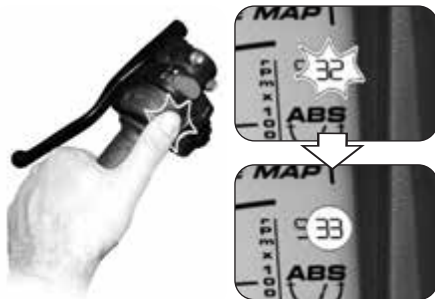



#### 4.4.9. Modalité “IMMOBILIZER”

La fonction “IMMOBILIZER” ne permet le démarrage du moteur qu’après avoir reconnu la clé de démarrage originale. De fait, celle-ci représente un système antivol intégré dans le circuit électronique du véhicule, car elle empêche l’utilisation de ce dernier par toute autre personne.

La modalité “IMMOBILIZER” du tableau de bord ne doit être utilisée qu’en cas de malfonctionnement. En effet, si pour une raison quelconque la clé originale n’est pas reconnue par le système, afin d’obtenir l’accord au démarrage du moteur il est nécessaire d’insérer le code secret reporté sur la MV Code Card reçue au moment de la livraison du véhicule.

▶ Enlever le cache à l’arrière de la MV Code Card et lire le code secret électronique correspondant à la clé de démarrage (sur la figure est représenté un code au hasard, à titre indicatif).

▶ Accéder à la modalité “RUN” et appuyer sur le bouton “SET” pendant plus de dix secondes afin d’afficher “IMMOBILIZER”.



**ATTENTION**

Les opérations de modification ou de réglage des fonctions de l'écran doivent être effectuées avec le moteur coupé, le levier de vitesse au point mort, le véhicule arrêté et les pieds à terre. Il est interdit de changer les configurations de l'écran pendant la marche.

- ▶ Appuyer sur le bouton "OK" pendant moins de trois secondes pour insérer le premier chiffre du code.
- ▶ La pression du bouton "OK" pendant moins de trois secondes permet de varier entre 0 et 9 la valeur relative au premier chiffre.
- ▶ Une fois sélectionné le chiffre voulu, appuyer sur le bouton "OK" pendant plus de trois secondes; le premier chiffre du code est confirmé. Il est alors possible d'insérer le deuxième chiffre du code.
- ▶ En procédant de manière analogue, il est possible de procéder à l'insertion des trois chiffres restants.







► Une fois complétée la procédure d'insertion du code, sur l'écran apparaît l'inscription "CONFIRM CODE". Appuyer sur le bouton "OK" pendant plus de trois secondes pour confirmer le code inséré.



► Si le code inséré est correctement reconnu par le système, l'inscription "VALID CODE" s'affiche. L'écran du tableau de bord retourne en modalité "RUN". Il est possible de démarrer le moteur.

► Si le code inséré est incorrect, l'inscription "NOT VALID CODE" s'affiche. Le système ne donne pas l'accord au démarrage du moteur; l'écran retourne en modalité "IMMOBILIZER". Répéter la procédure d'insertion du code depuis le début, en faisant attention à bien insérer correctement les chiffres reportés sur la MV Code Card fournie. En cas de problèmes, contacter un centre d'assistance autorisé MV Agusta.





#### 4.4.10. Sélection représentation de la centrale

Sur les modèles Brutale, il est possible de sélectionner différentes projections de l'unité ce qui permet d'obtenir des caractéristiques variables de puissance et de performances selon le type d'utilisation du véhicule.

##### NOTE

**Les opérations de sélection de la représentation de la centrale peuvent être effectuées même pendant l'utilisation du véhicule.**

La sélection du mappage de la centrale peut être effectuée en appuyant sur le bouton sur le côté droit du guidon. De cette manière le mappage passe à la valeur de réglage suivant. Les caractéristiques correspondantes au mappage sont indiquées dans le tableau suivant.

Mappage	N	R	S	C
Mode	Normal	Pluie	Sportif	Personnalisé





#### ❑ Réglage du mappage personnalisé

► Appuyer sur le bouton "ENGINE MAP" jusqu'à sélectionner le mappage "C" de l'unité de commande (mappage personnalisé).



**ATTENTION:** Les opérations de réglage du mappage personnalisé doivent être effectuées avec le levier de vitesse au point mort, le véhicule arrêté et les pieds à terre. Il est interdit de changer les configurations de l'écran pendant la marche.

► Appuyez sur "SET" jusqu'à ce que "SETTING CUSTOM MAP" est affiché.

Afin d'ajuster les paramètres du mappage personnalisé pour vos besoins de conduite, effectuer les opérations suivantes.

**NOTE:** Le mappage personnalisé peut être défini par le mélange des caractéristiques des mappages "Normale", "Plouie" et "Sportif" en la définition des paramètres suivants.

► *Sensibilité du commande d'accélérateur:* Appuyer sur le bouton "OK" pendant moins de trois secondes afin d'afficher "GAS SENSIVITY".





► Appuyer sur le bouton “SET” pendant moins de trois secondes. L'écran affiche le réglage actuel de la sensibilité du commande d'accélérateur.



► Appuyer sur le bouton “OK” pendant moins de trois secondes; le paramètre affiché commence à clignoter.

► Une pression répétée sur le bouton “OK” pendant moins de trois secondes permet d'afficher l'un après l'autre les paramètres suivants:

- “NORMAL” (Normal)
- “RAIN” (Pluie)
- “SPORT” (Sportif)

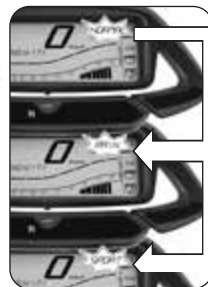



► Appuyer sur le bouton “OK” pendant plus de trois secondes; le nouveau réglage sera confirmée. La paramètre affiché cesse de clignoter et après quelques secondes l’affichage revient à le mode “GAS SENSITIVITY”. Il est possible de procéder à le réglage du paramètre suivant.



► *Couple maximal du moteur:* Appuyer sur le bouton “OK” pendant moins de trois secondes afin d’afficher “MAX ENGINE TORQUE”.





► Appuyer sur le bouton “SET” pendant moins de trois secondes. L'écran affiche le réglage actuel de la couple maximal du moteur.

► Appuyer sur le bouton “OK” pendant moins de trois secondes; le paramètre affiché commence à clignoter.

► Une pression répétée sur le bouton “OK” pendant moins de trois secondes permet d'afficher l'un après l'autre les paramètres suivants:

- “RAIN” (Pluie)
- “SPORT” (Sportif)





► Appuyer sur le bouton “OK” pendant plus de trois secondes; le nouveau réglage sera confirmée. La paramètre affiché cesse de clignoter et après quelques secondes l’affichage revient à le mode “MAX ENGINE TORQUE”.



► *Frein moteur:* Appuyer sur le bouton “OK” pendant moins de trois secondes afin d’afficher “ENGINE BRAKE”.





► Appuyer sur le bouton “SET” pendant moins de trois secondes. L'écran affiche le réglage actuel du frein moteur.



► Appuyer sur le bouton “OK” pendant moins de trois secondes; le paramètre affiché commence à clignoter.

► Une pression répétée sur le bouton “OK” pendant moins de trois secondes permet d'afficher l'un après l'autre les paramètres suivants:

- “NORMAL” (Normal)
- “SPORT” (Sportif)







► Appuyer sur le bouton “OK” pendant plus de trois secondes; le nouveau réglage sera confirmée. La paramètre affiché cesse de clignoter et après quelques secondes l’affichage revient à le mode “ENGINE BRAKE”.



► *Réponse du moteur:* Appuyer sur le bouton “OK” pendant moins de trois secondes afin d’afficher “ENGINE RESPONSE”.





► Appuyer sur le bouton “SET” pendant moins de trois secondes. L'écran affiche le réglage actuel de la réponse du moteur.



► Appuyer sur le bouton “OK” pendant moins de trois secondes; le paramètre affiché commence à clignoter.

► Une pression répétée sur le bouton “OK” pendant moins de trois secondes permet d'afficher l'un après l'autre les paramètres suivants:

- “SLOW” (Réponse lente)
- “FAST” (Réponse rapide)





► Appuyer sur le bouton “OK” pendant plus de trois secondes; le nouveau réglage sera confirmée. La paramètre affiché cesse de clignoter et après quelques secondes l’affichage revient à le mode “ENGINE RESPONSE”.



► *Limiteur de la vitesse de rotation du moteur:* Appuyer sur le bouton “OK” pendant moins de trois secondes afin d’afficher “RPM LIMITER”.





► Appuyer sur le bouton “SET” pendant moins de trois secondes. L'écran affiche le réglage actuel du limiteur de la vitesse de rotation du moteur.



► Appuyer sur le bouton “OK” pendant moins de trois secondes; le paramètre affiché commence à clignoter.

► Une pression répétée sur le bouton “OK” pendant moins de trois secondes permet d'afficher l'un après l'autre les paramètres suivants:

- “NORMAL” (Normal)
- “SPORT” (Sportif)





► Appuyer sur le bouton "OK" pendant plus de trois secondes; le nouveau réglage sera confirmée. La paramètre affiché cesse de clignoter et après quelques secondes l'affichage revient à le mode "RPM LIMITER".



► Appuyer sur le bouton "OK" pendant moins de trois secondes jusqu'à ce que l'affichage passe au mode "RUN". Le réglage du mappage personnalisé est terminée.





#### 4.4.11. Messages d'avertissement/pannes

Le tableau de bord peut signaler la présence d'une faute ou un dysfonctionnement au cours des différentes conditions d'utilisation de la moto.

► *Démarrage du moteur:* En tournant l'interrupteur de démarrage en position "ON"; l'instrumentation et les voyants exécutent le test de fonctionnement. Si le test de fonctionnement détecte un défaut sur le véhicule, l'écran affiche le message d'avertissement figurant dans l'image. En particulier, l'affichage montre le dispositif de la moto sur laquelle le défaut a été détectée.

► Appuyer sur le bouton "OK" afin d'afficher la fonction "RUN". Les feux de détresse (clignotants) commencent à clignoter.



#### ATTENTION

**Si un défaut a été détectée a moteur coupé, ne pas démarrer le moteur et contacter un centre d'assistance autorisé MV Agusta.**





► *Marche du véhicule*: Si une anomalie est détectée pendant l'utilisation du véhicule, la partie inférieure de l'écran affiche le message d'avertissement figurant dans l'image. Les feux de détresse (clignotants) commencent à clignoter.

**ATTENTION**

**Si un défaut a été détectée pendant la marche, arrêter le véhicule et contacter un centre d'assistance autorisé MV Agusta.**



► Après l'arrêt du véhicule, l'affichage montre le dispositif de la moto sur laquelle le défaut a été détectée.



► *Température élevée du liquide de refroidissement:*  
Si une température élevée du fluide de refroidissement est détectée, l'écran affiche le message d'avertissement figurant dans l'image. Ce message peut apparaître lors de toutes les conditions d'utilisation du véhicule.



**ATTENTION:** En cas de température élevée, arrêter le véhicule et contrôler le niveau du liquide de refroidissement. Au cas où il serait nécessaire de remplir le réservoir, s'adresser à un centre d'assistance autorisé MV Agusta (voir § 3.8). Si l'indication apparaît et que le niveau est correct, ne pas redémarrer et contacter un centre d'assistance autorisé MV Agusta.







#### 4.5. Approvisionnement en carburant



**Danger - Attention:** l'essence et ses vapeurs sont extrêmement inflammables et nocifs. Eviter le contact et l'inhalation. Pendant l'approvisionnement, couper le moteur, ne pas fumer, tenir à distance les flammes, étincelles et sources de chaleur. Effectuer l'approvisionnement à l'air libre ou dans un local suffisamment aéré.



**Rappel - Précaution:** N'utiliser que du carburant présentant les caractéristiques suivantes:

- Essence sans plomb
- Teneur en éthanol jusqu'à 10% en volume
- Indice d'octane (R.O.N.) de 95 ou plus



Cette nécessité est rappelé par une pastille verte sur le côté inférieur du bouchon du réservoir et par la plaquette "E10" qui se trouve sur le réservoir.



- ▶ Soulever le cache poussière.
- ▶ Introduire la clé, tourner dans le sens des aiguilles d'une montre.







► Soulever le couvercle et effectuer le ravitaillement en carburant.

 **ATTENTION:** Un remplissage excessif du réservoir peut faire déborder le carburant à cause de l'expansion due à la chaleur du moteur ou à l'exposition de la moto à la lumière du soleil. Les écoulements éventuels de carburant peuvent provoquer des incendies. Le niveau de carburant dans le réservoir ne doit jamais dépasser la base de l'embout de remplissage.

► Une fois l'approvisionnement effectué, pousser le bouchon vers le bas en tournant simultanément la clé dans le sens des aiguilles d'une montre pour faciliter la fermeture, puis relâcher la clé et l'extraire.

 **Rappel - Précaution:** sécher immédiatement avec un chiffon propre le carburant éventuellement renversé, car il peut détériorer les peintures ou les plastiques.

 **ATTENTION:** Vérifier que le bouchon du réservoir à carburant est fermé correctement avant d'utiliser le véhicule.

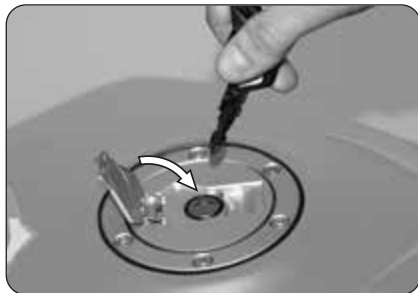



#### 4.6. Dépose de la selle passager

- ▶ Introduire la clé dans la serrure.
- ▶ Tourner la clé dans le sens inverse des aiguilles d'une montre et simultanément appuyer légèrement sur la selle. Soulever et enlever la selle comme le montre la figure.

Pour remonter l'élément, procéder de la façon suivante:

- Tourner la clé dans la serrure;
- Repositionner et accrocher la selle;
- Presser la selle;
- Relâcher la clé;
- Presser à nouveau la selle en s'assurant qu'elle est fermement accrochée à la structure.



#### ATTENTION

Après avoir enlevé et remis la selle, et en tout cas avant d'utiliser la moto, s'assurer que l'élément a été placé correctement et qu'il est fermement assujéti à la structure portante du véhicule.

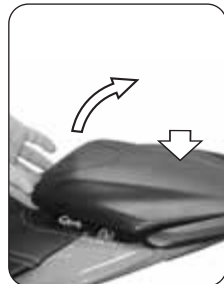
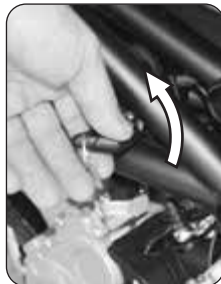



#### 4.7. Dépose de la selle pilote

► Enlever la selle passager en suivant les indications du paragraphe §4.6.

► Démontez les deux vis de fixation arrière avec ses entretoises en utilisant un tournevis hexagonal de 4 mm. Soulever et enlever la selle comme le montre la figure.

Pour remonter l'élément, procéder de la façon suivante:

- Repositionner la selle;
- Remonter les deux vis de fixation arrière avec ses entretoises;
- Remonter la selle passager en suivant les indications du paragraphe §4.6.



#### ATTENTION

Après avoir enlevé et remis la selle, et en tout cas avant d'utiliser la moto, s'assurer que l'élément a été placé correctement et qu'il est fermement assujéti à la structure portante du véhicule.





#### 4.8. Stationnement de la moto

##### □ Stationnement avec béquille latérale



**ATTENTION:** Garer la moto en conditions de sécurité et sur un terrain stable. Pour le stationnement en côte, garer la moto avec la roue avant en amont et la première vitesse engagée. Ne pas oublier de remettre le sélecteur de vitesses au point mort avant de redémarrer la moto. Ne pas laisser le véhicule sans surveillance avec la clé sur le contact.



**ATTENTION:** Lorsque le véhicule stationne sur la béquille latérale, il est dangereux de s'asseoir dessus et de peser avec tout le poids du corps sur l'unique appui de stationnement. Avant de se mettre en route, vérifier le fonctionnement de l'interrupteur de sûreté en s'assurant que le voyant d'ouverture de la béquille latérale sur le tableau de bord s'éteint. Dans tous les cas, vérifier que la béquille est bien rentrée. En cas de fonctionnement défectueux, faire contrôler le dispositif par un concessionnaire MV Agusta avant d'utiliser la moto.

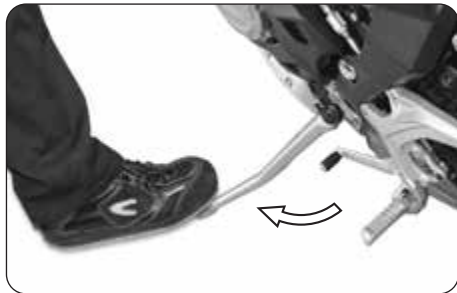

- ▶ Abaisser la béquille avec le pied jusqu'à la butée et incliner lentement la moto pour mettre le pied d'appui au contact du sol.



### □ Stationnement avec la béquille arrière

Introduire l'axe de béquille dans l'orifice de l'axe de roue arrière du côté gauche de la moto. Appuyer la béquille au sol et en forçant dessus, soulever le véhicule jusqu'à ce qu'il se stabilise.



#### ATTENTION

Cette opération doit être effectuée par deux personnes.

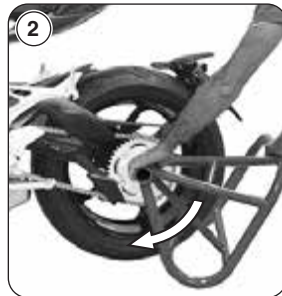



## 5.1. Liste des réglages

La moto dispose d'une grande diversité de réglages qui peuvent améliorer l'ergonomie, l'assiette et la sécurité.

Toutefois, étant donné qu'un réglage incorrect de pièces particulièrement importantes peut engendrer une situation de danger, quelques-uns des réglages sont réservés aux Centres d'Assistance MV Agusta.



### ATTENTION

Tous les réglages s'effectuent à l'arrêt.



(F) Réglage du rétroviseur (§5.6.)

(A) Réglage du levier  
de frein avant (§5.3.)

(H) Réglage de la suspension avant §5.7.)

(M) Orientation du phare (§5.9.)

(D) Réglage de la pédale  
de frein arrière (§5.2.)







(F) Réglage du rétroviseur (§5.6.)

(E) Réglage de l'amortisseur de direction  
(Brutale RR) (§5.5.)

(B) Réglage du levier  
d'embrayage (§5.4.)

(L) Réglage de la suspension arrière  
(§5.8.)

(C) Réglage du sélecteur  
de vitesses (§5.2.)

(G) Réglage de la chaîne (§5.2.)

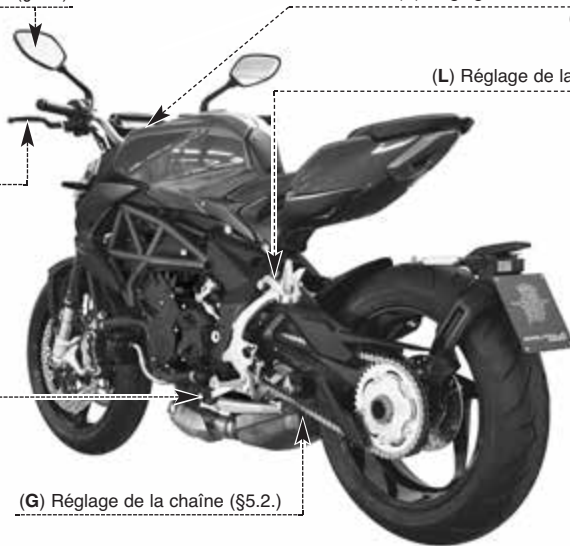



## 5.2. Tableau des réglages

	<b>A - Réglage du levier de frein avant:</b> pour améliorer la prise en fonction des nécessités du pilote (§5.3.).		<b>G - Tension de la chaîne:</b> pour l'efficacité et la fiabilité de la transmission.
	<b>B - Réglage du levier d'embrayage:</b> pour améliorer la prise en fonction des nécessités du pilote (§5.4.).		<b>H - Réglage de la suspension avant:</b> pour adapter la réponse aux préférences du motard, on peut régler: <ul style="list-style-type: none"><li>- la précharge du ressort (§5.7.1.)</li><li>- le dispositif hydraulique de freinage en détente (§5.7.2.)</li><li>- le dispositif hydraulique de freinage en compression (§5.7.3.)</li></ul>
	<b>C - Réglage du sélecteur de vitesses:</b> pour améliorer le mouvement de commande en fonction des nécessités du pilote.		<b>L - Réglage de la suspension arrière:</b> pour adapter la réponse aux préférences du motard, on peut régler: <ul style="list-style-type: none"><li>- la hauteur d'assiette</li><li>- la précharge du ressort</li><li>- le dispositif hydraulique de freinage en détente (§5.8.1.)</li><li>- le dispositif hydraulique de freinage en compression (§5.8.2.)</li></ul>
	<b>D - Réglage de la pédale de frein arrière:</b> pour améliorer le mouvement de commande en fonction des nécessités du pilote.		<b>M - Orientation du phare:</b> pour optimiser la profondeur du faisceau lumineux en fonction de l'assiette (§5.9.).
	<b>E - Réglage de l'amortisseur de direction (Brutale RR):</b> pour adapter la dureté de la direction aux préférences du pilote (§5.5.).		
	<b>F - Réglage des rétroviseurs:</b> pour améliorer l'orientation (§5.6.). <b>ATTENTION:</b> Ne pas toucher la vis de fixation du rétroviseur au guidon. En cas de besoin, s'adresser à un concessionnaire MV Agusta.		



### 5.3. Réglage du levier de frein avant

Tourner la manette de réglage du levier pour en modifier la position.

Dans le sens horaire; le levier s'approche de la manette. Dans le sens antihoraire: le levier s'éloigne de la manette.



### 5.4. Réglage du levier d'embrayage

Tourner la manette de réglage du levier pour en modifier la position.

Dans le sens horaire; le levier s'approche de la manette. Dans le sens antihoraire: le levier s'éloigne de la manette.

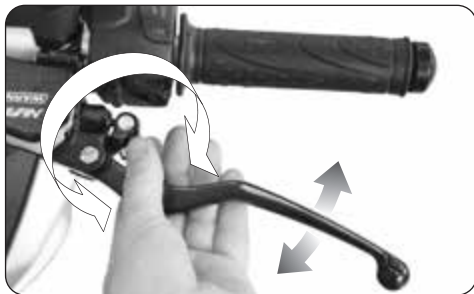



### 5.5. Réglage de l'amortisseur de direction (Brutale RR)

Le réglage standard s'obtient en tournant le pommeau dans le sens inverse des aiguilles d'une montre jusqu'au maximum; dans cette position l'amortisseur offre la résistance minimale de la direction. En fonction de vos exigences de conduite il est possible d'augmenter graduellement l'action freinante de l'amortisseur de direction en tournant le pommeau dans le sens des aiguilles d'une montre.

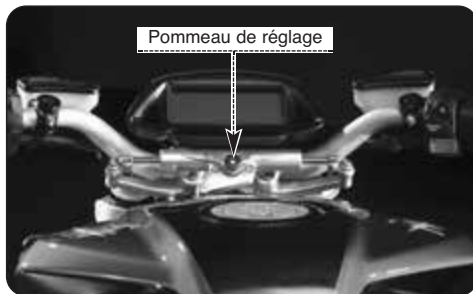



### 5.6. Réglage des rétroviseurs

Tourner le corps du rétroviseur pour orienter le rétroviseur dans les quatre directions.

Régler les deux rétroviseurs. Pour une mise au point optimale, monter sur le véhicule pour réaliser le réglage.



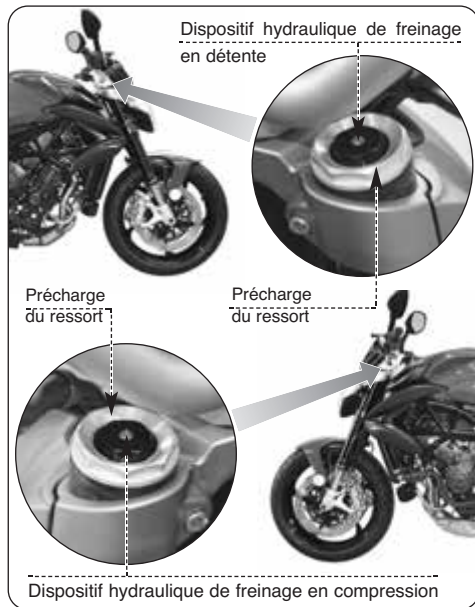

## 5.7. Réglage de la suspension avant

**NOTE:** L'ajustement des suspensions doit être de préférence effectué avec le réservoir de carburant plein.

### 5.7.1. Précharge du ressort (suspension avant)

Le réglage s'effectue en partant de la position standard. Pour trouver cette position, il faut dévisser à fond, puis visser jusqu'à la position standard (voir tableau annexe).

Visser pour augmenter la précharge du ressort ou dévisser pour la diminuer.





### 5.7.2. Dispositif hydraulique de freinage en détente (suspension avant)

Le réglage s'effectue en partant de la position standard. Pour trouver cette position, il faut visser à fond, puis dévisser jusqu'à la position standard (voir tableau annexe).

Visser pour augmenter l'action du freinage ou dévisser pour la diminuer.

### 5.7.3. Dispositif hydraulique de freinage en compression (suspension avant)

Le réglage s'effectue en partant de la position standard. Pour trouver cette position, il faut visser à fond, puis dévisser jusqu'à la position standard (voir tableau annexe).

Visser pour augmenter l'action du freinage ou dévisser pour la diminuer.





### 5.8. Réglage de la suspension arrière



#### ATTENTION

L'amortisseur contient du gaz sous haute pression. Ne pas tenter de le démonter sous aucun prétexte.

**NOTE:** L'ajustement des suspensions doit être de préférence effectué avec le réservoir de carburant plein.

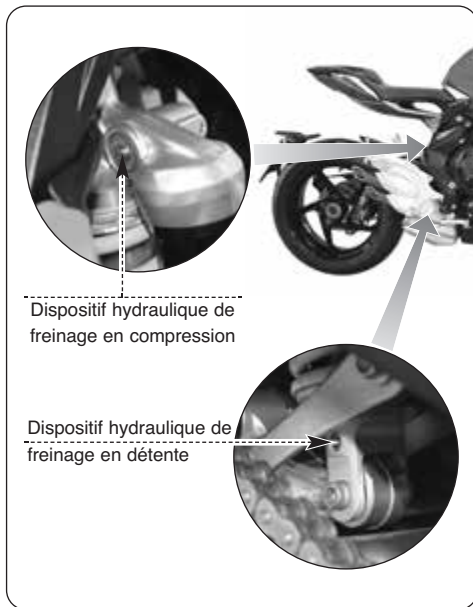

Dispositif hydraulique de freinage en compression

Dispositif hydraulique de freinage en détente





### 5.8.1. Dispositif hydraulique de freinage en détente (suspension arrière)

Le réglage s'effectue en partant de la position standard. Pour trouver cette position, il faut visser à fond, puis dévisser jusqu'à la position standard (voir tableau).

Visser pour augmenter l'action du freinage ou dévisser pour la diminuer.

### 5.8.2. Dispositif hydraulique de freinage en compression (suspension arrière)

Le réglage s'effectue en partant de la position standard. Pour trouver cette position, il faut visser à fond, puis dévisser jusqu'à la position standard (voir tableau).

Visser pour augmenter l'action du freinage ou dévisser pour la diminuer.





### 5.9. Réglage du projecteur avant

Placer le véhicule à 10 mètres d'une paroi verticale.

Veiller à ce que le terrain soit plat et l'axe du véhicule perpendiculaire à la paroi.

Le véhicule doit se trouver en position verticale. Mesurer la hauteur du centre du projecteur au sol et faire une croix sur la paroi à la même hauteur.

Allumer le code, la limite supérieure de démarcation entre la zone sombre et la zone éclairée ne doit pas dépasser  $9/10$  de la hauteur au sol du centre du projecteur.

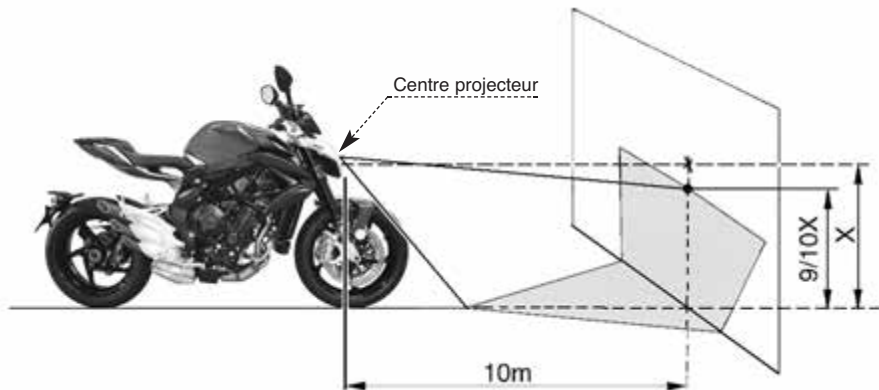



Pour la mise au point du phare antérieur, agir sur la vis représentée ci-contre. Dans le sens des aiguilles d'une montre: le phare s'incline vers le bas. Dans le sens contraire de celui des aiguilles d'une montre: le phare s'incline vers le haut. L'inclinaison peut varier de  $\pm 4^\circ$  par rapport à la position standard

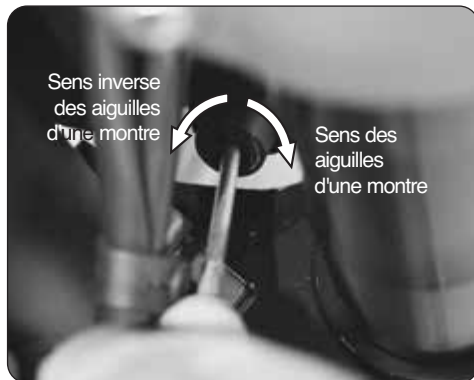



### Note d'information

MV Agusta Motor S.p.A. poursuit une politique de continuelle amélioration de ses produits. Pour cette raison, de légères différences pourraient éventuellement se présenter entre les informations de ce livret et le véhicule que vous avez acheté. Les modèles MV Agusta s'exportent dans de nombreux pays où des normes différentes sont en vigueur en ce qui concerne le Code de la Route et les procédures d'homologation. En espérant pouvoir compter sur votre compréhension, il est indispensable à MV Agusta Motor S.p.A. de se réserver le droit d'apporter des modifications à ses produits et à la documentation technique à tout moment sans fournir de préavis.

Nous suggérons de visiter souvent le site Internet **[www.mvagusta.it](http://www.mvagusta.it)** afin d'obtenir des informations et des mises à jour sur les produits MV Agusta et la documentation relative.



### Respectons et défendons l'environnement

Toutes nos actions ont des répercussions sur la planète entière et sur ses ressources. MV Agusta, au profit des intérêts de tous, sensibilise les Clients et les opérateurs du service après-vente pour leur faire adopter des modalités d'utilisation du véhicule et de traitement de ses parties dans le respect des normes en vigueur en terme de pollution, traitement et recyclage des déchets.

© 2017

Toute reproduction même partielle de ce document est formellement interdite sans autorisation écrite de MV Agusta Motor S.p.A.

Dét. n° 8000C5107

Edition n° 1 - Novembre 2017



## NOTES

FR 5

A series of horizontal dotted lines for writing notes, spanning the width of the page.

**BRUTALE  
8000-RR**

**MV AGUSTA**



**Bedienungsanleitung**  
*Deutsche Version*

*Sehr geehrter Kunde,*

*wir danken Ihnen für das Vertrauen, dass Sie uns ausgesprochen haben und gratulieren Ihnen zur Wahl Ihres neuen Brutale.*

*Dank dem beharrlichen Einsatz und Engagement seiner Techniker ist heute MV Agusta in der Lage seinen zahlreichen Fans ein innovatives und von einer Sonderverkleidung und raffinierter Radtechnologie charakterisiertes Produkt anzubieten: Elemente die alle mit dem MV Agusta Warenzeichen verzeichneten Erzeugnisse in der langen Zeitspanne seiner ruhmreichen Unternehmensgeschichte gekennzeichnet haben.*

*Das Ergebnis ist ein exklusives Motorrad, das dank seinen ästhetischen und funktionellen Eigenschaften sowie den zahlreichen technischen Innovationen weit über den heutigen auf diesem Markt vertriebenen Qualitätsprodukten liegt.*

*Die angewandten Lösungen verleihen dem neuen Brutale einen unverwechselbaren Charakter, der dieses Motorrad zu den anderen Modellen der Familie MV Agusta anknüpft und die Projektphilosophie dieses Unternehmens, das der ständigen Forschung, und der technologischen Innovation besonders Wert schenkt und das winzigste Detail schätzen kann, konsolidiert. Jedem Motorradfahrer wird somit die Möglichkeit geschenkt, seine Leidenschaft in voller Freiheit zu genießen und zur gleichen Zeit ein Motorrad zu besitzen, das einzig auf der Welt ist und sich weltweit mit starkem Übergriff durchsetzt.*

*Falls Sie weitere Informationen wünschen, wenden Sie sich bitte an den Kundendienst der MV Agusta.*

*Viel Spaß!*

*Giovanni Castiglioni  
Präsident  
MV Agusta*



## ALLGEMEINES INHALTSVERZEICHNIS

<i>Kap.</i>	<i>Inhalt</i>	<i>Seite</i>
<b>1</b>	<b>ALLGEMEINE INFORMATIONEN</b>	<b>5</b>
1.1.	Zweck der Bedienungsanleitung	5
1.2.	Zeichenerklärung	6
1.3.	Lieferschein	7
1.4.	Rahmen - und Motornummer	8
<b>2</b>	<b>SICHERHEITSINFORMATIONEN</b>	<b>11</b>
2.1.	Fahrzeuggarantie	11
2.2.	Nach dem Wartungsplan Fällige Wartung	12
2.3.	Fahrzeugbeladung	14
<b>3</b>	<b>BEDIENUNGSELEMENTE UND INSTRUMENTE</b>	<b>15</b>
3.1.	Anbringung der Bedienelemente und Instrumente	15
3.2.	Seitlicher Ständer	17
3.3.	Bedienelemente links am Lenker	18
3.4.	Bedienelemente rechts am Lenker	20
3.5.	Zündschloß und Lenkerschloß	23
3.6.	Schaltung	26
3.7.	Instrumente und Kontrolllampen	27
3.7.1.	Kontrolllampen	28
3.7.2.	Multifunktions-Display	29
3.8.	Schmiermitteltabelle	30

<i>Kap.</i>	<i>Inhalt</i>	<i>Seite</i>
<b>4</b>	<b>EINSATZ</b>	<b>31</b>
4.1.	Einsatz des Motorrads	31
4.2.	Einfahren	32
4.3.	Starten des Motors	34
4.4.	Auswahl und Einstellung der Display-Funktionen	37
4.4.1.	Auswahl der Display-Funktionen	38
4.4.2.	Nullstellen der Funktionen des Teilstrecken-Kilometerzählers	43
4.4.3.	Betriebsmodus "SPEED LIMITER"	45
4.4.4.	Betriebsmodus TC	47
4.4.5.	Zeitmessung	48
4.4.6.	Auswahl der ABS-Funktionen	57
4.4.7.	Betriebsmodus "QUICK SHIFT"	59
4.4.8.	Einstellung der Uhr	60
4.4.9.	Betriebsmodus "IMMOBILIZER"	62
4.4.10.	Auswahl Mapping Motorsteuerung	65
4.4.11.	Warnung / Störmeldung	77
4.5.	Tanken	80
4.6.	Entfernung des Beifahrersitzes	82
4.7.	Entfernung des Fahrersitzes	83
4.8.	Parken des Motorrads	84





<i>Kap.</i>	<i>Inhalt</i>	<i>Seite</i>
<b>5</b>	<b>EINSTELLUNGSARBEITEN</b>	<b>86</b>
5.1.	Liste der Einstellungsarbeiten	86
5.2.	Tabelle der Einstellungsarbeiten	89
5.3.	Einstellung Bremshebel Vorderradbremse	90
5.4.	Einstellung des Kupplungshebels	90
5.5.	Einstellung Lenkungsdämpfer (Brutale RR)	91
5.6.	Einstellung Rückspiegel	92
5.7.	Einstellung vordere Federung	93
5.7.1.	Federvorspannung (Vorderradfederung)	93
5.7.2.	Hydraulische Ausdehnungsbremse (Vorderradfederung)	94
5.7.3.	Hydraulische Kompressionsbremse (Vorderradfederung)	94
5.8.	Einstellung hintere Federung	95
5.8.1.	Hydraulische Ausdehnungsbremse (Hinterradfederung)	96
5.8.2.	Hydraulische Kompressionsbremse (Hinterradfederung)	96
5.9.	Scheinwerfereinstellung	97



## 1.1. Zweck der Bedienungsanleitung

Dieses Handbuch enthält alle für einen korrekten und sicheren Gebrauch Ihres Motorrads erforderlichen Informationen.

Das Handbuch wird in elektronischem Format (.pdf) auf dieser Speichermedium geliefert und kann auf jedem PC mit Windows oder Mac eingesehen oder ausgedruckt werden.

Wir bitten Sie, dieses Handbuch vor der ersten Benutzung des Motorrads aufmerksam durchzulesen und sich immer zu vergewissern, dass auch andere Personen, die das Motorrad benutzen, dies tun.

Auf dem Datenträger, der im Lieferumfang enthalten ist, finden Sie neben diesem Handbuch auch das Wartungshandbuch, das Vertragshändlerhandbuch und das Garantieheft.



Copyright  
MV AGUSTA Motor Spa  
Alle Rechte vorbehalten



## 1.2. Zeichenerklärung

Besonders wichtige Textstellen die sich auf die Sicherheit der Personen oder des Fahrzeugs beziehen, sind mit folgenden Symbolen gekennzeichnet:



**Gefahr - Achtung: Die mangelnde oder unvollständige Beachtung dieser Vorschriften stellt eine schwere Unfallgefahr für den Arbeiter oder Dritte dar.**



**Vorsicht - Vorsichtsmaßnahme: Die Nichteinhaltung der Anweisungen kann schwere und dauerhafte Schäden am Fahrzeug verursachen.**

Folgende Symbole werden benutzt, um anzuzeigen, wer die angegebenen Wartungs- und Einstellarbeiten ausführen darf:



**Informationen zu Arbeiten, die vom Motorradfahrer ausgeführt werden dürfen.**



**Informationen zu Arbeiten, die ausschließlich von ausgebildetem Fachpersonal ausgeführt werden dürfen.**

Um weitere Informationen hervorzuheben, werden folgende Symbole verwendet:



Das Symbol  zeigt an, dass für die richtige Durchführung der angegebenen Arbeit ein Spezialwerkzeug oder Sonderausrüstung benötigt werden.



Das Zeichen “§” gefolgt von einer Ziffer verweist auf das entsprechende Kapitel.



## 1.3. Lieferschein

Bei der Übergabe des Motorrades hat Ihnen Ihr Händler auch das Garantiebescheinigung ausgehändigt.

Bewahren Sie es bitte sorgfältig zusammen mit den Fahrzeugpapieren und den zukünftigen Bescheinigungen auf, die Sie bei jeder Inspektion ausgehändigt bekommen werden.

### **WICHTIG**

Die Kopien der Garantiebescheinigung sowie der Bescheinigung der vor Auslieferung vorgenommenen Kontrollen müssen vom Vertragshändler ausgefüllt werden. Eine Kopie muss dem Kunden übergeben werden, eine muss vom Vertragshändler aufbewahrt und eine an den Importeur geschickt werden.

Die Kopie der Wartungcoupons muss immer vom Vertragshändler ausgefüllt werden. Es muss vom Kunden aufbewahrt werden.



#### 1.4. Rahmen- und Motornummer

- 1) Rahmennummer
- 2) Motornummer
- 3) Zulassungsnummer

##### ► Kennzeichnung des Motorrads

Das Motorrad wird durch die Rahmennummer eindeutig gekennzeichnet. Bei Ersatzteilbestellungen müssen die Rahmennummer und gegebenenfalls auch die Motornummer, die Farbkennziffer und die Schlüsselnummer angegeben werden.

Wir empfehlen Ihnen die wichtigsten Angaben nachstehend einzutragen.

**RAHMENNUMMER:** \_\_\_\_\_

**MOTORNUMMER:** \_\_\_\_\_



## ► Schlüsselnummer

Sie erhalten einen Schlüssel und einen Ersatzschlüssel. Die Schlüssel dienen als Zündschlüssel und zum Öffnen aller Schlösser. Den Ersatzschlüssel an einem sicheren Ort aufbewahren.

Bei Nachfrage eines Duplikates ist die Kenntnis der Identifikationsnummer des Schlüssels grundlegend. Die Schlüssel-Identifizierungsnummer ist auf der MV Code Card angegeben, die zusammen mit den Zündschlüsseln geliefert wird.

## ► Farbkennziffer

Die Farbkennziffer wird bei Bestellung von Karosserieteilen benötigt. Sie befindet sich an der hinteren unteren Seite des Kraftstofftanks.

Um das Farbkennzifferschild zu lesen, müssen der Beifahrersitz und der Fahrersitz, wie in den Abschnitten §4.6. und §4.7. beschrieben, entfernt werden.



1 DE





DE  
1

Nach Sattelbeseitigung, ist es möglich, das Farbkennzifferschild zu sehen. Auf dem Schild ist die jeweilige Farbekennziffer des Motorrads zur Lackierung der Karosserieteile angegeben.

Es wird geraten, die Farbkennziffer des Motorrads im nachfolgenden Leerraum einzutragen:

**FARBKENNZIFFER:** .....

Um die Farbkennziffer der lackierten Teile in Verhältnis zu der Farbcode des Motorrads zu erhalten, lesen Sie das Wartungsanleitung auf der mitgelieferten Speichermedium.





## 2.1. FAHRZEUGGARANTIE



### ACHTUNG

Wir weisen darauf hin, dass die Garantie im Falle der Verwendung des Fahrzeugs bei Motorradwettbewerben, die auf der Piste oder auf einer öffentlichen Straße durchgeführt werden, nicht greift, da es sich um eine Verwendung handelt, die sich von der Verwendung auf der Straße, für die Ihr Fahrzeug ausdrücklich entwickelt wurde, unterscheidet und nicht mit dieser kompatibel ist.

Außerdem greift die Garantie nicht, wenn das Fahrzeug für berufliche Tätigkeiten verwendet wird, wie zum Beispiel, aber nicht erschöpfend, Taxidienst, Vermietung, usw.

Wir weisen außerdem darauf hin, dass MV Agusta sich vorbehält, das Greifen der Garantie ausnahmslos in allen Fällen zu beurteilen, in denen festgestellt werden sollte, dass Ihr Fahrzeug hinsichtlich seiner ursprünglichen Konfiguration verändert wurde, und das

auch mit Originalersatzteilen und/oder -zubehör von MV Agusta, die/das vom Kundendienst bei einem Vertragshändler von MV Agusta eingebaut wurde(n).

Wir betonen außerdem, dass die Garantie nicht greift, wenn jeder Eingriff, egal ob es sich um Wartungscoupons oder um jeglichen anderen Reparatur-, Einstellungs-, Austausch Eingriff oder eine andere Art von Eingriff handelt, von Werkstätten und/oder Technikern und/oder Wartungs- und Reparaturzentren und im Allgemeinen von jeglichen dritten Personen durchgeführt wird, die nicht gemäß den Technik- und Verfahrensstandards gearbeitet haben, die MV dem technischen Fachpersonal für die korrekte Wartung des Fahrzeugs (technische Kurse; spezielle Werkstattwerkzeuge; Handbücher; Originalersatzteile; usw.) von MV Agusta zur Verfügung stellt, und/oder keine Originalersatzteile und/oder -zubehör von MV Agusta verwendet haben.





Auf jeden Fall erklären wir Ihnen, dass die Garantie keine Teile abdeckt, die Verschleiß unterliegen oder schlecht werden können (Schmiermittel und verschiedene Flüssigkeiten, Zündkerzen, Kupplung, Filter, Kette, Kranz, Ritzel, Bremsbeläge, Bremsscheiben, Reifen, Leitungen und Teile aus Gummi, Batterie, Lampen und Sicherungen), keine Vorfälle durch Unerfahrenheit und/oder Nachlässigkeit und/oder durch Aussetzung gegenüber Witterungseinflüssen (Verbleichen des Lacks, Korrosion, usw...) und/oder durch Überschreitung der im Betriebshandbuch des Fahrzeugs vorgesehenen Höchstlast.

Es wird daran erinnert, dass diese Garantie gemäß Gesetzesvorschrift direkt von Ihrem „MV Agusta“-Vertragshändler geleistet wird, an den Sie sich bitte für alle Erfordernisse diesbezüglich wenden, und, auch im Ausland, bei jedem anderen Vertragshändler des „MV Agusta“-Netztes gilt.

## 2.2. NACH DEM WARTUNGSPLAN FÄLLIGE WARTUNG



### ACHTUNG

Wir weisen darauf hin, dass sich Ihr Vertragshändler, wenn an Ihrem Fahrzeug Schäden oder Betriebsstörungen auftreten, die auf die Nichtdurchführung der Wartungscoupons zurückzuführen sind, weigern kann, einen Eingriff im Rahmen der Garantie durchzuführen, und dass dieser Vertragshändler und MV Agusta S.p.A. auch nicht für eventuelle Schäden am Fahrzeug und/oder am Benutzer und/oder an dritten und/oder an Gegenständen von Dritten aufgrund der oben genannten Schäden oder Betriebsstörungen verantwortlich gemacht werden können.

Alle Wartungscoupons, einschließlich des ersten, sind kostenpflichtig, sowohl in Bezug auf das Material als auch auf die Arbeitskraft.

MV Agusta rät Ihnen, dass jeder Eingriff am Fahrzeug, egal ob es sich um Wartungscoupons



oder um jeglichen anderen Reparatur-, Einstellungs-, Austausch Eingriff oder eine andere Art von Eingriff handelt, bei Vertragswerkstätten der Vertragshändler von MV Agusta auf die im Wartungshandbuch, im Werkstatthandbuch und in eventuellen, von MV Agusta S.p.A. veröffentlichten technischen Rundschreiben beschriebene Art und Weise durchgeführt werden sollte, da MV Agusta die korrekte Durchführung jedes Eingriffs nur garantiert, wenn er bei Vertragswerkstätten der Vertragshändler von MV Agusta durchgeführt wird, die gemäß den Technik- und Verfahrensstandards von MV Agusta arbeiten und ausschließlich Originalersatzteile und -zubehör verwenden.

Nach jedem obligatorischen Wartungscoupon überprüfen Sie bitte immer, ob der entsprechende Coupon vom Vertragshändler abgestempelt und unterzeichnet wurde, und überprüfen Sie, ob der durchgeführte Eingriff Ihren Erwartungen entspricht. Sie finden die oben genannten Coupons am Ende des Garantiehefts.

Bewahren Sie das Garantieheft mit den vom MV Agusta-Vertragshändler abgestempelten Coupons und die jeweiligen Steuerbelege immer auf und übergeben sie es im Falle der Veräußerung des Fahrzeugs an den neuen Käufer.

## Fälligkeit der Wartungseingriffe nach dem Wartungsplan

Häufigkeit des Wartungsarbeiten km (mi)*	1000 (600)	Jedes Jahr	15000 (9000)	30000 (18000)	45000 (27000)	60000 (36000)	75000 (45000)	90000 (54000)	105000 (63000)
Coupon	A		B	C	D	E	F	G	H

(\*): Die Laufleistung-Coupons können zusammen mit der **obligatorischen** jährlichen Kupon durchgeführt werden



### 2.3. FAHRZEUGBELADUNG

Das Motorrad wurde zum Einsatz des Fahrers und höchstens eines Beifahrers entworfen.

Für einen sicheren Einsatz und unter Berücksichtigung der Straßenverkehrsvorschriften müssen die technische Gewichtswert, die hier unten angegeben ist, nie überschritten werden:

#### **BRUTALE 800 - RR**

Maximales technisch zulässiges Gesamtgewicht  
**379 kg**

Maximal transportierbare Masse  
**180 kg**

Die technisch zulässige Gesamtmasse ist die Summe der folgenden Massen:

- Motorradmasse;
- Fahrermasse;
- Beifahrermasse;
- Gepäckmasse und das der Zubehörteile.



#### **ACHTUNG**

Da das Gewicht einen enormen Einfluss auf die Lenkbarkeit, die Bremsleistung, die Fahrzeugeigenschaften und die Fahrzeugsicherheit hat, müssen die folgenden Vorschriften stets eingehalten werden.

- **DAS MOTORRAD NIE ÜBERLADEN!**  
Ein überladenes Motorrad kann die Reifen beschädigen, zu einem Kontrollverlust und schweren Unfällen führen. Überprüfen, dass das Gesamtgewicht mit Fahrer, Beifahrer, Gepäck und Zubehör das zulässige Fahrzeug-Gesamtgewicht nicht überschreitet.



### 3.1. Anbringung der Bedienelemente und Instrumente

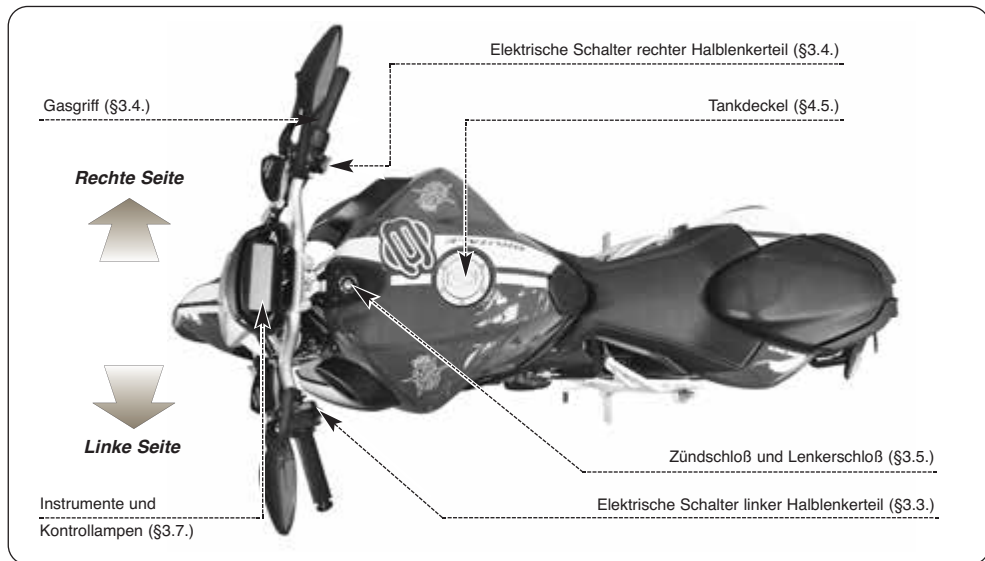

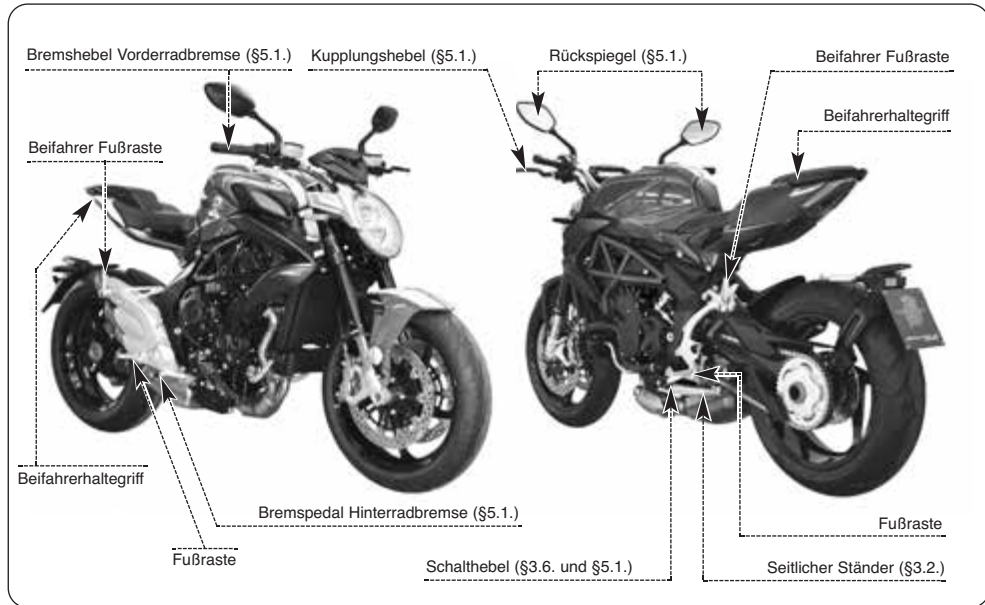



### 3.2. Seitlicher Ständer

Der Seitenständer ist mit einem Sicherheitsschalter (Startfreigabe) ausgerüstet, der ein Losfahren bei runtergeklapptem Seitenständer verhindert.

Ist der Motor bei runtergeklapptem Seitenständer angelassen worden und wird der Kupplungshebel gezogen, um zu Losfahren einen Gang einzulegen, wird die Stromversorgung zum Motor unterbrochen und der Motor stellt sich ab.

Ist der Seitenständer runtergeklappt und gleichzeitig ein Gang eingelegt, verhindert der Schutzschalter, dass der Motor gestartet werden kann. Auf diese Weise wird ein Umfallen des Motorrads vermieden.

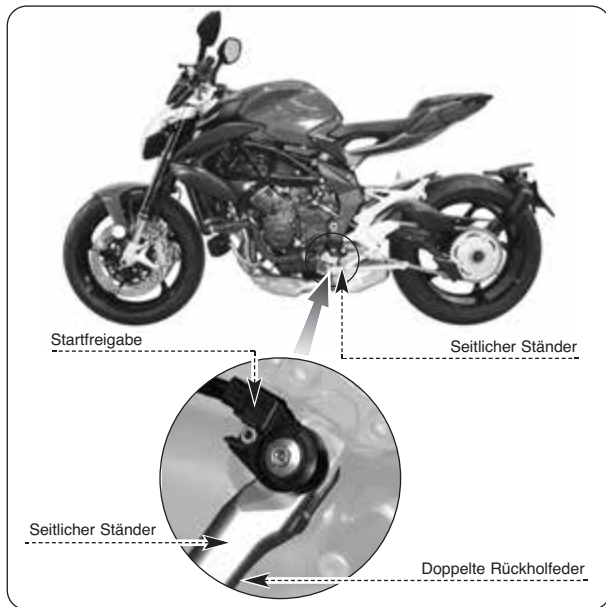



### 3.3. Linke Lenkerschalter

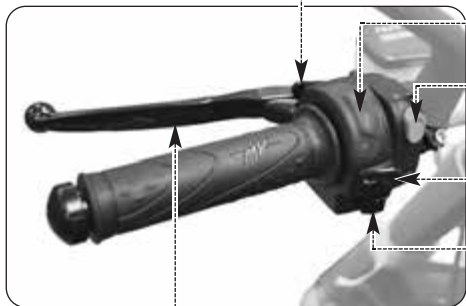

#### **Druckschalter Lichthupe**

Den Schalter mehrmals drücken.

#### **Druckschalter SET/OK**

Zum ändern der Funktionen am Armaturenbrett drücken (§ 4.4).

#### **Druckschalter Fernlicht/Fahrlicht**

Druckschalter hoch: ■ Fahrlicht 

Druckschalter tief: ■ Fernlicht 

#### **Hupenschalter**

Zur Betätigung der Hupe den Schalter drücken.

#### **Blinkerschalter**

Bei Verstellen des Hebels nach rechts oder links werden jeweils die rechten oder linken Blinker eingeschaltet. Der Hebel stellt sich auf Mittelstellung zurück. Zum Ausschalten der Blinker auf den Hebel drücken.

#### **Kupplungshebel**

Zur Betätigung der Kupplung den Kupplungshebel ziehen und wieder loslassen.



### Lichthupenschalter

Die Betätigung der Lichthupe durch den Lichthupenschalter dient dazu andere Verkehrsteilnehmer auf sich aufmerksam zu machen oder Gefahren zu signalisieren. Bei eingeschaltetem Fernlicht funktioniert die Lichthupe nicht.

### Druckschalter SET/OK

Der Schalter "SET" die Auswahl der verschiedenen Funktionen des Displays zur Durchführung von Einstellungen erlaubt, während der Schalter "OK" die Bestätigung der eingestellten Werte erlaubt.

### Druckschalter Fernlicht/ Abblendlicht

Schaltet sich normalerweise das Abblendlicht ein. Wenn es der Verkehr und die Straßenführung zulassen, kann mit diesem Druckschalter auf Fernlicht umgeschaltet werden.

### Blinkerschalter

Mit diesem Schalter kann anderen Verkehrsteilnehmern ein Fahrtrichtungs- oder Spurwechsel angezeigt werden.



**ACHTUNG: Das Nichtbetätigen oder die falsche Betätigung/ das Nichtausschalten des Blinkerschalters kann Unfälle verursachen. Die anderen Verkehrsteilnehmer können dadurch falsche Rückschlüsse auf die tatsächliche Fahrtrichtung ziehen. Vorm Abbiegen oder Spurwechsel stets die Blinker betätigen.**

### Hupenschalter

Die Betätigung der Hupe durch den Hupenschalter dient dazu andere Verkehrsteilnehmer auf sich aufmerksam zu machen oder Gefahren zu signalisieren.

### Kupplungshebel

Mit diesem Hebel wird die Kupplung ein- und ausgekuppelt.





## 3.4. Rechte Lenkerschalter

### **Warnblinkschalter**

Drücken, um die Warnblinkanlage einzuschalten oder abzuschalten.

### **Schalter "Engine Map"**

Drücken, um die Steuerung-Mapping zu bestimmen (§4.4.10.).

### **Schalter zum Abstellen des Motors**

Bei Betätigung wird der Motor abgestellt und kann nicht gestartet werden.

### **Druckschalter zum Anlassen des Motors**

Bei Betätigung wird der Motor gestartet. Sobald der Motor läuft muß der Schalter losgelassen werden.

### **Gasgriff**

Zum Gasgeben den Griff drehen.

### **Hebel Nachtfahrlicht / Tagfahrlicht (DRL) \***

Durch Verschiebung des Hebels nach oben bzw. unten wird das Nachtfahrlicht (Fernlicht/Abblendlicht) bzw. das Tagfahrlicht (Day Running Lights) aktiviert.

### **Bremshebel Vorderradbremse**

Zum Bremsen mit der Vorderradbremse den Bremshebel ziehen.

(\*): Ausgenommen Japan- und Australien-Versionen)

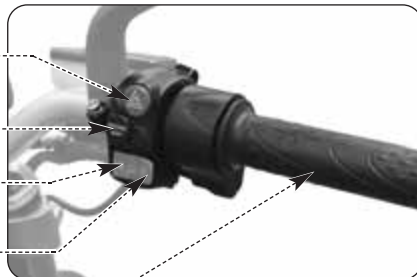



### Warnblinkschalter

Dient dazu andere Verkehrsteilnehmer auf sich aufmerksam zu machen oder Gefahren zu signalisieren.

### Schalter "Engine Map"

Dieser Schalter erlaubt die automatische Bestimmung der Steuerung-Mapping (siehe §4.4.10).

### Schalter zum Abstellen des Motors

Mit diesem Schalter kann der Motor abgestellt werden. Wird dieser Schalter betätigt, wird der Zündkreislauf unterbrochen, der Motor kann nicht gestartet werden. Soll der Motor neu gestartet werden, muss vorher dieser Schalter in Ausgangsstellung zurückgestellt werden.

### ANMERKUNG

**Unter normalen Bedingungen, dieses Schalter zum Abstellen des Motors verwenden.**

### Druckschalter zum Anlassen des Motors

Mit diesem Schalter wird der Motor gestartet. Bei laufendem Motor können über diesen Schalter die einzelnen Display-Funktionen ausgewählt werden.



**VORSICHT: Um Schäden an der elektrischen Anlage zu vermeiden, sollte dieser Schalter bei Startversuchen nie länger als 5 Sekunden gedrückt werden. Sprint der Motor nach einigen Startversuchen nicht an, siehe Kapitel "STÖRUNGEN" in der Wartungshandbuch.**

### Gasgriff

Mit dem Gasgriff wird die Benzinversorgung des Motors geregelt. Zum Gasgeben den Gasgriff aus Ruhestellung (Leerlaufstellung) drehen.



**ACHTUNG: Wenn Ihr Motorrad auf die Seite gefallen ist oder in einen Unfall verwickelt wurde, muss der Gasgriff vor einem erneuten Starten des Motorrads durch einen autorisierten MV Agusta Händler überprüft werden.**



### Hebel Nachtfahrlicht / Tagfahrlicht (DRL) \*

Diese Vorrichtung erlaubt die wechselweise Aktivierung des Tagfahrlichts (Day Running Lights) bzw. des Nachtfahrlichts (Fernlicht / Abblendlicht - siehe §3.3) in Abhängigkeit von den äußeren Lichtverhältnissen.

### Bremshebel der Vorderradbremse

Diese Steuerung ermöglicht die Einschaltung des Vorderrad-Bremssystems durch einen hydraulischen Kreislauf.

### ☐ Antiblockiersystem (ABS)

Die Brutale-Modelle sind mit einem Hilfskraft-Bremssystem ABS (Antiblockiersystem) ausgestattet, das verhindert das Blockieren der Räder während einer Notbremsung, daher garantiert die Stabilität des Fahrzeugs und verkürzt Bremswege.



**ACHTUNG:** Wenn das ABS-System aktiviert wird, könnte Vibrationen wahrnehmbar am Bremshebel oder Bremspedal. Wenn es auftritt, ist es empfehlenswert, halten die Bremshebel betätigt, um damit das Fahrzeug anzuhalten.



**ACHTUNG:** Wenn das ABS-System einen Fehler hat oder ausgeschaltet ist, so wird die entsprechende Kontrolllampe auf die Instrumentenausrüstung leuchtet (siehe § 3.7.1.). Von diesem Moment an, konnte das Antiblockiersystem nicht verfügbar sein wenn Sie bremsen. Wenn es einen Fehler in dem ABS-System, empfiehlt es sich, die Fahrt mit verminderter Geschwindigkeit fortgesetzt und einen autorisierten MV Agusta Kundendienst benachrichtigen. Wenn das ABS-System ausgeschaltet ist, folgen Sie den Aktivierungsverfahren in § 4.4.6. beschrieben.

*(\*): Ausgenommen Japan- und Australien-Versionen*



### 3.5. Zündschloß und Lenkerschloß



**ACHTUNG:** Keine Schlüsselanhänger oder anderes am Zündschlüssel anbringen, damit die Lenkerdrehung nicht eingeschränkt wird.



**ACHTUNG:** Den Zündschlüssel niemals während der Fahrt drehen, Sie könnten sonst die Kontrolle über das Fahrzeug verlieren.

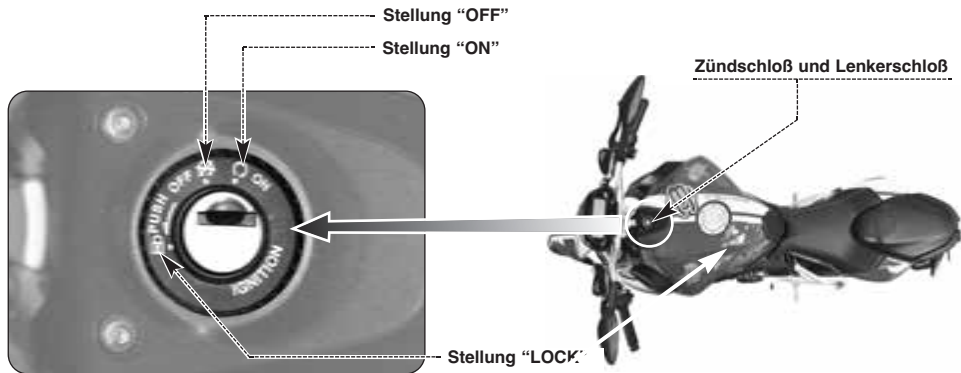



Über das Zündschloß werden der elektrische Kreislauf und das Lenkerschloß ein- bzw. ausgeschaltet. Es gibt folgende vier Stellungen für den Zündschlüssel.

### Stellung "OFF"

Alle elektrischen Stromkreise sind ausgeschaltet, der Zündschlüssel kann abgezogen werden.

### Stellung "ON"

Alle elektrischen Stromkreise sind eingeschaltet, die Instrumente und Kontrolllampen führen eine Autodiagnose durch, der Motor kann gestartet werden. Der Zündschlüssel kann nicht abgezogen werden.



**Vorsicht - Vorsichtsmaßnahme:** Die Nichteinhaltung der Anweisungen kann schwere und dauerhafte Schäden am Fahrzeug verursachen.



### Stellung "LOCK"

Den Lenker nach rechts oder links drehen. Den Schlüssel leicht drücken und auf Stellung "LOCK" drehen. Alle elektrischen Stromkreise sind ausgeschaltet, das Lenkerschloß ist eingearastet, der Zündschlüssel kann abgezogen werden.

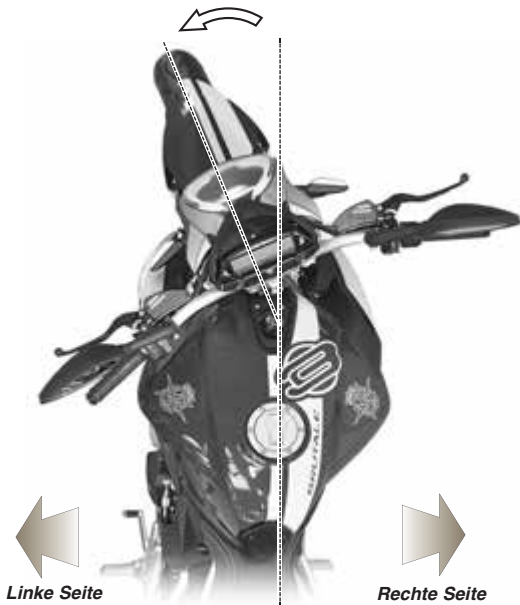



### 3.6. Schaltung

Die Stellung N "Neutral" ist die Leerlaufstellung, die auch durch Aufleuchten der entsprechenden Kontrolllampe am Armaturenbrett angezeigt wird.

Durch Drücken nach unten wird der erste Gang eingelegt. Durch Drücken nach oben wird der zweite Gang, durch weiteres Drücken der dritte Gang usw. bis zum sechsten Gang eingelegt.

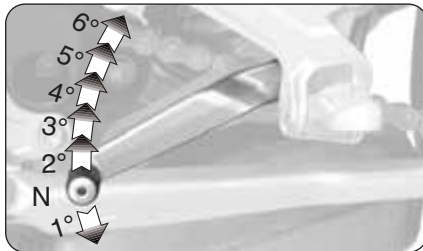

#### Funktion "Quick Shift"

Die Brutale-Modelle sind mit einem Gangwechsel-System/Schaltautomat ("Quick Shift") ausgestattet. Dieses System ermöglicht Ihnen in den nächst höheren oder niedrigeren Gang zu schalten, ohne die Kupplung zu ziehen oder die Gasgriffstellung zu verändern. Auf diese Weise ist es möglich, den nächst höheren oder niedrigeren Gang blitzschnell einzulegen und so den Beschleunigungsvorgang beizubehalten.



**ACHTUNG! Das "Quick Shift"-System arbeitet nicht:**

- wenn der Kupplungshebel gezogen wird;
- bei einer Geschwindigkeit von weniger als 30 km/h;
- wenn der Ganghebel nicht in der richtigen Ausgangsposition beim Gangwechsel.

Außerdem, wenn Sie das Motorrad in einem niedrigen Gang mit hohen Drehzahlen fahren und das Quick Shift System zum Hochschalten benutzen, kann das zu abrupten Reaktion führen, die die Stabilität des Fahrzeugs beeinträchtigen können. MV Agusta empfiehlt in all den oben genannten Fahrsituationen den Kupplungshebel zum Schalten zu benutzen, insbesondere dann, wenn die Motordrehzahl kurz vor dem Einsetzen des Drehzahlbegrenzers liegt.



### 3.7. Instrumente und Kontrolllampen

Die Instrumente und die Kontrolllampen schalten sich ein, wenn der Zündschlüssel auf "ON" gedreht wird. Nach einer Anfangskontrolle (ungefähr 7 Sekunden) entsprechen die Informationen dem allgemeinen Ist-Zustand des Motorrads.







### 3.7.1. Kontrolllampen

#### Kontrolllampe ABS (rot)

Leuchtet auf, wenn das ABS-System einen Fehler hat oder ausgeschaltet ist, oder wenn die Geschwindigkeit niedriger als 5 km/h beträgt.

**⚠ Gefahr - Achtung:** Wenn die Kontrolllampe leuchtet während der Fahrt, sofort anhalten und überprüfen Sie, dass das ABS-System eingeschaltet ist (siehe §4.4.6.). In diesem Fall, die Fahrt mit verminderter Geschwindigkeit fortgesetzt und einen autorisierten MV Agusta Kundendienst benachrichtigen.

#### Fernlichtkontrolle (blau)

Leuchtet auf, wenn das Fernlicht eingeschaltet ist.

#### Motorkontrollleuchte (gelb)

Schaltet sich ein, wenn eine Motorstörung auftritt.

#### Benzinreservekontrolle (orange)

Leuchtet auf, wenn im Tank noch ungefähr 4 Liter Kraftstoff enthalten sind.

#### Kontrolllampe Schaltung in Leerlauf (grün)

Leuchtet auf, wenn die Schaltung auf Leerlaufposition "Neutral" gestellt ist.

#### Kontrolle ausgeklappter Seitenständer (rot)

Leuchtet auf, wenn der Seitenständer ausgeklappt ist.

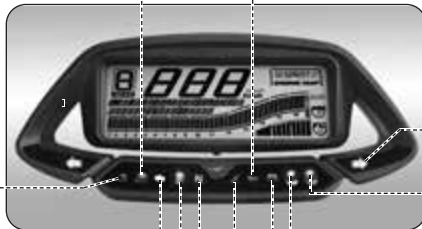

#### Motoröldruckkontrolle (rot)

Leuchtet auf, wenn der Öldruck unzureichend ist.

**⚠ Gefahr - Achtung:** Schaltet sie sich während der Fahrt ein, sofort anhalten und den Ölstand kontrollieren. Gegebenenfalls bei einem autorisierten MV Agusta Kundendienst nachfüllen lassen (siehe §3.8). Schaltet sie sich auch bei richtigem Ölstand ein, nicht weiterfahren und einen autorisierten MV Agusta Kundendienst benachrichtigen.

#### Blinkerkontrolle (grün)

Leuchtet auf, wenn die Blinker eingeschaltet sind.

#### Kontrollleuchten

#### Drehzahlbegrenzer (rot)

Leuchtet auf sich vor dem Eingriff des Drehzahlbegrenzers bei einer Drehzahl ein, die von der Übersetzung des aktivierten Getriebes abhängt. Der Begrenzer schreitet bei 13000 U/min ein.

#### Kontrollleuchte „Warning“ (orange)

Schaltet sich ein, wenn ein Defekt auftritt. Wenn die Zündung erfolgt während der Fahrt erhalten Sie bei Ihrem Kundendienst.

#### Batterie-Ladekontrolle (rot)

Leuchtet auf, wenn die Lichtmaschine nicht ausreichend Strom zum Laden der Batterie liefert. Schaltet sie sich während der Fahrt ein, wenden Sie sich bitte an einen autorisierten Kundendienst.



## 3.7.2. Multifunktions-Display

### Tachometer

Zeigt die Geschwindigkeit an. Der Wert kann im Kilometer pro Stunde (km/h) oder Meilen pro Stunden (Mph) angezeigt werden. Der Wert bei Vollausschlag ist 300 Km/h (186 Mph).

### Display welcher Gang

Zeigt an, welcher Gang aktuell eingelegt ist. Die Leerlaufposition wird durch die Ziffer "0" angezeigt.

### Gesamt-Kilometerzähler "TOTAL"

Zeigt den Gesamt-Kilometerstand an; von 0 bis 999999 (km oder mi)

### Teilstrecken-Kilometerzähler 1 "TRIP 1"

Zeigt den Teilstrecken-Kilometerstand an; von 0 bis 999.9 (km oder mi)

### Teilstrecken-Kilometerzähler 2 "TRIP 2"

Zeigt den Teilstrecken-Kilometerstand an; von 0 bis 999.9 (km oder mi)

### Chronometer / Zeitmesser

Zeigt die mit dem Chronometer gemessenen Zeiten an.

### Display ABS

Zeigt die Aktivierung des ABS-Funktion.

### Display Kontrollstufe des Antriebs

Zeigt die Kontrollstufe des gegenwärtig gewählten Antriebs an.

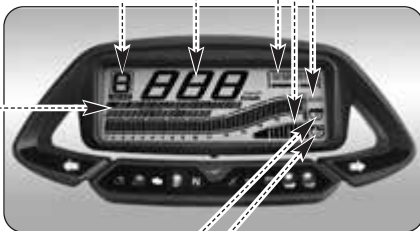

### Display Abbildung der Steuereinheit

Zeigt die Nummer der gegenwärtig gewählten Abbildung der Steuereinheit an.

**Uhr:** Zeigt die aktuelle Uhrzeit an.

### Thermometer

Zeigt die Kühlfüssigkeitstemperatur durch Einschalten unterschiedlich vieler Balken an einer Messskala an. Liegt die Temperatur außerhalb des normalen Betriebsbereiches, kann folgendes angezeigt werden:

- Am Display wird nur ein einziger, blinkender Balken angezeigt. Das ist die Anzeige für niedrige Temperatur.

- Alle Balken sind eingeschaltet, der oberste Balken blinkt. Das ist die Anzeige für hohe Temperatur.



**Gefahr – Achtung:** Bei hoher Temperatur das Fahrzeug anhalten und den Kühlfüssigkeitsstand kontrollieren. Muss nachgefüllt werden, wenden Sie sich bitte an einen autorisierten MV Agusta Kundendienst (siehe § 3.8). Erscheint die Anzeige auch bei richtigem Kühlfüssigkeitsstand, nicht weiterfahren und einen autorisierten MV Agusta Kundendienst benachrichtigen.



## 3.8. Schmiermitteltabelle

Beschreibung	Empfohlenes Produkt	Technische Angaben
Motoröl	Motul 7100 4T 5W40 (*)	SAE 5W/40
Kühlflüssigkeit	Motul Motocool Factory Line	Produkt mit Monoethylenglykol - Gebrauchsfertige - Kein Verdünnen mit Wasser
Brems- und Kupplungsflüssigkeit	Motul DOT 3 & 4 Brake Fluid	DOT4
Kettenöl	Motul Chain Lube Road	-

\* : Damit Sie die empfohlenen Produkte finden und kaufen können, empfiehlt Ihnen MV Agusta sich direkt an die autorisierten Vertragshändler zu wenden. Den Motor des Motorrads Brutale wurde mit dem Motoröl Motul 7100 4T 5W40 entwickelt. Steht das empfohlene Schmiermittel nicht zu Verfügung, rät MV Agusta zum Gebrauch vollständig synthetischer Öle, die die gleichen oder bessere Eigenschaften als folgende Normen haben:

- Konform API SN / SM
- Konform JASO MA2
- Konform SAE 5W40

### ANMERKUNG

Die o. a. Spezifizierungen müssen entweder allein oder zusammen mit anderen auf dem Behälter des Motoröl aufgedruckt sein.





#### 4.1. Einsatz des Motorrads

In diesem Abschnitt werden die wichtigsten Themen für einen richtigen Einsatz des Motorrads behandelt.



##### **ACHTUNG**

Das Motorrad Brutale zeigt hohe Leistungsmerkmale. Für sein Gebrauch wird ein ausreichendes Niveau des Wissens des Fahrzeugs angefordert. Wenn Sie dieses Motorrad zum ersten Mal benutzen, ist es notwendig, eine vorsichtige Haltung anzunehmen. Eine konkurrenzfähige Ridinghaltung kann die Gefahr der Unfälle erhöhen, welche die Sicherheit des Treibers und der Leute gefährden.



##### **ACHTUNG**

DIE BESCHRÄNKUNGEN FÜR DIE ERLAUBTE NUTZUNG DES FAHRZEUGES FINDEN SIE IM ABSCHNITT "SICHERHEITSINFORMATIONEN".



## 4.2. Einfahren



**Vorsicht - Vorsichtsmaßnahme: Die Nichteinhaltung der Anweisungen kann schwere und dauerhafte Schäden am Fahrzeug verursachen.**

Normalerweise denkt man beim Einfahren nur an den Motor. Tatsächlich muß die Einfahrzeit auch für andere wichtige Motorradteile berücksichtigt werden. Dies gilt besonders für die Reifen, die Bremsen, die Antriebskette usw. Die ersten Kilometer müssen besonders langsam und ruhig gefahren werden.

### Von 0 bis 500 km (von 0 bis 300 mile) (A)

In dieser ersten Einfahrphase sollte die Motordrehzahl häufig geändert werden. Möglichst auf leicht hügeligen und kurvenreichen Strecken fahren und lange grade Strecken vermeiden.



### ACHTUNG

Neue Reifen müssen auf geeignete Weise eingefahren werden, so dass sie ihre komplette Effizienz erhalten. Während der ersten 100 km sollte ein Anfahren bei Vollgas, schnelle Kurvenfahrten und Vollbremsungen vermieden werden. Wird der Einfahrzeitraum nicht beachtet, besteht Schleuder- oder Unfallgefahr, weil die Kontrolle über das Fahrzeug verloren gehen kann.



❑ **Von 500 bis 1000 km (von 300 bis 600 mile)**

In dieser Phase Vollgas vermeiden und nie über lange Strecken mit konstanter Geschwindigkeit fahren.



❑ **Von 1000 bis 2500 km (von 600 bis 1600 mile)**

Das Motorrad kann jetzt stärker beansprucht werden. Trotzdem sollte die angegebene Motordrehzahl nicht überschritten werden.





#### 4.3. Starten des Motors



**ACHTUNG:** Das Fahrzeug in geschlossenen Räumen laufen zu lassen ist gefährlich. Die Abgase enthalten Kohlenmonoxid, ein farbloses und geruchloses Gas, das tödlich sein oder zu schweren Unfällen führen kann. Den Motor nur Außen, in der freien Luft laufen lassen.

► Wird der Zündschalter auf "ON" gedreht, wird von den Instrumenten und den Kontrolllampen eine Autodiagnose ausgeführt. Während dieser Phase sollte geprüft werden, dass sich alle Kontrolllampen am Armaturenbrett einschalten.

► Damit das System für die Zündkreis-Unterbrechung die Startfreigabe gibt, muss eine der folgenden Bedingungen erfüllt sein:

- Die Schaltung ist auf Leerlaufposition und der Kupplungshebel ist gezogen.
- Bei der Schaltung ist ein Gang eingelegt, der Kupplungshebel ist gezogen und der Seitenständer hochgeklappt.

**HINWEIS:** Wenn bis zum nächsten programmierten Wartungseingriff weniger als 1000 km fehlen, erscheint auf dem Display die nebenstehend dargestellte Bildschirmseite.





► Wenn die Autodiagnose erkennt eine Störung am Fahrzeug, das Display zeigt die Warnung in der gezeigten Bild. Insbesondere das Display zeigt die Teil des Motorrads, auf denen das Störung festgestellt wurde.



► Die Taste "OK" drücken, bis die Funktion "RUN" angezeigt wird.

**ACHTUNG**

Wird ein Störung am Fahrzeug erkannt wird, nicht den Motor starten und einen autorisierten MV Agusta Kundendienst benachrichtigen.







#### ❑ Starten des motors

- ▶ Den Anlasserschalter drücken, ohne den Gasgriff zu drehen.
- ▶ Sobald der Motor gestartet ist, den Anlasserschalter loslassen.



#### Vorsicht – Vorsichtsmaßnahme:

- Um Schäden an der elektrischen Anlage zu vermeiden, den Anlasserschalter nicht länger als 5 Sekunden gedrückt halten.
  - Den Motor nicht über längere Zeit bei stehendem Motorrad laufen lassen. Die daraus folgende Überhitzung kann interne Motor-Bauteile beschädigen.
- Der Motor sollte bei langsamer Fahrt auf Betriebstemperatur gebracht werden.
- Um die Haltbarkeit des Motors zu verlängern, bei kaltem Motor kein Vollgas geben.

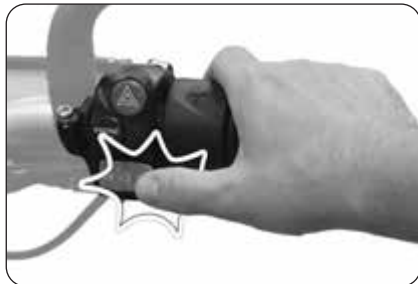



#### 4.4. Auswahl und Einstellung der Display-Funktionen

Einige der wichtigsten Parameter und Anzeigen können eingestellt werden.

Folgende Funktionen sind einstellbar:

- Auswahl des Betriebsmodus:
  - “RUN” (Kilometerzähler)
  - “SPEED LIMITER” (Geschwindigkeitsbegrenzer)
  - “TC” (Traktionskontrolle)
  - “CHRONO” (Zeitmesser)
  - “ABS” (Antiblockiersystem)
  - “QUICK SHIFT”
  - “CLOCK” (Uhr)
- Reset Tageskilometerzähler:

Tageskilometerzähler 1	“TRIP 1”
Tageskilometerzähler 2	“TRIP 2”
- Aktivieren des Zeitmessers
- Einstellung der Uhr
- “IMMOBILIZER” (Anlage Diebstahlsicherung)
- Mappingauswahl





#### 4.4.1. Auswahl der Displayfunktionen

Folgende Funktion können auf dem Display eingestellt werden:

- "RUN" (Kilometerzähler)
- "SPEED LIMITER" (Geschwindigkeitsbegrenzer)
- "TC" (Traktionskontrolle)
- "CHRONO" (Zeitmesser)
- "ABS" (Antiblockiersystem)
- "QUICK SHIFT"
- "CLOCK" (Uhr)

Die Anzeige der einzelnen Funktionen erfolgt durch Druck auf die Taste "SET" für weniger als 3 Sekunden. Bei Betätigung der Taste werden die Funktionen zyklisch am Display angezeigt. Die gewünschte Funktion auswählen.



#### ACHTUNG:

Änderungen oder Einstellungen an den Displayfunktionen müssen bei ausgeschaltetem Motor, Schaltung in Leerlauf, angehaltenem Motorrad und Füßen auf dem Boden ausgeführt werden. Eine Änderung der Displayeinstellungen während der Fahrt ist verboten, sofern nicht anders angegeben.



### ❑ Betriebsmodus "RUN"

Zusätzlich zur Tachometerfunktion werden im Display folgende Funktionen angezeigt (siehe §4.4.2.):

- Gesamtkilometerzähler "TOTAL"
- Tageskilometerzähler 1 "TRIP 1"

Alternativ:

- Gesamtkilometerzähler "TOTAL"
- Tageskilometerzähler 2 "TRIP 2"

### ❑ Betriebsmodus "SPEED LIMITER"

Mit dieser Funktion kann die Höchstgeschwindigkeit des Motorrades begrenzt werden (siehe §4.4.3.).





#### ❑ Betriebsmodus "TC"

Mit dieser Funktion kann die Motor-Traktionskontrolle an die eigenen Bedürfnisse angepasst werden (siehe §4.4.4.).



#### ❑ Betriebsmodus "CHRONO"

Mit diesem Betriebsmodus kann die Chronometerfunktion sowie das Speichern der Messdaten eingeschaltet werden (siehe §4.4.5.). Folgende Funktionen werden angezeigt:

- |                               |               |
|-------------------------------|---------------|
| • Zeitmesser Aktuelle Runde   | "CURRENT LAP" |
| • Zeitmesser Schnellste Runde | "BEST LAP"    |
| • Zeitmesser Letzte Runde     | "LAST LAP"    |
| • Rundenzähler                | "N° LAP"      |





#### ❑ Betriebsmodus "ABS"

Mit diesem Betriebsmodus, kann das Antiblockiersystem (ABS) aktiviert oder deaktiviert werden (siehe §4.4.6.).



#### ❑ Betriebsmodus "QUICK SHIFT"

Diese Menüfunktion erlaubt Ihnen die Aktivierung bzw. Deaktivierung der Quick Shifter Funktion (siehe § 4.4.7.).





#### Betriebsmodus“CLOCK”

Mit dieser Funktion können Sie die Uhr einstellen (Stunden und Minuten) (siehe §4.4.8.).





#### 4.4.2. Nullstellen der Funktionen des Teilstrecken-Kilometerzählers

Die Werte der Funktionen "TRIP 1" und "TRIP 2" können wie folgt auf Null zurückgestellt werden:



#### ACHTUNG

Änderungen oder Einstellungen an den Displayfunktionen müssen bei ausgeschaltetem Motor, Schaltung in Leerlauf, angehaltenem Motorrad und Füßen auf dem Boden ausgeführt werden. Eine Änderung der Displayeinstellungen während der Fahrt ist verboten.

► Den Modus "RUN" öffnen. Auf der Startseite werden die Funktionen Gesamt-Kilometerzähler ("TOTAL") und Teilstrecken-Kilometerzähler 1 ("TRIP 1") angezeigt.

► Wird jetzt die Taste "OK" länger als drei Sekunden gedrückt gehalten, wird der Wert für "TRIP 1" auf Null gestellt.







► Die Taste "OK" kürzer als 3 Sekunden drücken, bis die Funktion Teilstrecken-Kilometerzähler 2 ("TRIP 2") angezeigt wird.



► Wird jetzt die Taste "OK" länger als 3 Sekunden gedrückt gehalten, wird der Wert für "TRIP 2" auf Null gestellt.





#### 4.4.3. Betriebsmodus "SPEED LIMITER"

Beim Starten des Motors ist die "SPEED LIMITER" Funktion deaktiviert. Um sie zu aktivieren müssen Sie folgende Schritte durchführen:

- ▶ Drücken Sie die Taste "SET" am linken Lenkerschalter bis der Betriebsmodus "SPEED LIMITER" erscheint. Die eingestellte Höchstgeschwindigkeit wird angezeigt (entspricht der aktuellen Geschwindigkeit des Fahrzeugs) und beginnt zu blinken.

#### ANMERKUNG

Die maximale Höchstgeschwindigkeit kann während der Fahrt eingestellt oder geändert werden.

- ▶ Drücken Sie "SET" für weniger als drei Sekunden: die maximale Geschwindigkeit wird um **2 km/h** verringert. Wenn Sie "OK" für weniger als drei Sekunden drücken wird die maximale Geschwindigkeit um **2 km/h** erhöht.





► Drücken Sie "OK" für mehr als drei Sekunden um die eingestellte Höchstgeschwindigkeit zu bestätigen. Die Anzeige hört auf zu blinken und schaltet in den "RUN" Betriebsmodus zurück.

► Wenn Sie stattdessen "SET" für mehr als drei Sekunden drücken ist die Funktion "SPEED LIMITER" deaktiviert und es wird "OFF" angezeigt. Nach drei Sekunden schaltet das Display in den "RUN" Betriebsmodus zurück.

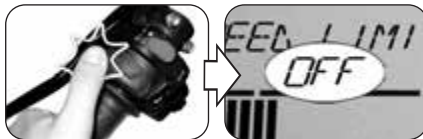

► Wenn die "SPEED LIMITER" Funktion aktiviert ist beginnt die Geschwindigkeitsanzeige zu blinken wenn die eingestellte Höchstgeschwindigkeit erreicht ist.





#### 4.4.4. Betriebsmodus "TC"

► Drücken Sie mehrfach die Taste "SET" am linken Lenkerschalter bis der Betriebsmodus "TC" erscheint. Die momentan eingestellte Stufe der Traktionskontrolle wird angezeigt.

##### ANMERKUNG

**Die Stufe der Traktionskontrolle kann während der Fahrt eingestellt oder geändert werden.**

► Drücken Sie "OK" für weniger als drei Sekunden um die Traktionskontrolle um eine Stufe zu erhöhen. Wenn Sie stattdessen "SET" für weniger als drei Sekunden drücken verringern Sie die Traktionskontrolle um eine Stufe. Dieser Wert kann zwischen "0" und "8" eingestellt werden.

"0" = sehr später Eingriff der Traktionskontrolle

"8" = früher Eingriff der Traktionskontrolle

Alle Stufen zwischen "0" und "8" sind Abstufungen der beiden Werte.

► Drücken Sie "SET" für mehr als drei Sekunden um die ausgewählte Stufe der Traktionskontrolle zu bestätigen.



4 DE



#### 4.4.5. Zeitmessung

##### □ Rundenzeitenerfassung

► Nachdem die Chronometer-Funktion eingeschaltet worden ist (Betriebsmodus "CHRONO"), kann mit der Datenerfassung bezüglich der Rundenzeiten begonnen werden.

► Bei Betätigung der Lichthupentaste wird mit der Datenmessung begonnen. Die kleinen Punkte, mit denen die Minutenanzeige von der Sekundenanzeige und von den Zehntel Sekunden getrennt ist, fangen an zu blinken. Das Instrument fängt an die Zeiten zu erfassen.

##### ANMERKUNG

Wenn die Funktion "CHRONO" aktiviert ist wird durch die erste Betätigung der Lichthupe die Funktion Traktionskontrolle eingeschaltet. Ab jetzt ist es möglich die Stufe der Traktionskontrolle durch die Tasten "SET" und "OK" zu verändern (siehe §4.4.4.).





► Bei erneutem Druck auf die Lichthupentaste wird die Messzeit zur ersten gefahrenen Runde registriert. Gleichzeitig beginnt das Instrument mit der Erfassung der zweiten Rundenzeit.

Die Messzeit zur ersten gefahrenen Runde wird im Speicher gespeichert und bleibt für 10 Sekunden am Display angezeigt, anschließend wird die Zeit für die nächste Runde angezeigt.

► Wird das Chronometer weiter benutzt, wird bei jeder Betätigung der Lichthupentaste eine Zeit registriert. Mit dem Instrument können maximal bis zu 100 aufeinander folgende Daten gespeichert werden.

Während der Zeitanzeige zur eben beendeten Runde erscheint am Display das Symbol “+” oder “-”, je nachdem, ob die gemessene Zeit länger oder kürzer als die vorherige Rundenzeit war.





## ☐ Anzeige der Daten

Nach der Erfassung der Zeiten können die Daten angezeigt werden.

► Den Modus "CHRONO" öffnen. Auf dieser Seite werden die schnellste Rundenzeit ("BEST LAP") sowie die letzte Rundenzeit ("LAST LAP") angezeigt.



## ACHTUNG

Änderungen oder Einstellungen an den Displayfunktionen müssen bei ausgeschaltetem Motor, Schaltung in Leerlauf, angehaltenem Motorrad und Füßen auf dem Boden ausgeführt werden. Eine Änderung der Displayeinstellungen während der Fahrt ist verboten.

► Die Taste "OK" kürzer als 3 Sekunden drücken, bis "LAPS VIEW" angezeigt wird





► Durch wiederholten Druck auf die Lichthupentaste können nacheinander alle vorher erfassten Zeiten ab der letzten gespeicherten Runde angezeigt werden.

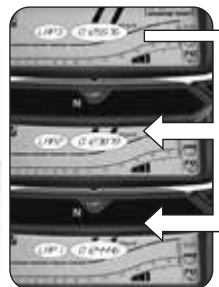

► Am Ende der Datenanzeige kann durch Druck auf die Taste "SET" wieder auf den Betriebsmodus "LAPS VIEW" zurückgestellt und auf den nächsten Modus umgestellt werden.







## ❑ Löschen der Daten

Die gespeicherten Daten können wie folgt gelöscht werden:



### ACHTUNG

Änderungen oder Einstellungen an den Displayfunktionen müssen bei ausgeschaltetem Motor, Schaltung in Leerlauf, angehaltenem Motorrad und Füßen auf dem Boden ausgeführt werden. Eine Änderung der Displayeinstellungen während der Fahrt ist verboten.

► *Löschen einzelner Zeiten:* Den Betriebsmodus "CHRONO" öffnen und die Taste "SET" kürzer als drei Sekunden drücken, bis "SINGLE LAP RESET" angezeigt wird.

► Die Taste "OK" kürzer als drei Sekunden drücken. Der Wert für die letzte Zeit der gespeicherten Runde fängt an zu blinken.





► Wird jetzt die Taste "OK" länger als drei Sekunden gedrückt gehalten, wird der Wert gelöscht.  
Wird hingegen die Taste "SET" kürzer als drei Sekunden gedrückt gehalten, wird das Löschverfahren abgebrochen.

► Anschließend können, durch Druck auf die Lichthupentaste mit folgendem Druck auf die Taste "OK" für länger als drei Sekunden, nacheinander alle vorher gemessenen Zeiten gelöscht werden.

► Nach dem Löschen der Daten kann durch Druck auf die Taste "SET" wieder auf den Betriebsmodus "SINGLE LAP RESET" zurückgestellt und auf den nächsten Modus umgestellt werden

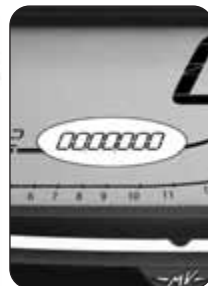



► *Löschen der besten Zeit:* Den Betriebsmodus "CHRONO" öffnen und die Taste "SET" kürzer als drei Sekunden drücken, bis "BEST LAP RESET" angezeigt wird.



► Die Taste "OK" kürzer als drei Sekunden drücken. Der Wert für die beste Rundenzeit fängt an zu blinken.





► Wird jetzt die Taste "OK" länger als drei Sekunden gedrückt gehalten, wird der Wert gelöscht. Wird hingegen die Taste "SET" kürzer als drei Sekunden gedrückt gehalten, wird das Löschverfahren abgebrochen.

► Nach dem Löschen der Daten kann durch Druck auf die Taste "SET" der Betriebsmodus "BEST LAP RESET" beendet und auf den nächsten Modus umgestellt werden.

► *Löschen aller gespeicherten Zeiten:* Den Betriebsmodus "CHRONO" öffnen und die Taste "SET" kürzer als drei Sekunden drücken, bis "ALL LAPS RESET" angezeigt wird.

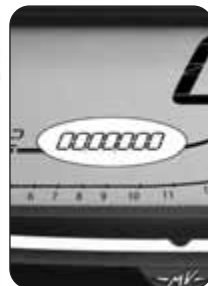



► Die Taste "OK" kürzer als drei Sekunden drücken. Am Display wird zur Eingabe einer Bestätigung aufgefordert, dass alle im Speicher befindlichen Daten gelöscht werden sollen.



► Wird jetzt die Taste "OK" länger als drei Sekunden gedrückt gehalten, werden alle vorher gespeicherten Zeiten gelöscht. Wird hingegen die Taste "SET" kürzer als drei Sekunden gedrückt gehalten, wird das Lösungsverfahren abgebrochen.



► Nach dem Löschen der Daten kann durch Druck auf die Taste "SET" der Betriebsmodus "ALL LAPS RESET" beendet und auf den Modus "CHRONO" zurückgestellt werden.



#### 4.4.6. Auswahl der ABS-Funktionen

► Die Taste “SET” drücken, bis den Betriebsmodus “ABS” öffnen; “SETTING ABS” auf dem Display erscheint.



#### **ACHTUNG**

Änderungen oder Einstellungen an den Displayfunktionen müssen bei ausgeschaltetem Motor, Schaltung in Leerlauf, angehaltenem Motorrad und Füßen auf dem Boden ausgeführt werden. Eine Änderung der Displayeinstellungen während der Fahrt ist verboten.

► Wird die Taste “OK” weniger als drei Sekunden gedrückt, “ABS ON” blinkt auf dem Display.

► Wenn keine Taste gedrückt wird, nach drei Sekunden wird die Auswahl “ABS ON” bestätigt. Unter dieser Bedingung das ABS-System eingeschaltet wird. Die Taste “SET” drücken, um die Betriebsmodus “ABS” zu verlassen.





- ▶ Stattdessen, wenn Sie die Taste "OK" drücken, während die Beschriftung immer noch blinkt, dann "ABS OFF" auf dem Display erscheint.
- ▶ Wenn keine Taste gedrückt wird, nach drei Sekunden wird die Auswahl "ABS OFF" bestätigt. Unter dieser Bedingung das ABS-System abgeschaltet wird. Die Taste "SET" drücken, um die Betriebsmodus "ABS" zu verlassen.



DE 4

**ACHTUNG**

Wenn das ABS-System ausgeschaltet ist, so wird die entsprechende Kontrolllampe auf die Instrumentenausrüstung leuchtet (siehe § 3.7.1.). Von diesem Moment an, das Antiblockiersystem ist nicht verfügbar wenn Sie bremsen. Einen vorsichtigen Fahrweise adoptieren und bei niedriger Geschwindigkeit fahren, um die Steuerung des Fahrzeuges zu halten bei einer Notbremsung.



#### 4.4.7. Betriebsmodus "QUICK SHIFT"

► Drücken Sie mehrfach die Taste "SET" am linken Lenkerschalter bis der Betriebsmodus "QUICK SHIFT" erscheint. Die aktuelle Einstellung wird im Display angezeigt.



**ACHTUNG:** Änderungen oder Einstellungen an den Displayfunktionen müssen bei ausgeschaltetem Motor, Schaltung in Leerlauf, angehaltenem Motorrad und Füßen auf dem Boden ausgeführt werden. Eine Änderung der Displayeinstellungen während der Fahrt ist verboten.

- Drücken Sie "OK" für weniger als drei Sekunden und die aktuelle Einstellung beginnt zu blinken.
- Drücken Sie "OK" für weniger als drei Sekunden und die Einstellung schaltet von "OFF" zu "ON" und umgekehrt.
- Drücken Sie "SET" um die Einstellung der "QUICK Shift" Funktion zu bestätigen.







#### 4.4.8. Einstellung der Uhr

► Zur Einstellung der Uhrzeit die Taste “SET” drücken, bis die Schrift “CLOCK SETTING” erscheint.



#### ACHTUNG

Änderungen oder Einstellungen an den Displayfunktionen müssen bei ausgeschaltetem Motor, Schaltung in Leerlauf, angehaltenem Motorrad und Füßen auf dem Boden ausgeführt werden. Eine Änderung der Displayeinstellungen während der Fahrt ist verboten.

► Die Taste “OK” für weniger als drei Sekunden drücken; die Stunden-Ziffer beginnt zu blinken.

► Indem die Taste “OK” erneut für weniger als drei Sekunden gedrückt wird, steigt die Stunden-Ziffer bis zum nächsten Wert.

► Die Taste “OK” länger als drei Sekunden drücken; die ausgewählte Stunden-Ziffer wird bestätigt. Sollte stattdessen die Taste “SET” für weniger als drei Sekunden gedrückt werden, wird die Einstellung unterbrochen.

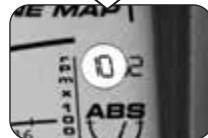
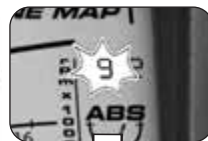



- ▶ Nachdem die Stunden-Ziffer eingestellt wurde, geht das Armaturenbrett automatisch zur Einstellung der Minuten-Ziffer über. Die Minuten-Ziffer beginnt zu blinken.
- ▶ Indem die Taste "OK" für weniger als drei Sekunden gedrückt wird, steigt die Minuten-Ziffer bis zum nächsten Wert.
- ▶ Die Taste "OK" länger als drei Sekunden drücken; die ausgewählte Minuten-Ziffer wird bestätigt, und das Armaturenbrett kehrt in den "CLOCK"-Modus zurück. Sollte stattdessen die Taste "SET" für weniger als drei Sekunden gedrückt werden, wird die Einstellung unterbrochen.





#### 4.4.9. Betriebsmodus "IMMOBILIZER"

Die Funktion "IMMOBILIZER" (Wegfahrsperrung) ermöglicht ein Starten des Motors nur, nachdem der Original-Zündschlüssel erkannt worden ist. Es handelt sich um eine, in den elektronischen Schaltkreis des Fahrzeugs integrierte, Diebstahlsicherung, die allen nicht autorisierten Personen die Nutzung des Fahrzeugs verwehrt. Der Betriebsmodus "IMMOBILIZER" am Armaturenbrett darf nur bei Störungen benutzt werden. Sollte der Originalschlüssel aus irgend einem Grund nicht von der Anlage erkannt werden, um die Motor-Startfreigabe zu erhalten, muss der Geheimcode eingegeben werden, der auf der MV Code Card angegeben ist, die zusammen mit dem Fahrzeug übergeben wurde.

- ▶ Die Abdeckung vom Textkasten auf der Rückseite der MV Code Card entfernen und den elektronischen Geheimcode für den Zündschlüssel ablesen (in der Abbildung ist ein reiner Beispielwert für den Code angegeben).
- ▶ Den Betriebsmodus "RUN" öffnen und die Taste "SET" länger als 10 Sekunden drücken, bis "IMMOBILIZER" angezeigt wird.



**ACHTUNG**

Änderungen oder Einstellungen an den Displayfunktionen müssen bei ausgeschaltetem Motor, Schaltung in Leerlauf, angehaltenem Motorrad und Füßen auf dem Boden ausgeführt werden. Eine Änderung der Displayeinstellungen während der Fahrt ist verboten.

- ▶ Die Taste "OK" kürzer als 3 Sekunden drücken, um die erste Ziffer des Code einzugeben.
- ▶ Wird die Taste "OK" kürzer als 3 Sekunden gedrückt, kann der Wert für die erste Ziffer zwischen **0** und **9** eingestellt werden.
- ▶ Ist die gewählte Ziffer richtig eingestellt worden, die Taste "OK" länger als 3 Sekunden gedrückt halten. Auf diese Weise wird die erste Ziffer des Code bestätigt. Jetzt kann die zweite Ziffer des Code eingegeben werden.
- ▶ Auf die gleiche Weise wie bei der ersten Ziffer können auch die restlichen drei Ziffern eingegeben werden.

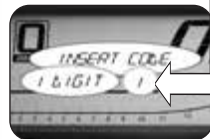



► Nach Abschluss des Verfahrens für die Code-Eingabe erscheint am Display die Meldung "CONFIRM CODE". Die Taste "OK" länger als 3 Sekunden gedrückt halten, um den eingegebenen Code zu bestätigen.



► Wird der eingegebene Code richtig vom System erkannt, erscheint die Meldung "VALID CODE". Das Armaturenbrett-Display stellt sich auf die Betriebsmodalität "RUN" zurück. Der Motor kann gestartet werden.

► Ist ein falscher Code eingegeben worden, erscheint die Meldung "NOT VALID CODE". Das System gibt keine Starfreigabe für den Motor. Das Armaturenbrett-Display stellt sich auf die Betriebsmodalität "IMMOBILIZER" zurück. Das Verfahren für die Code-Eingabe von Anfang an wiederholen. Darauf achten, dass alle auf der MV Code Card angegebenen Ziffern richtig eingegeben werden. Sollten weitere Probleme auftreten, bitte einen autorisierten MV Agusta Kundendienst benachrichtigen.





#### 4.4.10. Auswahl Mapping Motorsteuerung

Bei den Modellen Brutale ist es möglich unterschiedliche Mappings der Motorsteuerung auszuwählen, um die Fahreigenschaften des Motorrads den jeweiligen Fahrsituationen anzupassen.

##### ANMERKUNG

**Auswahl der Mapping kann während der Fahrt eingestellt oder geändert werden.**

Das Mapping kann durch Drücken der Taste auf der rechten Seite des Lenkers umgeschaltet werden. Die unterschiedlichen Mappings werden in der unten aufgeführten Reihenfolge nacheinander aufgerufen.

Mapping	N	R	S	C
Modus	Normal	Regen	Sport	Individuell





### ❑ Einstellen des individuellen Mappings

- ▶ Drücken Sie der Taste “ENGINE MAP” bis Mapping “C” im Display angezeigt wird.



#### **ACHTUNG!**

Änderungen oder Einstellungen an dem individuellen Mapping müssen im Leerlauf bei stehendem Motorrad und Füßen auf dem Boden ausgeführt werden. Ändern Sie das Mapping nicht während der Fahrt.

- ▶ Drücken Sie “SET” bis “SETTING CUSTOM MAP” erscheint.

Um die individuellen Parameter an Ihre Bedürfnisse anzupassen führen Sie bitte folgende Schritte durch.

**ANMERKUNG:** Die individuelle Mapping kann durch Mischen der Eigenschaften der Mappings “Normal”, “Regen” und “Sport” erstellt werden, wenn die folgenden Parameter definiert sind.

- ▶ *Sensibilität Gasgriff:* Drücken Sie “OK” für weniger als drei Sekunden bis “GAS SENSITIVITY” angezeigt wird.





► Drücken Sie “SET” für weniger als drei Sekunden.  
Die aktuelle Einstellung der Sensibilität des Gasgriffs  
wird im Display angezeigt.



► Drücken Sie “OK” für weniger als drei Sekunden und  
die Anzeige beginnt zu blinken.

► Durch wiederholtes Drücken der Taste “OK” werden  
die folgenden Einstellmöglichkeiten nacheinander  
angezeigt:

- “NORMAL” (Normal)
- “RAIN” (Regen)
- “SPORT” (Sport)

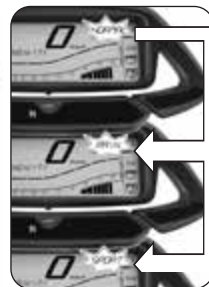





► Drücken Sie "OK" für mehr als drei Sekunden um die gewählte Einstellung zu bestätigen. Die Anzeige hört auf zu blinken und schaltet nach ein paar Sekunden zurück zu "GAS SENSITIVITY". Jetzt kann mit der Einstellung der nächsten Parameter fortgefahren werden.



► *Maximales Drehmoment*: Drücken Sie "OK" für weniger als drei Sekunden bis "MAX ENGINE TORQUE" angezeigt wird.





► Drücken Sie “SET” für weniger als drei Sekunden.  
Die aktuelle Einstellung des maximalen Drehmoments  
wird im Display angezeigt.



► Drücken Sie “OK” für weniger als drei Sekunden und  
die Anzeige beginnt zu blinken.

► Durch wiederholtes Drücken der Taste “OK” werden  
die folgenden Einstellmöglichkeiten nacheinander  
angezeigt:

- “RAIN” (Regen)
- “SPORT” (Sport)





► Drücken Sie "OK" für mehr als drei Sekunden um die gewählte Einstellung zu bestätigen. Die Anzeige hört auf zu blinken und schaltet nach ein paar Sekunden zurück zu "MAX ENGINE TORQUE".



► *Motorbremse*: Drücken Sie "OK" für weniger als drei Sekunden bis "ENGINE BRAKE" angezeigt wird.





► Drücken Sie "SET" für weniger als drei Sekunden.  
Die aktuelle Einstellung der Motorbremse wird im Display angezeigt.



► Drücken Sie "OK" für weniger als drei Sekunden und die Anzeige beginnt zu blinken.

► Durch wiederholtes Drücken der Taste "OK" werden die folgenden Einstellmöglichkeiten nacheinander angezeigt:

- "NORMAL" (Normal)
- "SPORT" (Sport)





► Drücken Sie "OK" für mehr als drei Sekunden um die gewählte Einstellung zu bestätigen. Die Anzeige hört auf zu blinken und schaltet nach ein paar Sekunden zurück zu "ENGINE BRAKE".



► *Ansprechverhalten des Motors:* Drücken Sie "OK" für weniger als drei Sekunden bis "ENGINE RESPONSE" angezeigt wird.





► Drücken Sie “SET” für weniger als drei Sekunden.  
Die aktuelle Einstellung des Ansprechverhaltens des Motors wird im Display angezeigt.



► Drücken Sie “OK” für weniger als drei Sekunden und die Anzeige beginnt zu blinken.

► Durch wiederholtes Drücken der Taste “OK” werden die folgenden Einstellmöglichkeiten nacheinander angezeigt:

- “SLOW” (Langsame Ansprechverhalten des Motors)
- “FAST” (Schnelle Ansprechverhalten des Motors)





► Drücken Sie "OK" für mehr als drei Sekunden um die gewählte Einstellung zu bestätigen. Die Anzeige hört auf zu blinken und schaltet nach ein paar Sekunden zurück zu "ENGINE RESPONSE".

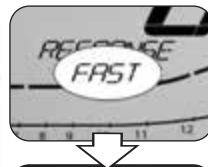

► *Drehzahlbegrenzer:* Drücken Sie "OK" für weniger als drei Sekunden bis "RPM LIMITER" angezeigt wird.





► Drücken Sie “SET” für weniger als drei Sekunden.  
Die aktuelle Einstellung des Drehzahlbegrenzers wird  
im Display angezeigt.



► Drücken Sie “OK” für weniger als drei Sekunden und  
die Anzeige beginnt zu blinken.

► Durch wiederholtes Drücken der Taste “OK” werden  
die folgenden Einstellmöglichkeiten nacheinander  
angezeigt:

- “NORMAL” (Normal)
- “SPORT” (Sport)







► Drücken Sie "OK" für mehr als drei Sekunden um die gewählte Einstellung zu bestätigen. Die Anzeige hört auf zu blinken und schaltet nach ein paar Sekunden zurück zu "RPM LIMITER".



► Drücken Sie "OK" für weniger als drei Sekunden und das Display schaltet in den "RUN" Betriebsmodus zurück. Die Einstellung des individuellen Mappings ist abgeschlossen.





#### 4.4.11. Warnung / Störmeldung

Das Instrumentenausrüstung kann das Vorhandensein einer Störung während der verschiedenen Bedingungen von der Verwendung des Motorrads zeigen.

► *Starten des Motors:* Wird der Zündschalter auf "ON" gedreht, wird von den Instrumenten und den Kontrolllampen eine Autodiagnose ausgeführt. Wenn die Autodiagnose eine Störung am Fahrzeug, das Display zeigt die Warnung in der gezeigten Bild. Insbesondere das Display zeigt die Teil des Motorrads, auf denen die Störung festgestellt wurde.

► Die Taste "OK" drücken, bis die Funktion "RUN" angezeigt wird.



#### ACHTUNG

Wird eine Störung am Fahrzeug erkannt, wird nicht den Motor starten und einen autorisierten MV Agusta Kundendienst benachrichtigen.





► *Fahren des Fahrzeugs:* Wenn ein Störung während der Fahrt entdeckt wird, den unteren Teil des Displays dargestellt die Warnung in der Abbildung.

**ACHTUNG**

Wenn ein Störung während der Fahrt festgestellt, das Fahrzeug zu stoppen und einen autorisierten MV Agusta Kundendienst benachrichtigen.

DE 4

► Wenn das Fahrzeug gestoppt wird, das Display zeigt die Teil des Motorrads, auf denen das Störung festgestellt wurde.





► *Hohe Kühflüssigkeitstemperatur:* Wenn eine hohe Kühflüssigkeitstemperatur erkannt wird, das Display zeigt die Warnung in der gezeigten Bild. Diese Warnung kann bei jeder Bedingung von die Verwendung des Fahrzeugs angezeigt.

**ACHTUNG**

Bei hoher Temperatur das Fahrzeug anhalten und den Kühflüssigkeitsstand kontrollieren. Muss nachgefüllt werden, wenden Sie sich bitte an einen autorisierten MV Agusta Kundendienst (siehe § 3.8). Erscheint die Anzeige auch bei richtigem Kühflüssigkeitsstand, nicht weiterfahren und einen autorisierten MV Agusta Kundendienst benachrichtigen.





## 4.5. Tanken

**GEFAHR - ACHTUNG**

Benzin und Benzindämpfe sind leicht entzündbar und giftig. Kontakt mit Benzin und Einatmen vermeiden. Beim Tanken den Motor abschalten und nicht rauchen, offene Flammen und Hitzequellen fernhalten. Im Freien oder in gut belüfteten Räumen tanken.



**Vorsicht - Vorsichtsmassnahme:** Verwenden Sie nur Kraftstoff mit folgenden Eigenschaften:

- Bleifreies Benzin
- Ethanolgehalt bis zu 10% des Volumens
- Oktanzahl (R.O.N.) von 95 oder mehr



Der grüne Punkt auf der unteren Seite der Behälterkappe und der Aufkleber "E10" auf dem Tank dient als Anzeige für den Gebrauch des bleifreien Benzins.



- ▶ Den Staubschutzdeckel anheben.
- ▶ Den Schlüssel einstecken und in Uhrzeigersinn drehen.





- ▶ Den Einfüllstutzen abnehmen und mit Benzin tanken.

**ACHTUNG**

Wird der Tank bis zum Rand gefüllt, kann Benzin austreten, das sich das Benzin durch Sonneneinwirkung oder die Motorwärme ausdehnen kann. Bei austretendem Benzin besteht Brandgefahr. Der Benzinstand darf nie über dem Ende des Einfüllstutzens stehen.

- ▶ Nach dem Tanken den Tankdeckel nach unten drücken und gleichzeitig den Schlüssel in Uhrzeigersinn drehen. Den Schlüssel loslassen und abziehen.



**Vorsicht - Vorsichtsmassnahme: Eventuelle ausgetropftes Benzin sofort mit einem sauberen Lappen abwischen, andernfalls können Lack oder Plastikteile beschädigt werden.**

**ACHTUNG**

Vorm Losfahren prüfen, ob der Tankdeckel richtig verschlossen ist.

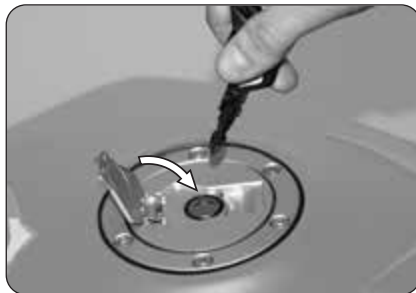



#### 4.6. Entfernung des Beifahrersitzes

- ▶ Den Schlüssel ins Schloss einstecken.
- ▶ Auf das Ende der Sitzbank drücken und gleichzeitig den Schlüssel gegen den Uhrzeigersinn drehen. Die Sitzbank anheben wie in der Abbildung gezeigt.

Zum Wiederaussetzen des Sitzes sind folgende Punkte zu berücksichtigen:

- Den Schlüssel im Schloss drehen;
- Den Sitzbank montieren und haken;
- Den Sitzbank drücken;
- Den Schlüssel loslassen;
- Den Sitz wiederum nach unten drücken und nachprüfen ob er an der Struktur fest befestigt ist.



#### ACHTUNG

Nach Demontage und Montage des Sitzes und vor jedem Motorrad Einsatz muss man sich vergewissern, dass dieser Bauteil korrekt angebracht und an der Tragstruktur des Fahrzeuges gut befestigt ist.

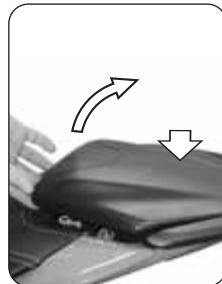
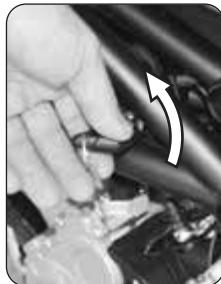



#### 4.7. Entfernung des Fahrersitzes

- ▶ Den Beifahrersitz, wie in Abschnitt §4.6. angegeben, entfernen.
- ▶ Die zwei hinteren Schrauben mit den zugehörigen Abstandshaltern mit einem Sechskantschraubendreher von 4 mm entfernen. Die Sitzbank anheben wie in der Abbildung gezeigt.

Zum Wiederaussetzen des Sitzes sind folgende Punkte zu berücksichtigen:

- Den Sitzbank montieren;
- Die zwei hinteren Schrauben mit den zugehörigen Abstandshaltern montieren;
- Den Beifahrersitz, wie in Abschnitt §4.6. angegeben, montieren.



#### **ACHTUNG**

Nach Demontage und Montage des Sitzes und vor jedem Motorradeinsatz muss man sich vergewissern, dass dieser Bauteil korrekt angebracht und an der Tragstruktur des Fahrzeuges gut befestigt ist.







#### 4.8. Parken des Motorrads

##### Parken auf dem Seitenständer



**ACHTUNG:** Das Motorrad stets sicher auf festem Untergrund abstellen. Beim Parken auf abschüssigem Gelände das Vorderrad bergauf stellen und den ersten Gang einlegen. Vorm Starten muss wieder der Leerlauf eingelegt werden. Niemals den Zündschlüssel stecken lassen, wenn das Fahrzeug unbeaufsichtigt ist.



**ACHTUNG:** Wird das Motorrad zum Parken auf den Seitenständer gestellt, ist es gefährlich sich auf das Fahrzeug zu setzen, da das gesamte Gewicht nur auf dem Seitenständer aufliegt. Vorm Losfahren die Funktion des Sicherheitsschalters prüfen. Die Kontrolllampe am Armaturenbrett für den abgeklappten Seitenständer muss sich ausschalten. Auf jeden Fall prüfen, dass der Seitenständer richtig hochgeklappt ist. Wird eine Störung bemerkt, muss die Anlage vor Fahrtantritt bei einem MV Agusta Vertragshändler überprüft werden.

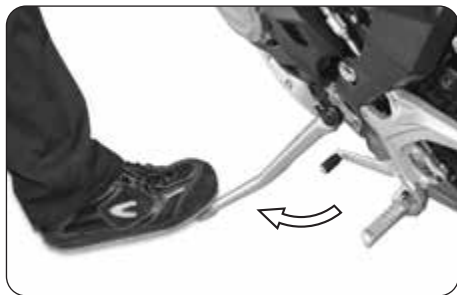

► Den Seitenständer mit dem Fuß bis zum Anschlag ausklappen und das Motorrad langsam neigen, bis der Ständerfuß auf dem Untergrund fest aufliegt.



### ☐ Parken auf dem hinteren Ständer

Den Zapfen des Ständer von der linken Fahrzeugseite aus in die Öffnung an der Radachse stecken. Den Ständer auf den Boden stellen, festhalten und das Fahrzeug soweit anheben, bis es sicher steht.



#### **ACHTUNG**

Dieser Vorgang muss von zwei Personen zusammen ausgeführt werden.





### 5.1. Liste der Einstellungsarbeiten

Das Motorrad bietet eine breite Auswahl von Einstellungsmöglichkeiten, die Ergonomie, die Sitzposition und die Sicherheit verbessern können.

Da eine falsche Einstellung von wichtigen Komponenten eine Gefahrenquelle darstellen kann, dürfen einige dieser Einstellungen nur von einer MV Agusta-Vertragswerkstatt vorgenommen werden.



#### **ACHTUNG**

**Alle Einstellungsarbeiten müssen bei stehendem Fahrzeug vorgenommen werden**



(F) Einstellung Rückspiegel (§5.6.)

(H) Einstellung vordere Federung (§5.7.)

(A) Einstellung Bremshebel

Vorderradbremse (§5.3.)

(M) Einstellung

Scheinwerfer (§5.9.)

(D) Einstellung Bremspedal

Hinterradbremse (§5.2.)

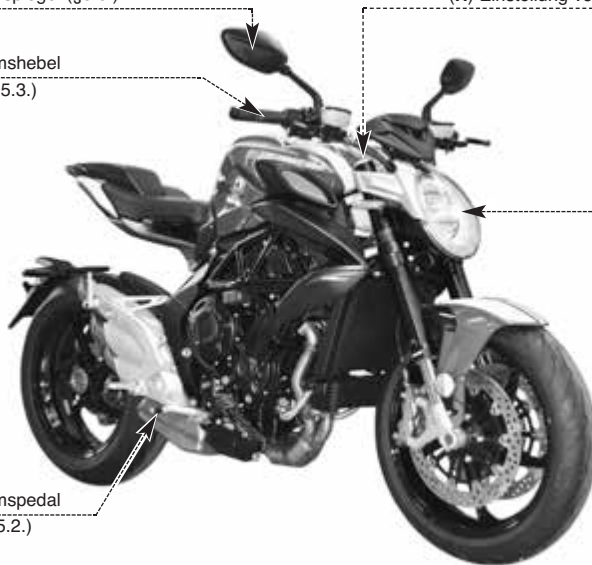



(F) Einstellung Rückspiegel (§5.6.)

(E) Einstellung Lenkungsämpfer  
(Brutale RR) (§5.5.)

(B) Einstellung  
Kupplungshebel (§5.4.)

(L) Einstellung hintere Federung (§5.8.)

(C) Einstellung  
Schaltpedal (§5.2.)

(G) Einstellung Kette (§5.2.)

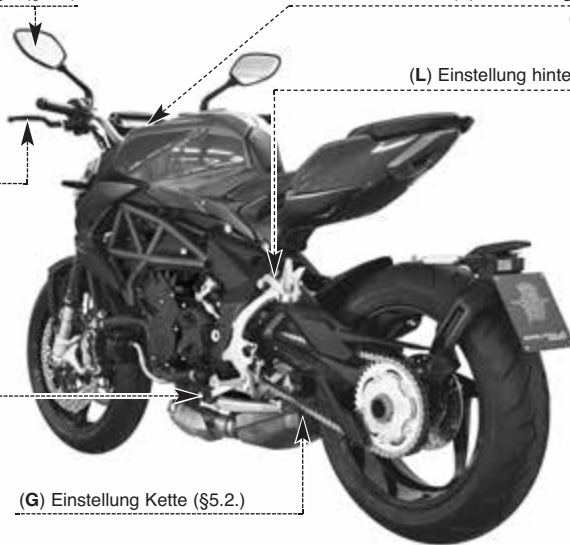



## 5.2. Tabelle der Einstellungsarbeiten

	<b>A - Einstellung Bremshebel Vorderradbremse:</b> Bessere Einstellung des Bremshebels auf die persönlichen Anforderungen des Fahrers (§5.3).		<b>G - Einstellung Kette:</b> Für Funktion und Sicherheit des Antriebs.
	<b>B - Einstellung Kupplungshebel:</b> Bessere Einstellung des Bremshebels auf die persönlichen Anforderungen des Fahrers (§5.4).		<b>H - Einstellung vordere Federung:</b> um die Federung an den persönlichen Fahrstil anzupassen, gibt es folgende Einstellmöglichkeiten: <ul style="list-style-type: none"><li>- Federvorspannung (§5.7.1.)</li><li>- Hydraulische Ausdehnungsbremse (§5.7.2.)</li><li>- Hydraulische Kompressionsbremse (§5.7.3.)</li></ul>
	<b>C - Einstellung Schaltpedal:</b> Bessere Einstellung des Schaltpedals auf die persönlichen Anforderungen des Fahrers.		
	<b>D - Einstellung Bremspedal Hinterradbremse:</b> Bessere Einstellung des Bremspedals auf die persönlichen Anforderungen des Fahrers.		
	<b>E - Einstellung Lenkungsdämpfer (Brutale RR):</b> Einstellung der Dämpfung auf die persönlichen Anforderungen des Fahrers (§5.5).		<b>L - Einstellung hintere Federung:</b> um die Federung an den persönlichen Fahrstil anzupassen, gibt es folgende Einstellmöglichkeiten: <ul style="list-style-type: none"><li>- Höhe Sitzposition</li><li>- Federvorspannung</li></ul>
	<b>F - Einstellung Rückspiegel:</b> Zur besseren Einstellung (§5.6).		<ul style="list-style-type: none"><li>- Hydraulische Ausdehnungsbremse (§5.8.1.)</li><li>- Hydraulische Kompressionsbremse (§5.8.2.)</li></ul>
	 <b>ACHTUNG:</b> Die Befestigungsschraube des Lenkerrückspiegels nie ausschrauben. Falls notwendig wenden Sie sich bitte nur einem MV Agusta-Händler.		<b>M - Einstellung Scheinwerfer:</b> Um den Lichtstrahl des Scheinwerfers entsprechend der Sitzposition einzustellen (§5.9).



### 5.3. Einstellung Bremshebel Vorderradbremse

Die Stellvorrichtung des Hebels drehen, um die Position zu verändern.

Im Uhrzeigersinn: Der Hebel bewegt sich auf den Drehknopf zu.  
Gegen den Uhrzeigersinn: Der Hebel bewegt sich vom Drehknopf weg.



### 5.4. Einstellung Kupplungshebel

Die Stellvorrichtung des Hebels drehen, um die Position zu verändern.

Im Uhrzeigersinn: Der Hebel bewegt sich auf den Drehknopf zu.  
Gegen den Uhrzeigersinn: Der Hebel bewegt sich vom Drehknopf weg.

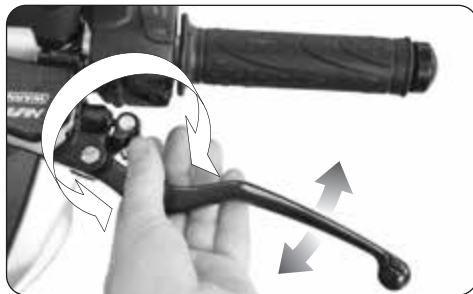



### 5.5. Einstellung Lenkungsdämpfer (Brutale RR)

Für die Standardeinstellung wird der Einstellungsknauf gegen den Uhrzeigersinn bis zum Anschlag gedreht. In dieser Stellung wird die Lenkung am wenigsten gedämpft.

Je nach persönlichen Bedürfnissen kann die Dämpfungswirkung durch Drehen des Einstellungsknauf in Uhrzeigersinn erhöht werden.

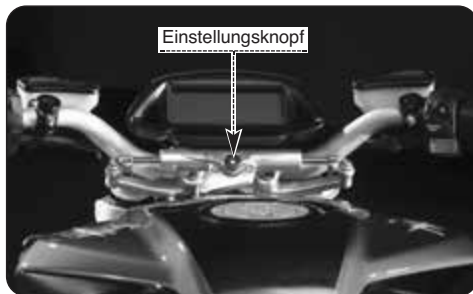





## 5.6. Einstellung Rückspiegel

Zur Einstellung des Rückspiegels an den vier in der Abbildung gezeigten Stellen, die Rückspiegelkörper drehen.

Die Einstellung beider Rückspiegel durchführen. Zur Durchführung einer korrekten Rückspiegel-einstellung ist es ratsam auf das Motorrad zu steigen.





## 5.7. Einstellung vordere Federung

**ANMERKUNG:** Die Einstellung der Federungen muß vorzugsweise mit dem Benzintank volle durchgeführt werden.

### 5.7.1. Federvorspannung (Vorderradfederung)

Für die Einstellungsarbeiten muß von der Standardeinstellung ausgegangen werden. Um die Standardeinstellung zu erreichen, gegen den Uhrzeigersinn bis zum Anschlag drehen, anschließend in Uhrzeigersinn bis Standardposition (siehe Tabelle) drehen. In Uhrzeigersinn drehen um die Federvorspannung zu erhöhen, gegen den Uhrzeigersinn drehen, um die Federvorspannung abzuschwächen.





## 5.7.2. Hydraulische Ausdehnungsbremse (Vorderradfederung)

Für die Einstellungsarbeiten muß von der Standardeinstellung ausgegangen werden. Um die Standardeinstellung zu erreichen, in Uhrzeigersinn bis zum Anschlag drehen, anschließend gegen den Uhrzeigersinn bis Standardposition (siehe Tabelle) drehen. In Uhrzeigersinn drehen um die Bremsleistung zu erhöhen, gegen den Uhrzeigersinn drehen, um die Bremsleistung abzuschwächen.

## 5.7.3. Hydraulische Kompressionsbremse (Vorderradfederung)

Für die Einstellungsarbeiten muß von der Standardeinstellung ausgegangen werden. Um die Standardeinstellung zu erreichen, in Uhrzeigersinn bis zum Anschlag drehen, anschließend gegen den Uhrzeigersinn bis Standardposition (siehe Tabelle) drehen. In Uhrzeigersinn drehen um die Bremsleistung zu erhöhen, gegen den Uhrzeigersinn drehen, um die Bremsleistung abzuschwächen.





## 5.8. Einstellung hintere Federung



### ACHTUNG

Der Stoßdämpfer enthält unter hohem Druck stehendes Gas. Den Stoßdämpfer auf keinen Fall zerlegen.

**ANMERKUNG:** Die Einstellung der Federungen muß vorzugsweise mit dem Benzintank volle durchgeführt werden.

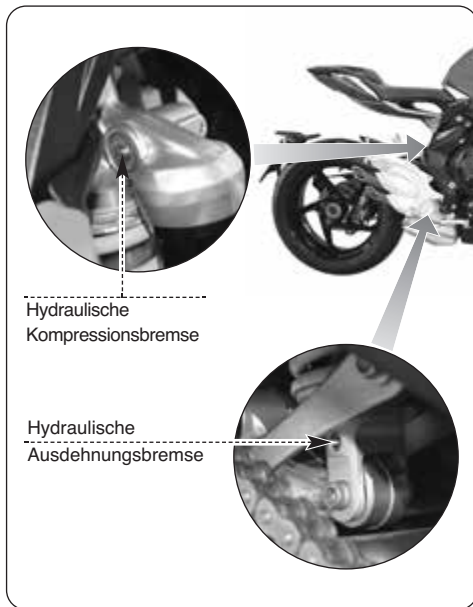



## 5.8.1. Hydraulische Ausdehnungsbremse (Hinterradfederung)

Für die Einstellungsarbeiten muß von der Standardeinstellung ausgegangen werden. Um die Standardeinstellung zu erreichen, in Uhrzeigersinn bis zum Anschlag drehen, anschließend gegen den Uhrzeigersinn bis Standardposition (siehe Tabelle) drehen. In Uhrzeigersinn drehen um die Bremsleistung zu erhöhen, gegen den Uhrzeigersinn drehen, um die Bremsleistung abzuschwächen.

## 5.8.2. Hydraulische Kompressionsbremse (Hinterradfederung)

Für die Einstellungsarbeiten muß von der Standardeinstellung ausgegangen werden. Um die Standardeinstellung zu erreichen, in Uhrzeigersinn bis zum Anschlag drehen, anschließend gegen den Uhrzeigersinn bis Standardposition (siehe Tabelle) drehen. In Uhrzeigersinn drehen um die Bremsleistung zu erhöhen, gegen den Uhrzeigersinn drehen, um die Bremsleistung abzuschwächen.





### 5.9. Scheinwerfereinstellung

Das Fahrzeug auf ebenem Untergrund in einem Abstand von 10 m vor eine Wand stellen. Das Fahrzeug muss aufrecht senkrecht zur Wand stehen. Den Abstand zwischen Scheinwerfermitte und Boden messen. Den Wert an der Wand mit einem Kreuz anzeichnen. Den Scheinwerfer einschalten und Fahrlicht einstellen. Den Lichtstrahl so einstellen, dass sich die Hell-Dunkel- Linie 9/10 unterhalb der an der Wand angebrachten Linie befindet.

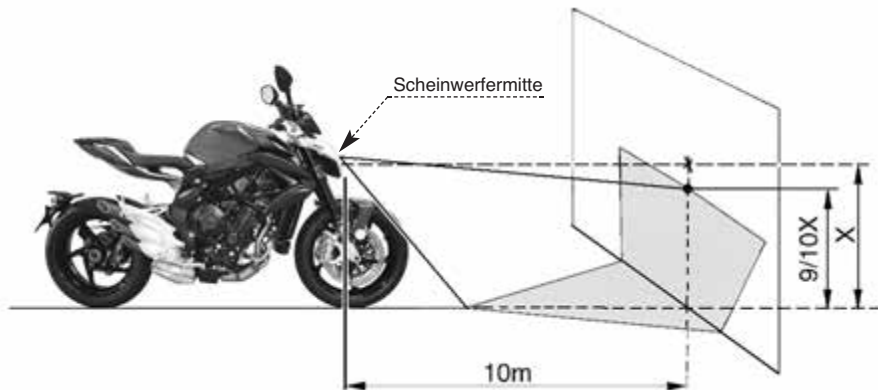



Die Einstellung des vorderen Scheinwerfers kann bei Betätigung der abgebildeten Schraube erfolgen. In Uhrzeigersinn: der Scheinwerfer wird nach unten geneigt. Gegen den Uhrzeigersinn: der Scheinwerfer wird nach oben geneigt. Die Neigung, hinsichtlich der Standardposition, kann von  $\pm 4^\circ$  geändert werden.

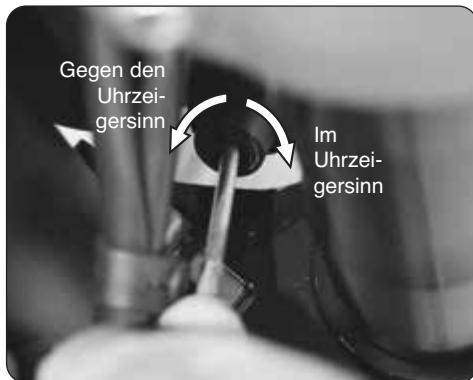



### Informationshinweis

MV Agusta Motor S.p.A. verfolgt eine Politik ständiger Verbesserung ihrer Produkte. Aus diesem Grund kann es vorkommen, dass kleine Abweichungen zwischen dem vorliegenden Dokument und dem von Ihnen erworbenen Fahrzeug bestehen. Die Modelle MV Agusta werden in zahlreiche Länder exportiert, in denen unterschiedliche Straßenverkehrsordnungen und Zulassungsverfahren bestehen. In der Hoffnung auf Ihr Verständnis behält sich MV Agusta Motor S.p.A. deshalb das Recht vor, jederzeit und ohne Vorankündigung, Änderungen an ihren Produkten und den technischen Dokumentationen vorzunehmen.

Wir schlagen vor, um den Internetplatz [www.mvagusta.it](http://www.mvagusta.it) häufig zu besichtigen, um Informationen und Updates über die MV Agusta-Produkte und die in Verbindung stehenden Unterlagen zu erhalten.



### Die Umwelt schützen und respektieren

Alles was wir tun hat Auswirkungen auf den gesamten Planeten und seine Ressourcen. Zum Schutz der Gemeinschaft weist MV Agusta die Kunden und die Angestellten im Kundendienst darauf hin, wie das Motorrad umweltschonend genutzt und Motorradbauteile und Flüssigkeiten entsprechend der geltenden Umweltschutzgesetze entsorgt bzw. dem Recycling zugeführt werden können.

© 2017

Die vollständige oder teilweise Vervielfältigung dieses Dokuments ist ohne vorherige schriftliche Genehmigung der MV Agusta Motor S.p.A. verboten.

Teilnr. n° 8000C5107

Ausgabe n° 1 - November 2017





## ANMERKUNG

DE 5

**BRUTALE  
8000-RR**

**MV AGUSTA**



**Manual de uso**  
*Versión en Español*

*Estimado cliente,*

*Le agradecemos la confianza que nos ha otorgado y le felicitamos por su nueva Brutale.*

*MV Agusta, gracias a la pasión y a la escrupulosidad de sus técnicos se propone nuevamente a sus aficionados con un producto caracterizado por una inédita cualidad estética junto a una refinada parte ciclística: elementos que han contramarcado todas las creaciones de la marca MV Agusta a lo largo de su gloriosa historia.*

*El resultado es una moto exclusiva que por sus características estéticas y funcionales y las innumerables innovaciones técnicas, se coloca por encima de productos de mas alto perfil que el mercado de la moto pueda ofrecer hoy.*

*Las soluciones adoptadas otorgan, en efecto, a Brutale ese inconfundible carácter que la atan a los otros modelos de la familia MV Agusta, reforzando una filosofía de proyecto que privilegia la constante búsqueda, innovación tecnológica y el amor por el detalle, dando la posibilidad a quien vive la propia pasión de motociclista en plena libertad, de poseer un objeto único en el mundo que se coloca con prepotencia como referencia en el ámbito mundial.*

*Si desea más información, no dude en ponerse en contacto con el Servicio de Asistencia Clientes de MV Agusta.*

*¡Buena diversión!*

*Giovanni Castiglioni  
Presidente  
MV Agusta*



## ÍNDICE GENERAL

Cap.	Descripción temas	pág.
<b>1</b>	<b>INFORMACIÓN GENERAL</b>	<b>5</b>
1.1.	Finalidad del manual	5
1.2.	Símbolos	6
1.3.	Certificado de entrega	7
1.4.	Datos de identificación	8
<b>2</b>	<b>INFORMACIÓN SOBRE LA SEGURIDAD</b>	<b>11</b>
2.1.	Garantía del vehículo	11
2.2.	Mantenimiento programado	12
2.3.	Carga vehículo	14
<b>3</b>	<b>MANDOS Y INSTRUMENTOS</b>	<b>15</b>
3.1.	Posición mandos y instrumentos	15
3.2.	Caballote lateral	17
3.3.	Mandos en el lado izquierdo del manillar	18
3.4.	Mandos en el lado derecho del manillar	20
3.5.	Interruptor encendido y bloqueo del manillar	23
3.6.	Mando cambio	26
3.7.	Instrumentos y testigos	27
3.7.1.	Testigos	28
3.7.2.	Display multifunción	29
3.8.	Tabla de lubricantes y líquidos	30

Cap.	Descripción temas	pág.
<b>4</b>	<b>USO</b>	<b>31</b>
4.1.	Uso de la motocicleta	31
4.2.	Rodaje	32
4.3.	Arranque del motor	34
4.4.	Selección y modificación funciones display	37
4.4.1.	Selección de las funciones de la pantalla	38
4.4.2.	Reset de las funciones cuenta kilómetros parciales	43
4.4.3.	Función "SPEED LIMITER"	45
4.4.4.	Función TC	47
4.4.5.	Cronómetro	48
4.4.6.	Selección de las funciones ABS	57
4.4.7.	Función "QUICK SHIFT"	58
4.4.8.	Configuración del reloj	60
4.4.9.	Función "IMMOBILIZER"	62
4.4.10.	Selección del mapeado de la central	65
4.4.11.	Mensajes de advertencia/error	77
4.5.	Abastecimiento combustible	80
4.6.	Extracción del asiento pasajero	82
4.7.	Extracción del asiento del piloto	83
4.8.	Estacionamiento de la motocicleta	84



## ÍNDICE GENERAL

<i>Cap.</i>	<i>Descripción temas</i>	<i>pág.</i>
<b>5</b>	<b>REGULACIONES</b>	<b>86</b>
5.1.	Lista regulaciones	86
5.2.	Tabla de las regulaciones	89
5.3.	Regulación de la palanca del freno delantero	90
5.4.	Regulación de la palanca del embrague	90
5.5.	Regulación de l'amortiguador de dirección (Brutale RR)	91
5.6.	Regulación de los espejos retrovisores	92
5.7.	Regulación de la suspensión delantera	93
5.7.1.	Precarga muelle (suspensión delantera)	93
5.7.2.	Dispositivo hidráulico de frenado en extensión (suspensión delantera)	94
5.7.3.	Dispositivo hidráulico de frenado en compresión (suspensión delantera)	94
5.8.	Regulación de la suspensión trasera	95
5.8.1.	Dispositivo hidráulico de frenado en extensión (suspensión trasera)	96
5.8.2.	Dispositivo hidráulico de frenado en compresión (suspensión trasera)	96
5.9.	Ajuste proyector delantero	97



## 1.1. Finalidad del manual

El presente manual proporciona toda la información necesaria para un uso correcto y seguro de la moto.

El manual se entrega también en formato electrónico (.pdf) en este soporte digital, y puede ser impreso o visualizado en cualquier ordenador, ya sea en sistema Windows que Macintosh.

Le recomendamos leer atentamente el manual antes de utilizar la moto y cerciorarse de cualquier otra persona que la use haya hecho lo mismo.

En el soporte digital, que se suministra junto con la moto, podréis encontrar, además de este manual, el Manual de Mantenimiento, la Guía de las Concesionarias y el Manual de la Garantía.



Copyright  
MV AGUSTA Motor Spa  
Todos los derechos reservados



## 1.2. Símbolos

Las partes del texto de particular importancia, correspondientes a la seguridad de la persona y a la integridad de la motocicleta, están evidenciadas con los siguientes símbolos:



**Peligro - Atención:** la falta o el incompleto cumplimiento de estas prescripciones puede comportar un grave peligro para su incolumidad o para la de otras personas.



**Prudencia - Precaución:** la falta o el incompleto cumplimiento de estas prescripciones puede comportar un riesgo de daños a la motocicleta.

Para indicar las personas autorizadas al desarrollo de las operaciones de ajustes y/o mantenimiento, las mismas se encuentran marcadas con los símbolos siguientes:



**Información de las operaciones permitidas al motociclista.**



**Información de las operaciones que deben ser llevadas a cabo sólo por personal autorizado.**

Para poner en evidencia ulteriores informaciones se utilizan los siguientes símbolos:



El símbolo  indica que es necesario utilizar una herramienta o utillaje específico para realizar correctamente la operación descrita.



El símbolo “§” indica que nos remitimos al capítulo indicado por el número que lo sigue.



## 1.3. Certificado de entrega

Al momento de la entrega de la motocicleta, su Concesionario le habrá entregado también el Certificado de Garantía y Pre-Entrega.

Le rogamos conservarlo junto con los documentos de la moto y los futuros cupones de mantenimiento que recibirá cada vez que realice las intervenciones programadas.

### **IMPORTANTE**

Las copias del Certificado de Garantía y Pre-entrega deben ser rellenas por el Concesionario. Una copia debe ser entregada al Cliente, una se debe mantener por el Concesionario y una debe ser enviada al Importador.

Las copias de los cupones de manutención recomendada deben ser rellenas siempre por el Concesionarios. Dichas copias deben permanecer en poder del Cliente.





## 1.4. Datos de identificación

- 1) número de matrícula chasis
- 2) número de matrícula motor
- 3) datos de homologación

### ► Identificación motocicleta

La motocicleta está identificada por el número de matrícula del chasis. Para pedir piezas de recambio, además de este número, puede ser necesario indicar el número de matrícula del motor, el código del color y el número de identificación de la llave.

Se recomienda anotar los datos principales en los siguientes espacios.

**BASTIDOR N.:** \_\_\_\_\_

**MOTOR N.:** \_\_\_\_\_



### ► **Identificación de la llave de la motocicleta**

Se suministran dos llaves, una llave se utiliza sea para el arranque para accionar las cerraduras. Guarde en un lugar seguro la llave de reserva.

Tener conocimiento del número de identificación de la llave es indispensable en el caso sea necesario pedir un duplicado de la llave como recambio. El número de identificación de la llave esta impreso sobre la MV Code Card que viene junto con las llaves de arranque.

**1** ES

### ► **Identificación combinación colores motocicleta**

El código del color es indispensable para pedir las piezas de recambio de la carrocería. El mismo puede ser leído en la placa colocada en el lado inferior trasero del deposito gasolina.

Para acceder a la placa del código color, es necesario quitar el sillín del pasajero y del piloto como se describe en los párrafos §4.6. y §4.7.





ES  
1

Después de haber quitado los asientos se pueda ver la placa con el código color. En ésta placa es posible conocer el código del color de la motocicleta, el cual determina el color de las partes de la carrocería.

Se aconseja anotar el código color de la motocicleta en el espacio siguiente:

**CÓDIGO COLOR:** .....

Para obtener los colores de referencia de las partes pintadas en relación al código de color de la motocicleta, consulte el Manual de Mantenimiento incluido en el soporte digital suministrado.

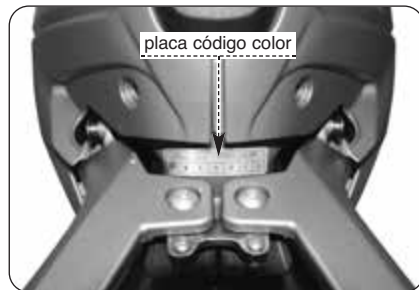



## 2.1. GARANTÍA DEL VEHÍCULO



### ATENCIÓN

Le recordamos que la garantía no se aplica si el vehículo ha sido utilizado en competiciones de motociclismo, realizadas en pista como en carreteras públicas, por tratarse de un uso diferente que no es compatible con el uso en carretera para el cual su vehículo ha sido diseñado específicamente.

Además, la garantía no opera en el caso de que el vehículo se utilice para actividades profesionales como, a título indicativo pero no exhaustivo, servicio de taxi, alquiler, etc.

Le advertimos, asimismo, que MV Agusta se reserva el derecho de evaluar la operatividad de la garantía en todos los casos, sin excluir ninguno, donde se constatare que su vehículo ha sido modificado respecto a su configuración original y así también si se han

usado repuestos y/o accesorios originales MV Agusta y montados por el Servicio de Asistencia Técnica en un Concesionario MV Agusta.

Le evidenciamos, además, que la garantía no se aplica en caso que en cada intervención, de revisión de mantenimiento como de cualquier otra intervención de reparación, ajuste, sustitución u otro tipo de intervención, sea realizado por talleres y/o por técnicos y/o por centros de asistencia y reparación y, en general, por cualquier tercero que no haya obrado según los estándares técnicos y de procedimiento que MV pone a disposición del personal técnico cualificado para el mantenimiento correcto del vehículo (cursos técnicos, equipamiento específico de taller, manuales, repuestos, etc.) de MV Agusta y/o no haya utilizado repuestos y/o accesorios originales MV Agusta.



De todos modos, le precisamos que la garantía no cubre las partes sujetas a desgaste o deterioro (lubricantes y líquidos varios, bujías, embrague, filtros, cadena, corona, piñón, pastillas de frenos, discos de freno, neumáticos, tuberías y partes de goma, batería, lámparas y fusibles), a eventos derivados de ineptitud y/o incuria y/o por exposición a agentes atmosféricos (lavado de la pintura, corrosiones, etc.) y/o por superación de los límites de carga previstos en el Manual de uso del vehículo.

Se recuerda que, como así lo requiere la Ley, esta garantía ha sido dada directamente por su concesionario MV Agusta a quien le rogamos dirigirse en caso de necesidad y es válida, también en el exterior, en cualquier otro concesionario de la red MV Agusta.

## 2.2. MANTENIMIENTO PROGRAMADO



### ATENCIÓN

Le advertimos que en el caso de que su vehículo presente roturas o mal funcionamientos por no haber realizado las revisiones de mantenimiento, su concesionario podrá negarse a intervenir en garantía y, contemporáneamente, el concesionario y MV Agusta S.p.A. no podrán ser considerados responsables por posibles daños sufridos por el vehículo y/o por el usuario y/o por terceros y/o a cosas de terceros, a causa de las antedichas roturas o mal funcionamientos.

Todas las revisiones de mantenimiento, incluido aquella inicial tienen un costo, relativo al material y a la mano de obra.

MV Agusta le aconseja que todas las operaciones realizadas en el vehículo, ya sea que se trate de revisiones de mantenimiento como de toda otra



intervención de reparación, ajuste, sustitución o otro tipo de intervención sea realizada en los talleres autorizados de los concesionarios MV Agusta según las modalidades expuestas en el manual de mantenimiento, en el manual de taller y en las circulares técnicas publicadas por MV Agusta S.p.A. pues MV Agusta garantiza la ejecución correcta de cualquier intervención sólo y exclusivamente si se las realiza en talleres autorizados de los Concesionarios MV Agusta que operan según los estándares técnicos y de procedimiento de MV Agusta y utilizan exclusivamente repuestos y accesorios originales.

Después de cada revisión de mantenimiento obligatorio, controle siempre que el relativo cupón de revisión esté sellado y firmado por el Concesionario y verifique que la intervención realizada corresponda con sus expectativas.

Encontrará los cupones de las revisiones mencionados al pie de la Garantía.

Guarde la Garantía con los cupones de las revisiones sellados por el concesionario MV Agusta y los relativos recibos fiscales y, en caso de traspaso del vehículo, entréguela al nuevo comprador.

## Vencimientos de las tareas de mantenimiento programado

Frecuencia Km (mi)*	1000 (600)	Cada año	15000 (9000)	30000 (18000)	45000 (27000)	60000 (36000)	75000 (45000)	90000 (54000)	105000 (63000)
Cupón	A		B	C	D	E	F	G	H

(\*): Los cupones de kilometraje se pueden llevar junto con el cupón anual **obligatorio**



### 2.3. CARGA DEL VEHICULO

El vehículo ha sido proyectado para ser usado por parte del piloto y de un eventual pasajero. Para utilizarlo en plena seguridad y respetando las normas del código de la circulación es obligatorio no superar nunca el peso bruto total máximo permitido del vehículo, el cual valor es indicado a continuación:

#### BRUTALE 800 - RR

Masa máxima técnicamente admisible

**379 kg**

Masa máxima transportable

**180 kg**

La masa máxima técnicamente admisible representa la adición de las siguientes masas:

- massa de la motocicleta;
- massa del piloto
- massa del pasajero;
- massa del equipaje y de los accesorios.



#### ATENCIÓN

Considerado que la carga tiene una enorme importancia en la manejabilidad, la frenada, el rendimiento y las características de seguridad de vuestro vehículo, tener presente siempre las siguientes precauciones.

- **NO SOBRECARGAR NUNCA EL VEHICULO!** La utilización de una moto sobre cargada puede provocar daños a los neumáticos, pérdida del control o graves accidentes. Comprobar que el peso total del piloto, del pasajero, de la carga y de los accesorios no supere el peso máximo especificado para la moto.



## 3.1. Posición mandos e instrumentos

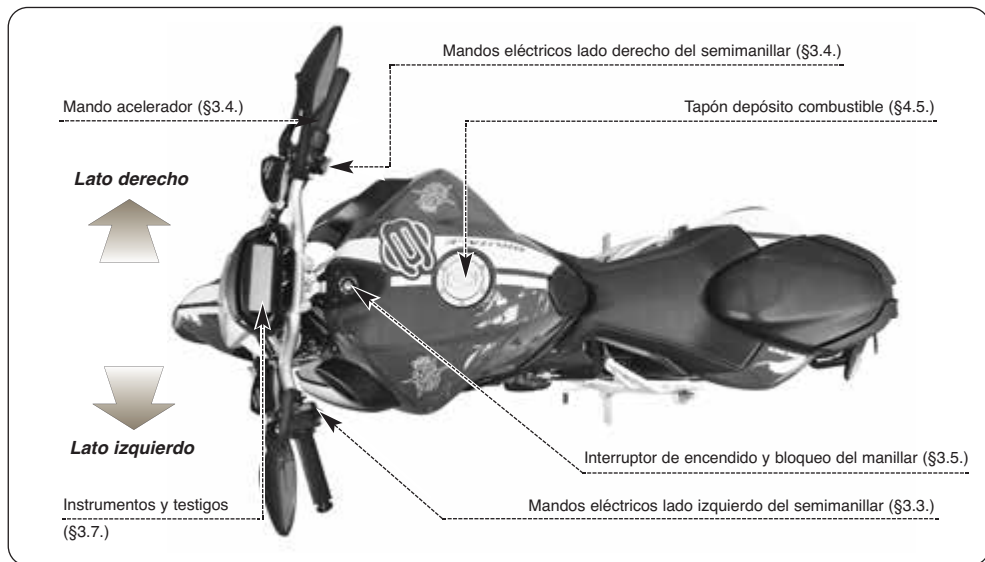





ES 3

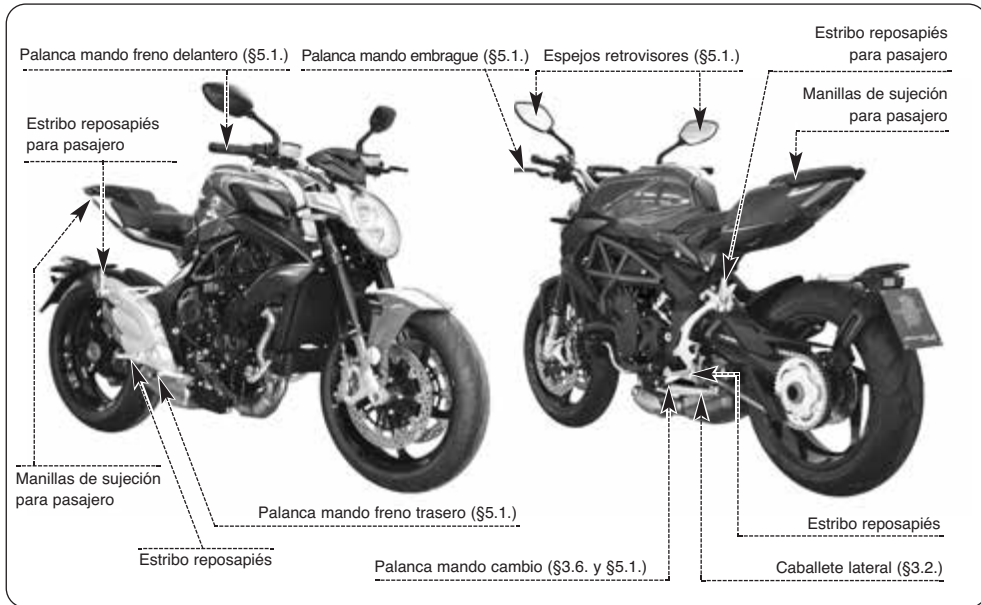



### 3.2. Caballete lateral

El caballete lateral está equipado con un interruptor de seguridad que impide a la moto de ponerse en marcha con el caballete bajado.

En el caso que con el motor en marcha y con el caballete bajado, se acciona el cambio para salir, el interruptor corta la corriente al motor provocando la parada.

En el caso que la moto se encuentre estacionada (con el caballete abajo) y con una velocidad engranada, el interruptor impide el arranque del motor evitando el peligro de caída accidental del vehículo.





## 3.3. Mandos lado izquierdo del manillar

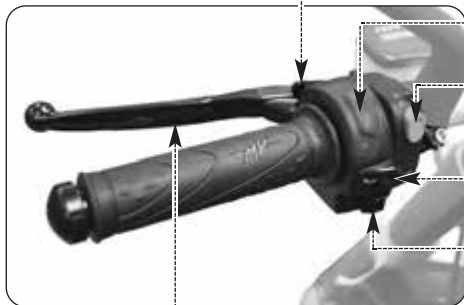

### **Pulsador centelleo faros**

Apriete el pulsador repetidas veces.

### **Pulsador SET/OK**

Pulsar para modificar las funciones del salpicadero (§ 4.4).

### **Pulsador carretera/cruce**

Pulsador hacia fuera  : cruce 

Pulsador hacia dentro  : carretera 

### **Pulsador claxon**

Apriete para activar el claxon.

### **Palanca indicadores de dirección**

Desplazando la palanca hacia la derecha o hacia la izquierda se activan los indicadores de dirección derechos o izquierdos. La palanca regresa al centro; apriete para desactivar los indicadores.

### **Palanca embrague**

Acercar o alejar de la manecilla para accionar el embrague.



### **Pulsador Destello Faro**

Esta función sirve para llamar la atención de los demás en el caso de posible situaciones de peligro; con la luz de carretera encendida dicha función no se activa.

### **Pulsador SET/OK**

El pulsador SET permite seleccionar las diferentes funciones de la pantalla para realizar los ajustes, mientras el pulsador OK permite confirmar los valores configurados.

### **Pulsador De carretera/De cruce**

Normalmente es activada la función luz de cruce; cuando las condiciones del tráfico y de recorrido lo permiten, puede ser activada la función luz de carretera actuando en el pulsador.

### **Leva Indicadores de Dirección**

Esta función permite señalar a los demás la intención de cambiar dirección o carril de marcha.



**PELIGRO: No usar o no desactivar los indicadores de dirección en el momento oportuno puede provocar accidentes; los demás conductores podrían interpretar erróneamente el trayecto del vehículo. Accionar siempre los indicadores de dirección antes de girar o cambiar carril. Asegurarse después de desactivar los indicadores apenas efectuada dicha maniobra.**

### **Pulsador del Claxon**

Esta función sirve para llamar la atención de los demás en el caso de posibles situaciones de peligro.

### **Palanca Embrague**

Esta palanca permite accionar el embrague.



## 3.4. Mandos lado derecho del manillar

### **Botón luces de emergencia**

Pulsar para activar o desactivar las luces de emergencia.

### **Pulsador "Engine Map"**

Presionar para determinar el mapeado de la central (§4.4.10.).

### **Interruptor stop motor**

Si se acciona detiene el motor e impide su arranque.

### **Pulsador arranque motor**

Apretado arranca el motor. Se debe soltar apenas arranca el motor.

### **Mando acelerador**

Girar para regular la alimentación del motor.

### **Palanca de las luces nocturnas / luces diurnas (DRL) \***

Desplazando la palanca hacia arriba o hacia abajo se activan las luces nocturnas (luz de carretera/de cruce) o las luces de posición diurnas (Day Running Lights).

### **Palanca freno delantero**

Acercarse a la manecilla para accionar el freno delantero.

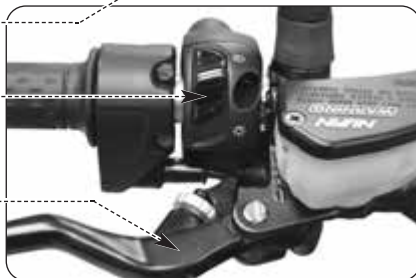
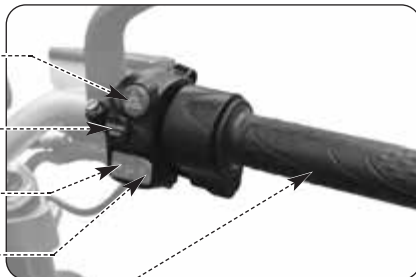

(\*): Excluidas las versiones Japón y Australia



### Botón luces de emergencia

Esta función sirve para llamar la atención de los demás en el caso de posibles situaciones de peligro.

### Pulsador “Engine Map”

Este pulsador permite determinar automáticamente el mapeado de la central (ver §4.4.10).

### Interruptor Parada Motor

Esta función permite parar el motor; de ésta manera se desactiva el circuito de encendido impidiendo el arranque del motor. Para poder efectuar el arranque colocar nuevamente el pulsador en posición de descanso.

**NOTA: En condiciones normales, utilizar éste dispositivo para parar el motor.**

### Pulsador Puesta en marcha del Motor

Este dispositivo permite la puesta en marcha del motor; además con el motor en marcha permite seleccionar las funciones del display presente en la instrumentación de a bordo.



**PRUDENCIA - PRECAUCION:** Para evitar daños a la instalación eléctrica no tener presionado el pulsador por mas de 5 segundos consecutivos. Si el motor no arranca después de varios tentativos, consultar el capítulo “AVERÌAS” en el Manual del mantenimiento.

### Mando Acelerador

Este dispositivo permite regular la alimentación del motor variando el régimen de rotación. Para accionar el dispositivo es necesario girar la manecilla en la posición de descanso, que corresponde al régimen de ralentí del motor.



**CUIDADO:** Si la moto se ha caído o ha estado involucrada en un accidente, lleve el vehículo a un centro de servicio MV Agusta al para comprobar el funcionamiento del mando del acelerador antes de reanudar la marcha.

**Palanca de las luces nocturnas / luces diurnas (DRL) \***

Este dispositivo permite activar alternativamente los dispositivos de iluminación diurnos (Day Running Lights) o nocturnos (luz de carretera / de cruce - ver §3.3) según las condiciones de iluminación externas.

**Palanca Freno Delantero**

Este mando permite accionar a través de un circuito hidráulico la instalación de frenos de la rueda delantera.

**❑ Sistema de antibloqueo de frenos (ABS)**

Los modelos Brutale están equipados con un sistema asistido de frenado ABS ("Antilock Braking System"), que evita que las ruedas se bloqueen durante las frenadas de emergencia, lo que garantiza la estabilidad del vehículo y acorta la distancia de frenado.



**ATENCIÓN:** Cuando el sistema ABS está activado, algunas vibraciones podría ser perceptibles en la palanca de freno o en el pedal de freno. En este caso, se recomienda mantener presionados los dispositivos de accionamiento de los frenos, de modo que el vehículo puede completar el frenado.



**ATENCIÓN:** Si el sistema ABS tiene una avería o está desactivado, la luz de advertencia correspondiente en el tablero de instrumentos se enciende (ver § 3.7.1.). Desde este momento, el sistema de antibloqueo de frenos no podría estar disponible durante el frenado. Si hay una avería en el sistema ABS, se recomienda volver a la marcha a baja velocidad y contactar con un centro de servicio autorizado MV Agusta. Si el sistema ABS está desactivado, seguir el procedimiento de activación descrito en § 4.4.6.

*(\*): Excluidas las versiones Japón y Australia*



## 3.5. Interruptor de encendido y bloqueo del manillar



**PELIGRO:** No colocar llaveros u otros objetos en la llave de encendido para no crear obstáculos en la rotación de la dirección.



**PELIGRO:** No intentar cambiar la posición del interruptor durante la marcha; se podría perder el control del vehículo

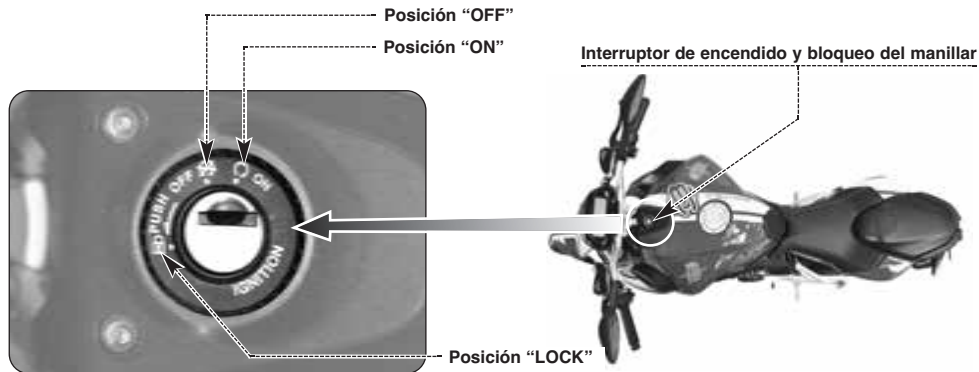





El interruptor de encendido activa y desactiva el circuito eléctrico y el bloqueo del manillar; las cuatro posiciones de mando se describen a continuación.

### Posición “OFF”

Todos los circuitos eléctricos están desactivados. Se puede extraer la llave.

### Posición “ON”

Todos los circuitos eléctricos están activados, los instrumentos y los testigos efectúan el autodiagnóstico; se puede arrancar el motor. La llave no se puede extraer.



**PRUDENCIA - PRECAUCION:** No dejar la llave en la posición de “ON” por mucho tiempo con el motor apagado, para no dañar los componentes eléctricos de la motocicleta.



## Posición "LOCK"

Gire el manillar a la derecha o a la izquierda. Empujar levemente la llave y al mismo tiempo girarla en posición "LOCK".

Todos los circuitos eléctricos están desactivados y el manillar está bloqueado. Se puede extraer la llave.

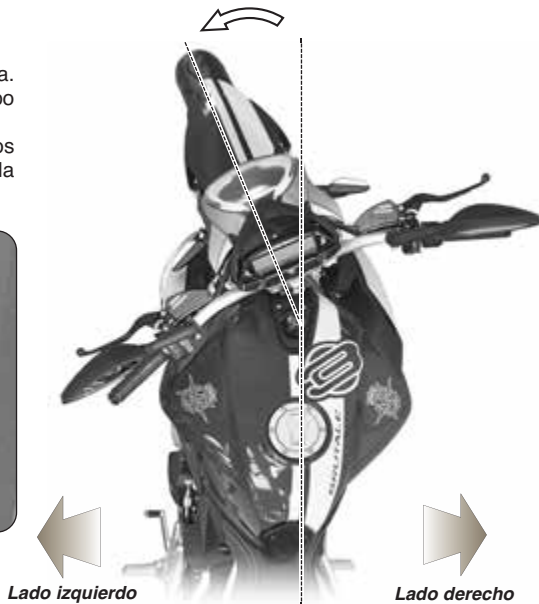



### 3.6. Mando cambio

La posición **N** “Neutral” corresponde a la posición de punto muerto señalada por el correspondiente testigo en el cuadro mandos. Desplazando la palanca del cambio hacia abajo se engrana la primera velocidad. De igual manera, desplazando la palanca hacia arriba se engrana la segunda; continuando varias veces a desplazar la palanca hacia arriba se engranan, en secuencia, todas las demás velocidades hasta la sexta.

#### ❑ Función “Quick Shift”

Los modelos Brutale están equipados con un sistema de cambio rápido de velocidad (“Quick Shift”); este dispositivo permite de engranar las velocidades superiores o inferiores sin tener que tirar el embrague o cambiar el ángulo del mando del acelerador. De esta manera, es posible engranar velocidades superiores o inferiores manteniendo una aceleración constante y reduciendo el tiempo de cambio a un mínimo.



**CUIDADO:** El sistema “Quick Shift” no está disponible en las siguientes condiciones:

- cuando se cambia velocidad con la palanca del embrague presionada;
- cuando el vehículo se desplaza a una velocidad inferior a 30 km/h;
- si la palanca del cambio no está en su posición correcta al cambiar de marcha.

Además, durante la conducción del vehículo con el motor de altas revoluciones y en una marcha baja, cambiar la velocidad sin accionar la palanca del embrague puede causar reacciones bruscas, que pueden poner en peligro la estabilidad del vehículo. MV Agusta recomienda para tirar la palanca de embrague en todas las circunstancias antes mencionadas, especialmente cuando la velocidad del motor está cerca de la velocidad de intervención del limitador.





## 3.7. Instrumentación y testigos

Los instrumentos y los testigos se activan girando la llave de encendido en posición "ON". Después de un check-up inicial (~7 segundos) la información que aparece corresponde a las condiciones generales de la motocicleta en ese momento.

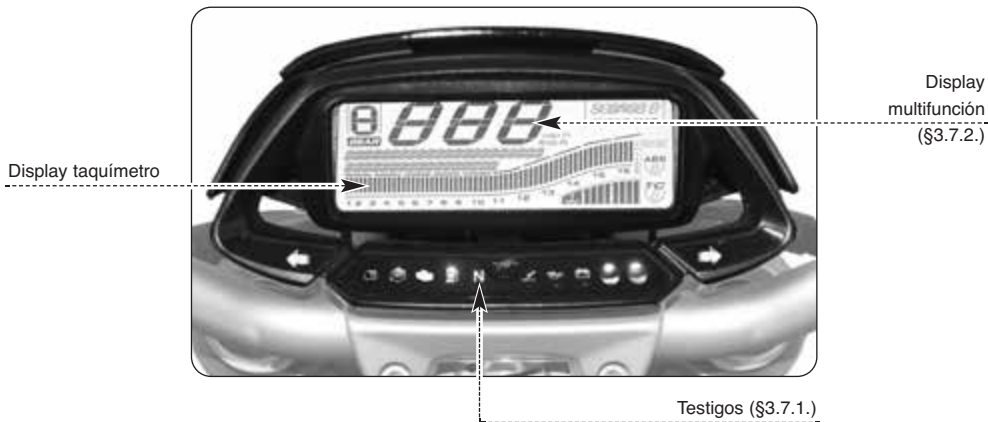



### 3.7.1. Testigos

#### Testigo ABS (rojo)

Se ilumina cuando el sistema ABS tiene una avería o está desactivado, o si la velocidad es inferior a 5 km/h.

 **Peligro-Atención:** Si se enciende durante la circulación, deténgase inmediatamente y compruebe que el sistema ABS está activado (ver §4.4.6.). En este caso, volver a la marcha a baja velocidad y contactar con un centro de asistencia autorizado MV Agusta.

#### Testigo luz carretera (azul)

Se enciende cuando está activada la luz de carretera.

#### Testigo del motor (naranja)

Se enciende cuando se verifica un mal funcionamiento del motor.

#### Testigo reserva combustible (naranja)

Se enciende cuando en el depósito hay aproximadamente cuatro litros de combustible.

#### Testigo cambio en punto muerto (verde)

Se enciende cuando el cambio está en la posición de punto muerto "Neutral".

#### Testigo apertura caballete lateral (rojo)

Se enciende cuando el caballete está bajado.

#### Testigo presión aceite motor (rojo)

Se enciende cuando el aceite está a una presión insuficiente.

 **Peligro-Atención:** Si se enciende durante la circulación, deténgase inmediatamente, controle el nivel del aceite y si es necesario hace efectuar el relleno por un centro de asistencia autorizado MV Agusta (ver §3.8.). Si el testigo se enciende a pesar de que el nivel es correcto, no siga circulando y póngase en contacto con un centro de asistencia autorizado MV Agusta.

#### Testigos indicadores dirección (verde)

Se encienden cuando están activados los indicadores de dirección.

#### Indicador limitador rev. (rojo)

Se enciende antes de la intervención del limitador, con un número de revoluciones que depende de la relación del cambio. El limitador interviene a 13000 rpm.

#### Testigo "Warning" (naranja)

Se enciende cuando se verifica un desperfecto. Si el encendido se produce durante la conducción, en contacto con un centro de servicio autorizado.

#### Testigo carga batería (rojo)

Se enciende cuando el alternador no proporciona la corriente eléctrica suficiente para cargar la batería.

Si el encendido se produce durante la circulación, dirijase a un centro de asistencia autorizado.

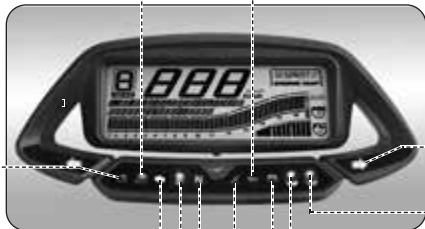



## 3.7.2. Pantalla multifunción

### Velocímetro

Indica la velocidad en kilómetros por hora (Km/h) o en millas por hora (Mph). El máximo valor (fondo de escala) es de 300 Km/h (186 Mph).

### Pantalla relación de marcha

Indica la relación correspondiente a la marcha embragada. La cifra "0" indica que el cambio se encuentra en punto muerto.

### Cuenta kilómetros total "TOTAL"

Indica la distancia total recorrida; entre 0 y 999999 (Km o millas).

### Cuenta kilómetros parcial 1 "TRIP 1"

Indica la distancia parcial recorrida; entre 0 y 999.9 (Km o millas).

### Cuenta kilómetros parcial 2 "TRIP 2"

Indica la distancia parcial recorrida; entre 0 y 999.9 (Km o millas).

### Cronómetro

Indica los tiempos medidos con la función "Cronómetro".

### Pantalla ABS

Indica el estado de activación de la función ABS.

### Pantalla del nivel de control de tracción

Indica el nivel del control de tracción actualmente seleccionado.

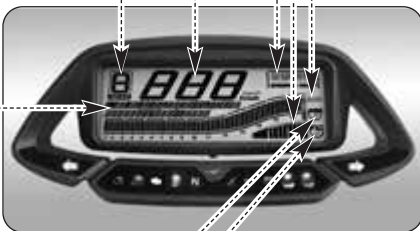

### Pantalla mapa centralita

Indica la mapa de la centralita actualmente seleccionada.

### Reloj

Indica el horario actual.

### Termómetro

El número de segmentos iluminados sobre una escala graduada le permitirá conocer la temperatura del líquido refrigerante. Cuando la temperatura se encuentre fuera del intervalo de valores normales admisibles podrá visualizar una de las siguientes indicaciones:

- un solo segmento intermitente: temperatura baja;
- todos los segmentos iluminados y el segmento superior intermitente: temperatura alta.



**Peligro - Cuidado:** En caso de alta temperatura, detenga la motocicleta y controle el nivel del líquido refrigerante. Si debe rellenarse a nivel, diríjase a un Centro de Asistencia MV Agusta autorizado (ver § 3.8). Si la indicación persiste a pesar de que el nivel es correcto, detenga la motocicleta y contacte con un Centro de Asistencia MV Agusta autorizado.

**3.8. Tabla de lubricantes y líquidos**

<i>Descripción</i>	<i>Producto aconsejado</i>	<i>Características</i>
Aceite lubricación motor	Motul 7100 4T 5W40 (*)	SAE 5W/40
Líquido de refrigeración	Motul Motocool Factory Line	Producto basado en monoetilenglicol - Listo para usar - No añadir agua
Fluido mando embrague y frenos	Motul DOT 3 & 4 Brake Fluid	DOT4
Aceite lubricación cadena	Motul Chain Lube Road	-

\* : Para encontrar fácilmente los productos recomendados, MV Agusta aconseja dirigirse directamente a los propios concesionarios autorizados. El motor de la motocicleta Brutale ha sido desarrollado con el aceite para motor Motul 7100 4T 5W40. En el caso que el lubricante descrito no se consiga, MV Agusta aconseja utilizar aceites completamente sintéticos con características conformes o superiores a las siguientes normas:

- Conforme API SN / SM
- Conforme JASO MA2
- Gradación SAE 5W40

**NOTA**

Las especificaciones indicadas deben estar presentes, por sí solas o junto a otras, en el envase del aceite lubricante.





#### 4.1. Uso de la motocicleta

En esta sección se exponen los principales temas para el correcto uso de la motocicleta.



##### **CUIDADO**

Su motocicleta Brutale tiene altas características de potencia y prestaciones; por lo tanto, para su utilización es necesario un adecuado nivel de conocimiento del vehículo. Cuando usted utiliza la motocicleta para la primera vez, es necesario adoptar una actitud prudente. Una agresiva o temeraria actitud de conducción podría aumentar el peligro de accidentes y comportar un grave peligro para su incolumidad o para la de otras personas.



##### **CUIDADO**

**LAS RESTRICCIONES DE USO DEL VEHÍCULO ESTÁN INDICADAS EN LA SECCIÓN “INFORMACIÓN PARA LA SEGURIDAD”.**





## 4.2. Rodaje



**Cautela - Precaución: No respetar las instrucciones que siguen puede resultar en detrimento de las prestaciones de su motocicleta y/o de su vida útil.**

Es muy común pensar que la importancia del rodaje radique exclusivamente en el motor. En realidad, el rodaje es fundamental también para otros componentes vitales de la motocicleta como los neumáticos, los frenos y la cadena de transmisión, entre otros. Durante los primeros kilómetros conduzca con moderación.

### Entre 0 y 500 Km (entre 0 y 300 millas) (A)

Varié frecuentemente el régimen del motor. Siempre que sea posible, recorra caminos con ligeras colinas y muchas curvas, evitando largos tramos rectilíneos.



### CUIDADO

Los neumáticos deben someterse a un rodaje adecuado para poder responder eficientemente a las exigencias futuras. Evite aceleraciones, curvas y frenadas bruscas durante los primeros 100 km. Si los neumáticos no se someten a un correcto rodaje inicial, podrá enfrentarse al riesgo de resbalar y/o de perder el control del vehículo en el futuro, con el consiguiente peligro de accidentes.



**Entre 500 y 1000 Km (entre 300 y 600 millas)**

Evite someter el motor a esfuerzos prolongados.



**Entre 1000 y 2500 Km (entre 600 y 1600 millas)**

Puede esperar una prestación mayor del motor sin por ello exceder el régimen indicado.





### 4.3. Arranque



**CUIDADO:** Dejar el motor en marcha en un ambiente cerrado puede ser peligroso. Los gases de escape contienen monóxido de carbono, un gas incoloro e inodoro que puede provocar la muerte o lesiones serias. Encienda y mantenga el motor en marcha sólo en lugares abiertos y/o al aire libre.

▶ Al girar el interruptor de encendido hasta la posición "ON", la instrumentación y los pilotos ejecutarán una secuencia de auto-diagnóstico preliminar: compruebe que se iluminen todos los pilotos del tablero durante esta inicialización.

▶ Para que el sistema del circuito de encendido genere la señal de arranque del motor deberá satisfacerse una de las siguientes condiciones:

- Cambio en punto muerto y palanca de cambio en posición de embragado.
- Una marcha embragada, palanca de cambio en posición de embragado a fondo y caballete lateral levantado.

**NOTA:** Cuando faltan menos de 1.000 KM para la ejecución de la próxima intervención de mantenimiento programada, en la pantalla aparece el aviso que se muestra al lado.





► Si el auto-diagnóstico detecta la presencia de una avería en el vehículo, la pantalla muestra el mensaje de error mostrado en la figura. En particular, la pantalla muestra la parte del vehículo en el que se ha detectada la avería.



► Presionando ahora el pulsador “OK”, se accede a la función “RUN”.

**CUIDADO**

Si se detecta una avería en el vehículo, no arranque el motor y póngase en contacto con un centro de asistencia autorizado MV Agusta.





#### ❑ Procedimiento de arranque

- ▶ Presione el botón para arrancar el motor sin girar el mando del acelerador.
- ▶ Suelte el botón apenas el motor se ponga en marcha.



#### Cautela - Precaución:

- Nunca accione el arranque por más de 5 segundos consecutivos para evitar dañar la instalación eléctrica.
- Nunca deje el motor en marcha durante mucho tiempo con la motocicleta parada: pueden dañarse los componentes internos del motor debido al recalentamiento. Es preferible alcanzar la temperatura de régimen circulando a baja velocidad.
- Para prolongar el máximo posible la vida útil del motor, nunca acelere a fondo con el motor en frío.

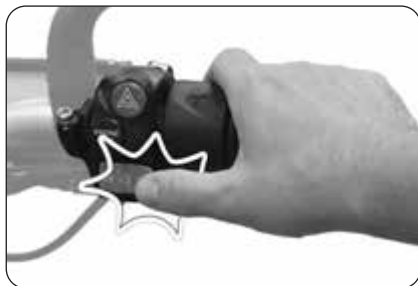



#### 4.4. Selección y modificación de las funciones de la pantalla

La instrumentación de su motocicleta le permite seleccionar y modificar algunos parámetros principales de medición tal como se describe a continuación:

- Selección de funciones:
  - “RUN” (Cuenta kilómetros)
  - “SPEED LIMITER” (Limitador de velocidad)
  - “TC” (Control de tracción)
  - “CHRONO” (Cronómetro)
  - “ABS” (Sistema de antibloqueo de frenos)
  - “QUICK SHIFT” (Cambio rápido de marcha)
  - “CLOCK” (Reloj)
- Reset de las funciones cuenta kilómetros parciales:
  - Cuenta kilómetros Parcial 1 “TRIP 1”
  - Cuenta kilómetros Parcial 2 “TRIP 2”
- Activación de la función cronómetro
- Configuración del reloj
- Función “IMMOBILIZER” (Sistema anti-roboto)
- Selección del mapeado de la central





#### 4.4.1. Selección de las funciones de la pantalla

Puede seleccionar las siguientes funciones:

- “RUN” (Cuenta kilómetros)
- “SPEED LIMITER” (Limitador de velocidad)
- “TC” (Control de tracción)
- “CHRONO” (Cronómetro)
- “ABS” (Sistema de antibloqueo de frenos)
- “QUICK SHIFT” (Cambio rápido de marcha)
- “CLOCK” (Reloj)

Presione la tecla “SET” menos de 4 segundos para poder visualizar las diversas funciones una a la vez. Si presiona la tecla por más de 3 segundos, visualizará todas las funciones, una luego de la otra. Seleccionar la función deseada.



#### **CUIDADO:**

Las funciones del display deben seleccionarse y modificarse con el motor apagado, en punto muerto, con la motocicleta detenida y los pies apoyados en el suelo. Queda terminantemente prohibido programar las funciones durante la marcha, excepto cuando se indique lo contrario.



### ❑ Función “RUN”

Además de la función de taquímetro, podrá visualizar en el display las funciones que siguen (ver §4.4.2.):

- Cuenta kilómetros Total “TOTAL”
- Cuenta kilómetros Parcial 1 “TRIP 1”

En alternativa:

- Cuenta kilómetros Total “TOTAL”
- Cuenta kilómetros Parcial 2 “TRIP 2”

### ❑ Función “SPEED LIMITER”

Le permite adaptar la velocidad máxima del vehículo en función de sus exigencias de conducción (ver §4.4.3.).







#### ❑ Función “TC”

Le permite adaptar el nivel de control de la tracción del motor en función de sus exigencias de conducción (ver §4.4.4.).



#### ❑ Función “CHRONO”

Le permite activar el cronómetro y salvar los datos medidos (ver §4.4.5.). Las opciones visualizadas serán:

- Cronómetro Vuelta en curso “CURRENT LAP”
- Cronómetro Mejor vuelta recorrida “BEST LAP”
- Cronómetro Vuelta anterior “LAST LAP”
- Taquímetro Total de vueltas recorridas “N° LAP”





#### ❑ Función “ABS”

Le permite activar o desactivar el sistema antibloqueo de frenos (ABS) (ver §4.4.6.).



#### ❑ Función “QUICK SHIFT”

Le permite apagar o encender la función del cambio rápido de marcha (ver § 4.4.7.).





#### ❑ Función “CLOCK”

Esta función permite modificar el horario (horas y minutos) indicado en el salpicadero (ver §4.4.8.).





#### 4.4.2. Reset de las funciones cuenta kilómetros parciales

Para resetear las funciones “TRIP 1” y “TRIP 2” siga los pasos descritos a continuación.



#### **CUIDADO**

Las funciones del display deben seleccionarse y modificarse con el motor apagado, en punto muerto, con la motocicleta detenida y los pies apoyados en el suelo. Queda terminantemente prohibido programar las funciones durante la marcha.

- ▶ Acceder a la función “RUN”; en la pantalla inicial se visualizan las funciones cuentakilómetros total (“TOTAL”) y cuentakilómetros parcial 1 (“TRIP 1”).
- ▶ Presionando ahora el pulsador “OK” durante un tiempo superior a tres segundos el valor “TRIP 1” se ajusta a cero.





► Presionar el pulsador “OK” durante un tiempo inferior a tres segundos hasta la visualización de la función cuentakilómetros parcial 2 (“TRIP 2”).



► Presionando ahora el pulsador “OK” durante un tiempo superior a tres segundos el valor “TRIP 2” se ajusta a cero.





#### 4.4.3. Función "SPEED LIMITER"

Al arrancar el motor, la función "SPEED LIMITER" está desactivada. Para activarla, es necesario realizar las siguientes operaciones:

- ▶ Presione "SET" para acceder a la función "SPEED LIMITER". El valor de la velocidad máxima que se muestra en la pantalla (igual a la velocidad actual del vehículo) comienza a parpadear.

**NOTA:** La velocidad máxima se puede seleccionar y modificar también durante el uso del vehículo.

- ▶ Presione "SET" por menos de tres segundos: el valor de la velocidad máxima se reduce de **2 km/h** respecto al valor mostrado en la pantalla. De lo contrario, presionando "OK" por menos de tres segundos, el valor de la velocidad máxima se incrementa de **2 km/h** respecto al valor mostrado en la pantalla.





- ▶ Presione “OK” por más de tres segundos para confirmar el valor seleccionado de la velocidad máxima. La cifra que aparece en la pantalla deja de parpadear y la pantalla vuelve a la función “RUN”.
- ▶ De lo contrario, presionando “SET” por más de tres segundos, la función “SPEED LIMITER” está desactivada. Después de tres segundos, la pantalla vuelve a la función “RUN”.

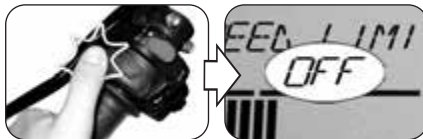

- ▶ Si la función “SPEED LIMITER” está activada, durante la conducción del vehículo, el valor de la velocidad mostrado en el velocímetro comienza a parpadear cuando se alcanza el valor fijado de la velocidad máxima.



#### 4.4.4. Función “TC”

► Presione “SET” para acceder a la función “TC”, luego presione “OK” por menos de tres segundos hasta visualizar “TC LEVEL”: el nivel de tracción efectivo corresponde al valor visualizado en el display.



#### NOTA

**El nivel de control de la tracción se puede seleccionar y modificar también durante el uso del vehículo.**

► Presione “OK” por menos de tres segundos: el nivel de control de la tracción alcanza el valor sucesivo. De lo contrario, presionando “SET” por menos de tres segundos, el nivel de control de la tracción disminuye al valor más bajo. Intervalo de variación admisible: entre **0** y **8**.

► Presione “SET” por más de tres segundos para confirmar el nivel de control de tracción seleccionado.







#### 4.4.5. Cronómetro

##### ❑ Adquisición de los tiempos de recorrido de la vuelta

▶ Active la función cronómetro (“CHRONO”) para que el sistema inicie a adquirir los datos correspondientes a los tiempos de recorrido de la vuelta.

▶ Basta presionar el mando de la luz larga para que el sistema inicie la ejecución de la función: los dos puntos que separan los minutos, los segundos y las décimas de segundo pasan al estado intermitente, indicando que el sistema está adquiriendo los datos relativos a los tiempos.

**NOTA:** Cuando la función “CHRONO” está activada, la primera presión del mando de la luz larga activa automáticamente la función “TC”. Desde este momento, es posible modificar el nivel de control de tracción presionando los botones “SET” and “OK” (ver § 4.4.4.).





► Presione nuevamente el mando de la luz larga para adquirir el tiempo correspondiente a la primera vuelta recorrida: el instrumento empezará a adquirir contemporáneamente el tiempo correspondiente a la segunda vuelta.

La medición del tiempo relativo a la primera vuelta se conserva en memoria y permanece visualizada en el display durante diez segundos, luego se visualiza el tiempo de la vuelta sucesiva.

► Cada vez que presione el mando de la luz larga el sistema salvará un tiempo en su memoria. Este instrumento puede memorizar un máximo de 100 datos consecutivos.

Durante la visualización del tiempo de la vuelta apenas acabada, en el display aparece el símbolo “+” o bien “-” en el caso en que el tiempo medido sea respectivamente inferior o superior al tiempo medido durante la vuelta anterior.





### ❑ Visualización de datos

Una vez que el sistema haya completado la fase de adquisición de datos podrá visualizar los tiempos en el display.

► Acceder a la función “CHRONO”; en esta pantalla se visualiza el tiempo de la vuelta más rápida (“BEST LAP”) y el tiempo de la última vuelta efectuada (“LAST LAP”).



#### **CUIDADO:**

Las funciones del display deben seleccionarse y modificarse con el motor apagado, en punto muerto, con la motocicleta detenida y los pies apoyados en el suelo. Queda terminantemente prohibido programar las funciones durante la marcha.

► Presione “OK” por menos de tres segundos hasta visualizar “LAPS VIEW”.





► La presión repetida del pulsador de ráfagas del faro de luz larga permite visualizar en secuencia todos los tiempos anteriormente adquiridos a partir de la última vuelta memorizada.

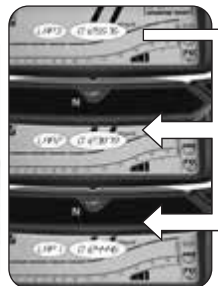

► Al final de la visualización de los datos, la presión del pulsador "SET" permite regresar a la función "LAPS VIEW" para pasar a la función sucesiva.





### ❑ Cómo borrar los datos

Para borrar los datos adquiridos siga los pasos descritos a continuación:



#### **CUIDADO:**

Las funciones del display deben seleccionarse y modificarse con el motor apagado, en punto muerto, con la motocicleta detenida y los pies apoyados en el suelo. Queda terminantemente prohibido programar las funciones durante la marcha.

▶ *Cancelación tiempos individuales:* Acceder a la función "CHRONO" y presionar el pulsador "SET" durante un tiempo inferior a tres segundos hasta la visualización del texto "SINGLE LAP RESET".

▶ Presionar el pulsador "OK" durante un tiempo inferior a tres segundos; el valor del último tiempo de la vuelta memorizada empieza a centellear.





► Presione “OK” por más de tres segundos para borrar el dato. Si presiona “SET” por menos de tres segundos, se interrumpirá la ejecución de borrado.

► Sucesivamente, la presión del pulsador de ráfagas del faro de luz larga seguida por la presión del pulsador “OK” durante un tiempo superior a tres segundos permite cancelar en secuencia todos los tiempos anteriormente adquiridos.

► Al final de la cancelación de los datos, la presión del pulsador “SET” permite regresar a la función “SINGLE LAP RESET” para pasar a la función sucesiva.

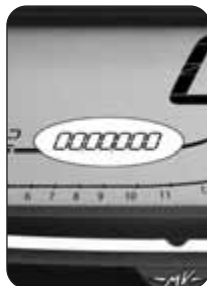



► *Cancelación mejor tiempo:* Acceder a la función “CHRONO” y presionar el pulsador “SET” durante un tiempo inferior a tres segundos hasta la visualización del texto “BEST LAP RESET”.



► Presionar el pulsador “OK” durante un tiempo inferior a tres segundos; el valor del tiempo de la vuelta más rápida inicia a centellear.





► Presione “OK” por más de tres segundos para borrar el dato. Si presiona “SET” por menos de tres segundos, se interrumpirá la ejecución de borrado.

► Al final de la cancelación de los datos, la presión del pulsador “SET” permite salir de la función “BEST LAP RESET” para pasar a la modalidad sucesiva.

► *Cancelación de todos los tiempos memorizados:* Acceder a la función “CHRONO” y presionar el pulsador “SET” durante un tiempo inferior a tres segundos hasta la visualización del texto “ALL LAPS RESET”.

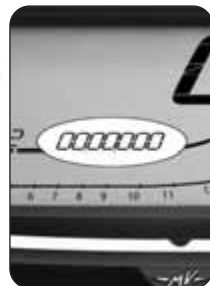





► Presionar el pulsador “OK” durante un tiempo inferior a tres segundos; el display solicita la confirmación para la cancelación de todos los datos presentes en memoria.



► Presionando ahora el pulsador “OK” durante un tiempo superior a tres segundos todos los tiempos anteriormente adquiridos son cancelados. Si por el contrario se presiona el pulsador “SET” durante un tiempo inferior a tres segundos el procedimiento de cancelación se interrumpe.



► Al final de la cancelación de los datos, la presión del pulsador “SET” permite salir de la función “ALL LAPS RESET” para regresar a la modalidad “CHRONO”.



#### 4.4.6. Selección de las funciones ABS

► Presione “SET” para acceder a la función “ABS”; “SETTING ABS” aparece en el display.



#### **CUIDADO**

Las funciones del display deben seleccionarse y modificarse con el motor apagado, en punto muerto, con la motocicleta detenida y los pies apoyados en el suelo. Queda terminantemente prohibido programar las funciones durante la marcha.

► Presione “OK” menos de tres segundos: “ABS ON” empieza a parpadear en el display.

► Si no se presiona ningún botón, después de tres segundos la selección “ABS ON” está confirmada; en esta condición, el sistema ABS está activado. Presione “SET” para salir de la función “ABS”.





- ▶ De lo contrario, si se presiona “OK” mientras que el título sigue parpadeando, “ABS OFF” aparece en el display.
- ▶ Si no se presiona ningún botón, después de tres segundos la selección “ABS OFF” está confirmada; en esta condición, el sistema ABS está desactivado. Presione “SET” para salir de la función “ABS”.

**CUIDADO**

Si el sistema ABS está desactivado, la luz de advertencia correspondiente en el tablero de instrumentos se enciende (ver § 3.7.1.). Desde este momento, el sistema de antibloqueo de frenos no es disponible durante el frenado. Adoptar un estilo de conducción prudente y viajar a baja velocidad, para no perder el control del vehículo durante una frenada de emergencia.





#### 4.4.7. Función “QUICK SHIFT”

► Presione “SET” para acceder a la función “QUICK SHIFT”. La pantalla muestra el estado de activación actual de la función del cambio rápido de marcha.



#### **CUIDADO**

Las funciones del display deben seleccionarse y modificarse con el motor apagado, en punto muerto, con la motocicleta detenida y los pies apoyados en el suelo. Queda terminantemente prohibido programar las funciones durante la marcha.

► Presione “OK” por menos de tres segundos; la leyenda de la activación del cambio rápido comienza a parpadear.

► Presionando “OK” por menos de tres segundos, cambia el título de “OFF” en “ON” y viceversa.

► Presione “SET” para confirmar el estado seleccionado de activación del cambio rápido.





#### 4.4.8. Configuración del reloj

► Para efectuar la configuración del reloj, apretar el pulsador “SET” hasta que se vea el mensaje “CLOCK SETTING”.



#### CUIDADO

Las funciones del display deben seleccionarse y modificarse con el motor apagado, en punto muerto, con la motocicleta detenida y los pies apoyados en el suelo. Queda terminantemente prohibido programar las funciones durante la marcha.

► Apretar el pulsador “OK” durante un tiempo inferior a tres segundos; la cifra de la hora comienza a parpadear.

► Apretar de nuevo el pulsador “OK” durante un tiempo inferior a tres segundos, la cifra de la hora aumenta pasando al valor siguiente.

► Apretar el pulsador “OK” durante un tiempo inferior a tres segundos; se confirma la cifra de la hora elegida. En cambio, si se aprieta el pulsador “SET” durante un tiempo inferior a tres segundos, se interrumpe el procedimiento de configuración.

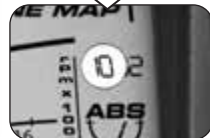
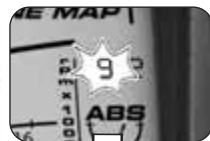



- ▶ Después de haber efectuado la configuración de la cifra de la hora, el salpicadero pasa automáticamente a la configuración de la cifra de los minutos. La cifra de los minutos comienza a parpadear.
- ▶ Apretar el pulsador "OK" durante un tiempo inferior a tres segundos; la cifra de los minutos aumenta pasando al valor siguiente.
- ▶ Apretar el pulsador "OK" durante un tiempo superior a tres segundos; se confirma la cifra de los minutos hora elegida y el salpicadero vuelve a la modalidad "CLOCK". En cambio, si se aprieta el pulsador "SET" durante un tiempo inferior a tres segundos, se interrumpe el procedimiento de configuración.

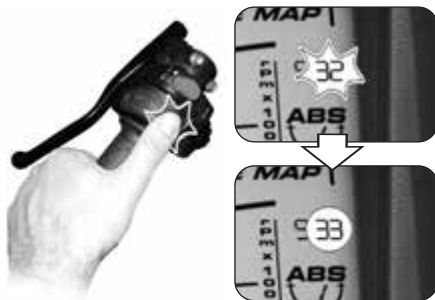



#### 4.4.9. Función “IMMOBILIZER”

La función “IMMOBILIZER” le permite poner el motor en marcha sólo si el sistema reconoce la llave de arranque original. Se trata de un sistema anti-roboto integrado al circuito electrónico del vehículo que impide que una persona no autorizada la ponga en marcha.

La función “IMMOBILIZER” debe utilizarse sólo en caso de anomalía: si por cualquier motivo el sistema no lograse reconocer la llave original, para poder poner en marcha su motocicleta deberá introducir entonces el código secreto indicado en la “MV Code Card” entregada junto con el vehículo.

- ▶ Quite la cubierta del recuadro posterior de la “MV Code Card” y lea el código electrónico secreto de su llave de puesta en marcha (la figura indica un código indicativo que puede no corresponder al de su llave).
- ▶ Acceder a la función “RUN” y presionar “SET” por más de 10 segundos hasta visualizar “IMMOBILIZER”.



**CUIDADO**

Las funciones del display deben seleccionarse y modificarse con el motor apagado, en punto muerto, con la motocicleta detenida y los pies apoyados en el suelo. Queda terminantemente prohibido programar las funciones durante la marcha.

- ▶ Presione "OK" menos de 3 segundos para programar la primera cifra del código.
- ▶ Presionando "OK" menos de 3 segundos podrá modificar la primera cifra entre **0** y **9**.
- ▶ Una vez que haya seleccionado la primera cifra presione "OK" por más de 3 segundos para confirmarla antes de pasar a la segunda.
- ▶ Repita estos pasos para introducir las tres cifras restantes del código.

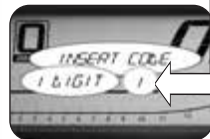





► Una vez que haya introducido todas las cifras del código visualizará en el display el mensaje “CONFIRM CODE”. Presione “OK” por más de 3 segundos para confirmar el código que ha introducido.



► Si el sistema reconoce el código, visualizará en el display el mensaje “VALID CODE”. El instrumento volverá entonces a la función “RUN”, permitiéndole arrancar el motor.

► Si el código introducido es incorrecto, visualizará en el display el mensaje “NOT VALID CODE”: el sistema no le permitirá arrancar el motor y volverá a la función “IMMOBILIZER”. Repita todos los pasos anteriores para introducir el código secreto correcto indicado en su MV Code Card. En caso de inconvenientes, contacte con un Centro de Asistencia MV Agusta autorizado.





#### 4.4.10. Selección del mapeado de la central

En los modelos Brutale, se puede seleccionar diferentes mapas de la centralita que permiten obtener características variables de potencia y prestaciones dependiendo del tipo de utilización del vehículo.

##### NOTA

**El mapeado de la central se puede seleccionar también durante el uso del vehículo.**

La selección del mapeado de la centralita se puede efectuar presionando el pulsador en el lado derecho del manillar; de esta manera el mapeado pasa al valor siguiente. Las relativas características del mapeado se indican en la siguiente tabla.

Mapeado	N	R	S	C
Modalidad	Normal	Lluvia	Deportivo	Personalizado





#### ❑ Ajuste del mapeado personalizado

► Presionar el pulsador “ENGINE MAP” hasta la selección del mapeado “C” de la centralita (mapeado personalizado).



**CUIDADO:** El ajuste del mapeado personalizado se debe seleccionar en punto muerto, con la motocicleta detenida y los pies apoyados en el suelo. Queda terminantemente prohibido programar las funciones durante la marcha.

► Presionar el pulsador “SET” hasta que “SETTING CUSTOM MAP” aparece.

A fin de ajustar los parámetros del mapeado personalizado a sus necesidades de conducción, realizar las siguientes operaciones.

**NOTA:** El mapeado personalizado se puede crear mediante la mezcla de las características de los mapeados “Normal”, “Lluvia” y “Deportivo” cuando se definen los siguientes parámetros.

► *Sensibilidad del control del acelerador:* Apretar el pulsador “OK” durante un tiempo inferior a tres segundos hasta que “GAS SENSITIVITY” aparece.





► Apretar el pulsador “SET” durante un tiempo inferior a tres segundos. La pantalla muestra la configuración actual de la sensibilidad del control del acelerador.



► Apretar el pulsador “OK” durante un tiempo inferior a tres segundos; el ajuste mostrado comienza a parpadear.

► La presión repetida del pulsador “OK” durante un tiempo inferior a tres segundos, permite visualizar en secuencia las siguientes configuraciones:

- “NORMAL” (Normal)
- “RAIN” (Lluvia)
- “SPORT” (Deportiva)

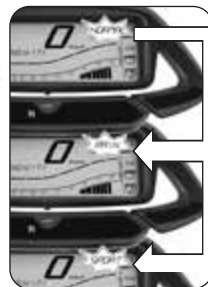



► Apretar el pulsador “OK” durante un tiempo superior a tres segundos; el nuevo ajuste será confirmado. El ajuste mostrado deje de parpadear, y después de algunos segundos la pantalla vuelve a la modalidad “GAS SENSITIVITY”. Ahora es posible proceder con el ajuste del parámetro siguiente.



► *Par máximo del motor:* Apretar el pulsador “OK” durante un tiempo inferior a tres segundos hasta que “MAX ENGINE TORQUE” aparece.





► Apretar el pulsador “SET” durante un tiempo inferior a tres segundos. La pantalla muestra la configuración actual del par máximo del motor.



► Apretar el pulsador “OK” durante un tiempo inferior a tres segundos; el ajuste mostrado comienza a parpadear.

► La presión repetida del pulsador “OK” durante un tiempo inferior a tres segundos, permite visualizar en secuencia las siguientes configuraciones:

- “RAIN” (Lluvia)
- “SPORT” (Deportiva)





► Apretar el pulsador “OK” durante un tiempo superior a tres segundos; el nuevo ajuste será confirmado. El ajuste mostrado deja de parpadear, y después de algunos segundos la pantalla vuelve a la modalidad “MAX ENGINE TORQUE”.



► *Freno motor:* Apretar el pulsador “OK” durante un tiempo inferior a tres segundos hasta que “ENGINE BRAKE” aparece.





► Apretar el pulsador “SET” durante un tiempo inferior a tres segundos. La pantalla muestra la configuración actual del freno motor.



► Apretar el pulsador “OK” durante un tiempo inferior a tres segundos; el ajuste mostrado comienza a parpadear.

► La presión repetida del pulsador “OK” durante un tiempo inferior a tres segundos, permite visualizar en secuencia las siguientes configuraciones:

- “NORMAL” (Normal)
- “SPORT” (Deportiva)







► Apretar el pulsador “OK” durante un tiempo superior a tres segundos; el nuevo ajuste será confirmado. El ajuste mostrado deja de parpadear, y después de algunos segundos la pantalla vuelve a la modalidad “ENGINE BRAKE”.



► *Respuesta del motor:* Apretar el pulsador “OK” durante un tiempo inferior a tres segundos hasta que “ENGINE RESPONSE” aparece.





► Apretar el pulsador “SET” durante un tiempo inferior a tres segundos. La pantalla muestra la configuración actual de la respuesta del motor.



► Apretar el pulsador “OK” durante un tiempo inferior a tres segundos; el ajuste mostrado comienza a parpadear.

► La presión repetida del pulsador “OK” durante un tiempo inferior a tres segundos, permite visualizar en secuencia las siguientes configuraciones:

- “SLOW” (Respuesta lenta)
- “FAST” (Respuesta rápida)





► Apretar el pulsador “OK” durante un tiempo superior a tres segundos; el nuevo ajuste será confirmado. El ajuste mostrado deje de parpadear, y después de algunos segundos la pantalla vuelve a la modalidad “ENGINE RESPONSE”.



► *Limitador revoluciones del motor:* Apretar el pulsador “OK” durante un tiempo inferior a tres segundos hasta que “RPM LIMITER” aparece.





► Apretar el pulsador “SET” durante un tiempo inferior a tres segundos. La pantalla muestra la configuración actual del limitador de revoluciones del motor.



► Apretar el pulsador “OK” durante un tiempo inferior a tres segundos; el ajuste mostrado comienza a parpadear.

► La presión repetida del pulsador “OK” durante un tiempo inferior a tres segundos, permite visualizar en secuencia las siguientes configuraciones:

- “NORMAL” (Normal)
- “SPORT” (Deportiva)





► Apretar el pulsador “OK” durante un tiempo superior a tres segundos; el nuevo ajuste será confirmado. El ajuste mostrado deje de parpadear, y después de algunos segundos la pantalla vuelve a la modalidad “RPM LIMITER”.



► Apretar el pulsador “OK” durante un tiempo inferior a tres segundos hasta que la pantalla vuelve a la modalidad “RUN”. El ajuste del mapeado personalizado se ha completado.





#### 4.4.11. Mensajes de advertencia/error

La pantalla puede mostrar un error o un mal funcionamiento en las diferentes condiciones de utilización del vehículo.

► *Arranque del motor:* Al girar el interruptor de encendido hasta la posición "ON", la instrumentación y los pilotos ejecutarán una secuencia de auto-diagnóstico preliminar. Si el auto-diagnóstico detecta la presencia de una avería en el vehículo, la pantalla muestra el mensaje de error mostrado en la figura. En particular, la pantalla muestra la parte del vehículo en el que se ha detectada la avería.

► Presionando ahora el pulsador "OK", se accede a la función "RUN". Las luces de emergencia de los indicadores de dirección comienzan a parpadear.



#### **CUIDADO**

**Si se detecta una avería con el vehículo parado, no arranque el motor y póngase en contacto con un centro de asistencia autorizado MV Agusta.**





► *Marcha del vehículo:* Si se detecta una avería en la conducción del vehículo, la parte inferior de la pantalla muestra el mensaje de error mostrado en la figura. Las luces de emergencia de los indicadores de dirección comienzan a parpadear.

**CUIDADO**

Si se detecta una avería en la marcha, detener el vehículo y póngase en contacto con un centro de asistencia autorizado MV Agusta.

ES 4

► Cuando el vehículo está detenido, la pantalla muestra la parte del vehículo en el que se ha detectada la avería.





► *Alta temperatura del líquido refrigerante:* Si se detecta una alta temperatura del líquido refrigerante, la pantalla muestra el mensaje de error mostrado en la figura. Este mensaje puede aparecer durante todas las condiciones de uso del vehículo.

**CUIDADO**

En caso de alta temperatura, detenga la motocicleta y controle el nivel del líquido refrigerante. Si debe rellenarse a nivel, diríjase a un Centro de Asistencia MV Agusta autorizado (ver § 3.8). Si la indicación persiste a pesar de que el nivel es correcto, detenga la motocicleta y contacte con un Centro de Asistencia MV Agusta autorizado.







#### 4.5. Abastecimiento combustible



**Peligro – Atención:** la gasolina y sus vapores son extremadamente inflamables y dañosos. Evitar el contacto y la inhalación.

Durante el abastecimiento apagar el motor, no fumar, tener lejos llamas, chispas y fuentes de calor. Efectuar el llenado en un lugar abierto o en un sitio bien ventilado.



**Prudencia – Precaución:** Utilizar exclusivamente combustible que tenga las siguientes características:

- Gasolina sin plomo
- Contenido de etanol: hasta 10% de volumen
- Número de octano (R.O.N.) de 95 o mas



Esta necesidad es recordada por un punto verde en la parte inferior de la tapa del depósito y por la etiqueta “E10” en el depósito de gasolina.



- ▶ Levantar la tapa parapolvero.
- ▶ Introducir la llave y girarla en sentido horario.





► Levantar la tapa y efectuar el abastecimiento de carburante.



**PELIGRO:** Llenando excesivamente el depósito puede provocar derrame del carburante debido a la expansión del calor provocada por el calor del motor o a la exposición de la motocicleta a la luz del sol. Eventual derrame de carburante puede provocar incendios. El nivel del carburante en el depósito no debe superar nunca la base de la boca de llenado.

► Después del abastecimiento presionar el tapón hacia abajo girando contemporáneamente la llave en sentido horario para facilitar el cierre. Soltar la llave y extraírla.



**Prudencia - Precaución:** secar enseguida con un trapo limpio eventual carburante derramado, puesto que podría dañar la superficie pintada o de plástico.



**PELIGRO:** Verificar que la tapa del depósito del carburante esté cerrada correctamente antes de utilizar el vehículo.

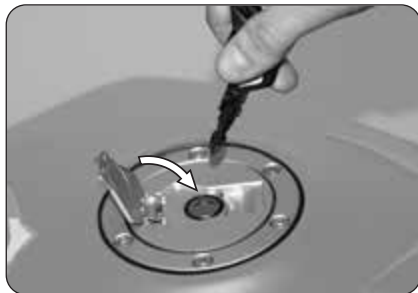



#### 4.6. Extracción del asiento pasajero

- ▶ Introducir la llave.
- ▶ Presione ligeramente el sillín y simultáneamente girar la llave en sentido contrario a las agujas del reloj. Levantar el sillín y quitarlo, como se muestra en la figura.

Para montar nuevamente la pieza, seguir las siguientes indicaciones:

- Girar la llave en la cerradura;
- Montar y enganchar el sillín;
- Presionar el sillín;
- Soltar la llave;
- Presionar nuevamente sobre el sillín cerciorándose que el mismo se encuentre muy bien enganchado a la estructura.



**CUIDADO:** Después de haber quitado y recolocado el sillín, y de todas maneras antes de utilizar la motocicleta, cerciorarse que el mismo haya sido colocado correctamente y que se encuentre bien sujeto a la estructura principal del vehículo.

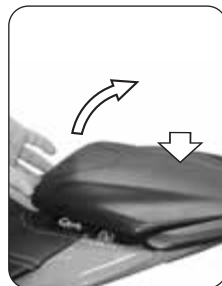
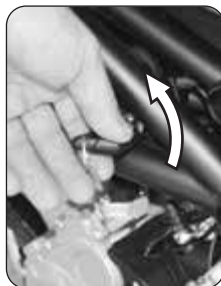



#### 4.7. Extracción del asiento del piloto

- ▶ Quitar el sillín pasajero como se indica en el párrafo §4.6.
- ▶ Quitar los dos tornillos de fijación traseros y los dos espaciadores con un destornillador hexagonal de 4 mm. Levantar el asiento y quitarlo, como se muestra en la figura.

Para montar nuevamente la pieza, seguir las siguientes indicaciones:

- Montar el asiento;
- Montar los dos tornillos de fijación traseros y los dos espaciadores;
- Montar el sillín pasajero como se indica en el párrafo §4.6.



**CUIDADO:** Después de haber quitado y recolocado el sillín, y de todas maneras antes de utilizar la motocicleta, cerciorarse que el mismo haya sido colocado correctamente y que se encuentre bien sujeto a la estructura principal del vehículo.





#### 4.8. Estacionamiento de la motocicleta

##### ❑ Estacionamiento con caballete lateral



**ATENCIÓN:** Aparcar la motocicleta en condiciones de seguridad y en un terreno estable. En las pendientes estacionar la moto con la rueda delantera hacia la subida y con la primera velocidad engranada; recordarse de retornar el cambio en neutro antes de poner en marcha el vehículo. No dejar el vehículo sin custodia con la llave de encendido introducida en el cuadro.



**ATENCIÓN:** Cuando el vehículo esté parado sobre el caballete lateral, es peligroso sentarse sobre él cargando todo el peso sobre el único apoyo de estacionamiento. Antes de ponerse en marcha verificar el buen funcionamiento del interruptor de seguridad cerciorándose que la luz testigo del caballete lateral ubicada en el tablero se apague; de todas maneras verificar que el caballete lateral haya retornado. Si se nota una imperfección, hacer controlar la instalación por un concesionario MV Agusta antes de utilizar el vehículo.

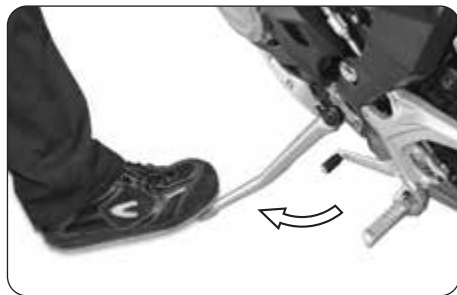

- Bajar el caballete con el pie hasta el tope e inclinar lentamente la motocicleta para colocar el pie de apoyo a contacto con el suelo.



#### □ Estacionamiento con caballete trasero

Introducir el perno del caballete en el orificio del eje de la rueda trasera en el lado izquierdo de la moto; apoyar el caballete en el suelo y empujándolo, levantar el vehículo hasta que el vehículo esté estable.



#### **CUIDADO**

Esta operación se debe realizar por dos personas.





### 5.1. Lista regulaciones

La motocicleta posee una amplia posibilidad de regulaciones que pueden mejorar la ergonomía, la estabilidad y la seguridad.

Sin embargo algunas de estas regulaciones pueden ser realizadas exclusivamente por los Centros de Asistencia MV Agusta, dado que una regulación errónea de ciertos componentes sumamente importantes puede provocar una situación de peligro.



#### **ATENCIÓN**

**Las regulaciones se deben realizar con el vehículo parado.**



(F) Regulación espejo retrovisor (§5.6.)

(A) Regulación palanca  
freno delantero (§5.3.)

(H) Regulación suspensión delantera  
(§5.7.)

(M) Orientación faro (§5.9.)

(D) Regulación palanca  
freno trasero (§5.2.)

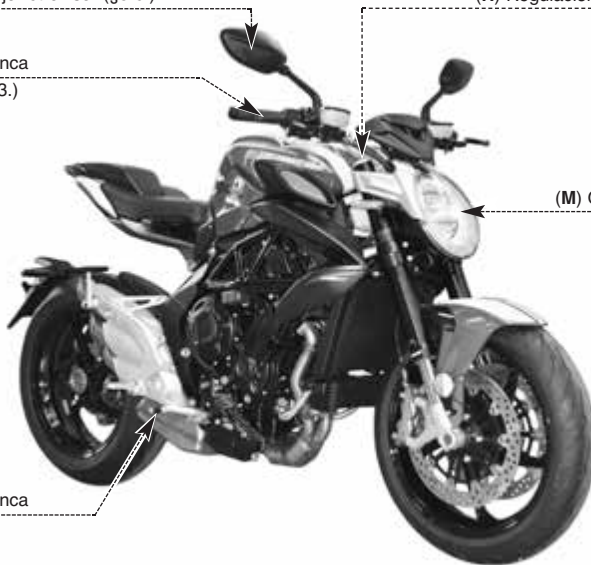





(F) Regulación espejo retrovisor (§5.6.)

(E) Regulación amortiguador de dirección  
(Brutale RR) (§5.5.)

(B) Regulación  
palanca embrague (§5.4.)

(L) Regulación suspensión trasera (§5.8.)

(C) Regulación  
palanca cambio (§5.2.)

(G) Regulación cadena (§5.2.)

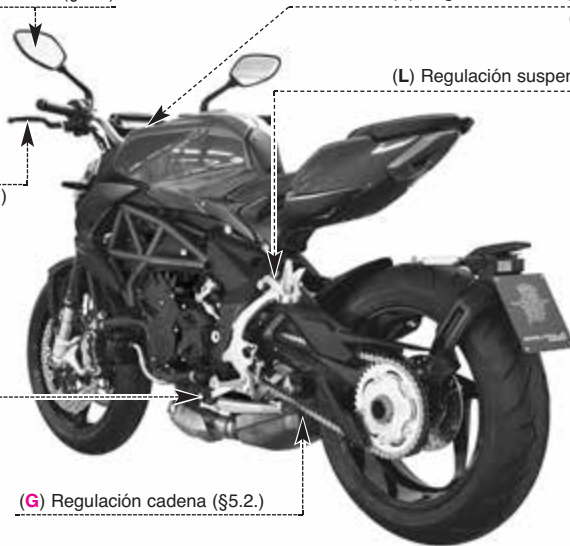



## 5.2. Tabla de las regulaciones

	<b>A - Regulación palanca freno delantero:</b> para optimizar el funcionamiento según las exigencias del motociclista (§5.3).		<b>G - Regulación cadena:</b> para la eficacia y la seguridad de la transmisión.
	<b>B - Regulación palanca embrague:</b> para optimizar el funcionamiento según las exigencias del motociclista (§5.4).		<b>H - Regulación suspensión delantera:</b> para adaptar su respuesta a las preferencias del motociclista se pueden regular: <ul style="list-style-type: none"><li>- precarga muelle (§5.7.1.)</li><li>- dispositivo hidráulico de frenado en extensión (§5.7.2.)</li><li>- dispositivo hidráulico de frenado en compresión (§5.7.3.)</li></ul>
	<b>C - Regulación palanca cambio:</b> para optimizar el movimiento del mando en función de las exigencias del motociclista.		<b>L - Regulación suspensión trasera:</b> para adaptar su respuesta a las preferencias del motociclista se pueden regular: <ul style="list-style-type: none"><li>- altura rectificado</li><li>- precarga muelle</li><li>- dispositivo hidráulico de frenado en extensión (§5.8.1.)</li><li>- dispositivo hidráulico de frenado en compresión (§5.8.2.)</li></ul>
	<b>D - Regulación palanca freno trasero:</b> para optimizar el movimiento de los mandos en función de las exigencias del motociclista.		<b>M - Orientación faro:</b> para optimizar la profundidad del haz luminoso en función del equilibrado (§5.9).
	<b>E - Regulación amortiguador de dirección (Brutale RR):</b> para adaptar la dureza del manillar a las preferencias del motociclista (§5.5).		
	<b>F - Regulación espejos retrovisores:</b> para optimizar la orientación (§5.6).		
	<b>¡ ATENCION: No intervenir en el tornillo de fijación del espejo retrovisor al manillar. En caso de necesidad, dirigirse a un concesionario MV Agusta.</b>		



### 5.3. Regulación palanca del freno delantero

Girar el registro de regulación de la palanca para modificar la posición.

En sentido horario: la palanca se acerca al mando. En sentido anti-horario: la palanca se aleja del mando.



### 5.4. Regulación palanca embrague

Girar el registro de regulación de la palanca para modificar la posición.

En sentido horario: la palanca se acerca al mando. En sentido anti-horario: la palanca se aleja del mando.

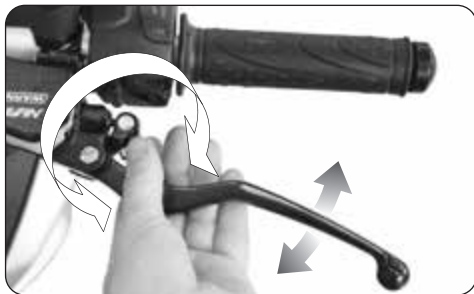



### 5.5. Regulación del amortiguador de dirección (Brutale RR)

La regulación estándar se obtiene girando el botón en sentido contrario a las agujas del reloj hasta el final de la carrera; en ésta posición el amortiguador da la menor resistencia a la acción de la dirección. Sobre la base de las propias necesidades de conducción es posible aumentar de manera gradual la acción de frenado del amortiguador de la dirección girando el botón en el sentido de las agujas del reloj.

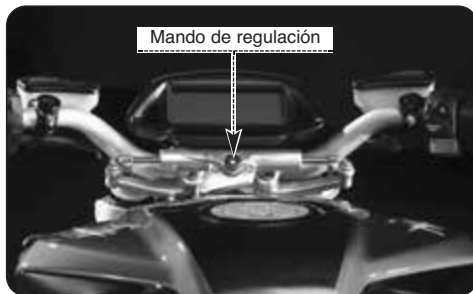



### 5.6. Regulación de los espejos retrovisores

Gire el cuerpo del espejo retrovisor para regular la posición en las cuatro direcciones.

Efectuar el ajuste en ambos espejos retrovisores. Para realizar un óptimo ajuste, aconsejamos realizarlo subidos en el vehículo.



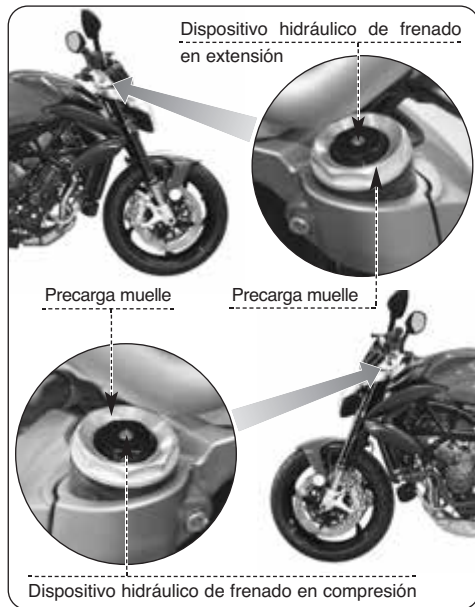

## 5.7. Regulación de la suspensión delantera

**NOTA:** La regulación de las suspensiones se debe realizar preferiblemente con el depósito del combustible lleno.

### 5.7.1. Precarga muelle (suspensión delantera)

La regulación se debe efectuar partiendo de la posición standard. Para encontrar tal posición es necesario girar en sentido contrario a las agujas del reloj hasta el tope, después en sentido horario hasta la posición standard (véase tabla adjunta). Gire en sentido horario para aumentar la precarga muelle, o bien gire en sentido contrario a las agujas del reloj para disminuirla.





### 5.7.2. Dispositivo hidráulico de frenado en extensión (suspensión delantera)

La regulación se debe efectuar partiendo de la posición standard. Para encontrar tal posición es necesario girar en sentido horario hasta el tope, después en sentido contrario a las agujas del reloj hasta la posición standard (véase tabla). Gire en sentido horario para aumentar la acción de frenado, o bien gire en sentido contrario a las agujas del reloj para disminuirla.

### 5.7.3. Dispositivo hidráulico de frenado en compresión (suspensión delantera)

La regulación se debe efectuar partiendo de la posición standard. Para encontrar tal posición es necesario girar en sentido horario hasta el tope, después en sentido contrario a las agujas del reloj hasta la posición standard (véase tabla). Gire en sentido horario para aumentar la acción de frenado, o bien gire en sentido contrario a las agujas del reloj para disminuirla.





### 5.8. Regulación de la suspensión trasera



#### PELIGRO

El amortiguador contiene gas de alta presión. No intentar de ninguna manera efectuar el desmontaje.

**NOTA:** La regulación de las suspensiones se debe realizar preferiblemente con el depósito del combustible lleno.

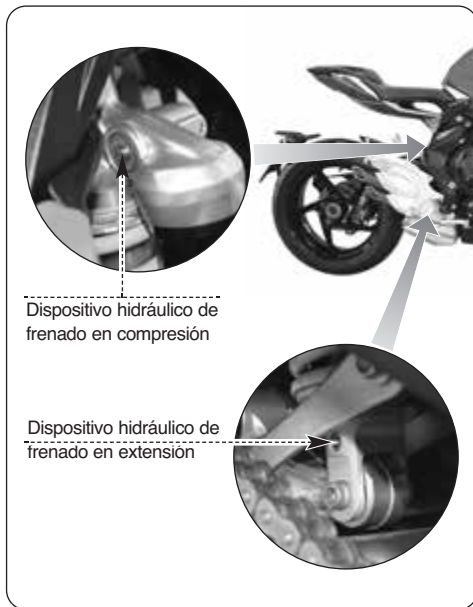

Dispositivo hidráulico de frenado en compresión

Dispositivo hidráulico de frenado en extensión





### 5.8.1. Dispositivo hidráulico de frenado en extensión (suspensión trasera)

La regulación se debe efectuar partiendo de la posición standard. Para encontrar tal posición es necesario girar en sentido horario hasta el tope, después en sentido contrario a las agujas del reloj hasta la posición standard (véase tabla). Gire en sentido horario para aumentar la acción de frenado, o bien gire en sentido contrario a las agujas del reloj para disminuirla.

### 5.8.2. Dispositivo hidráulico de frenado en compresión (suspensión trasera)

La regulación se debe efectuar partiendo de la posición standard. Para encontrar tal posición es necesario girar en sentido horario hasta el tope, después en sentido contrario a las agujas del reloj hasta la posición standard (véase tabla). Gire en sentido horario para aumentar la acción de frenado, o bien gire en sentido contrario a las agujas del reloj para disminuirla.





### 5.9. Ajuste proyector delantero

Colocar el vehículo a 10 metros de distancia de una pared vertical.

Asegurarse que el piso esté plano y que el eje óptico del proyector se encuentre perpendicular a la pared. El vehículo debe estar en posición vertical. Medir la altura del centro del proyector desde el suelo y marcar a esa altura la pared con una cruz.

Prendiendo la luz de cruce, el límite de demarcación entre la zona oscura y la zona iluminada debe resultar a una altura no superior a  $9/10$  de la altura desde el suelo del centro del proyector.

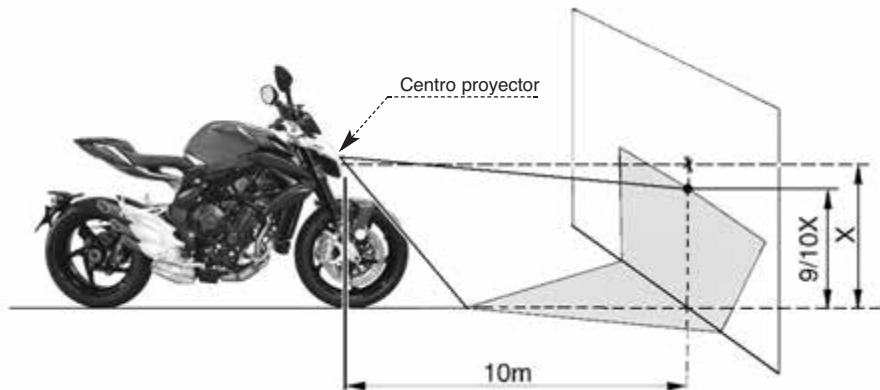



La regulación del faro delantero se puede realizar actuando en el tornillo que se muestra al lado. En sentido de las agujas del reloj: el faro se inclina hacia abajo. En sentido contrario a las agujas del reloj: el faro se inclina hacia arriba.

La inclinación se puede variar de  $\pm 4^\circ$  respecto a la posición estándar.

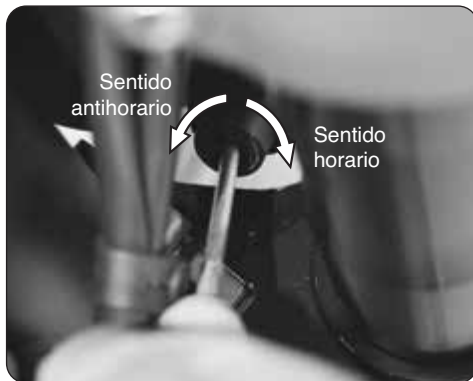



## Nota informativa

MV Agusta Motor S.p.A. está comprometida en una política de continuo mejoramiento de sus productos; por este motivo es posible encontrar ligeras diferencias entre el contenido de éste documento y el vehículo adquirido por Ustedes. Los modelos MV Agusta son exportados en muchos Países, en los cuales el Código del Tránsito y a los procedimientos de homologación son distintos a los nuestros.

Confiamos en su comprensión. MV Agusta Motor S.p.A. considera por lo tanto necesario reservarse el derecho de aportar modificaciones a sus productos y a la documentación técnica en cualquier momento y sin ningún aviso previo.

Sugerimos para visitar a menudo el sitio Internet **www.mvagusta.it** para obtener informaciones y actualizaciones sobre los productos MV Agusta y la documentación relacionada.



## Respetemos y defendamos el medioambiente

Todo lo que hacemos tiene repercusiones para todo el planeta y en sus recursos.

MV Agusta, a tutela de los intereses de la comunidad, sensibiliza los Clientes y los operadores de la asistencia técnica a adoptar una utilización del vehículo y de eliminación de sus partes, respetando plenamente las normativas vigentes en términos de contaminación del medio ambiente, eliminación y reciclaje de los desechos.

© 2017

Está prohibida la reproducción aunque sea parcial de éste documento sin el consentimiento escrito por MV Agusta Motor S.p.A.

Part. n° 8000C5107

Edición n° 1 - Noviembre 2017



A series of horizontal dotted lines for taking notes, spanning the width of the page.

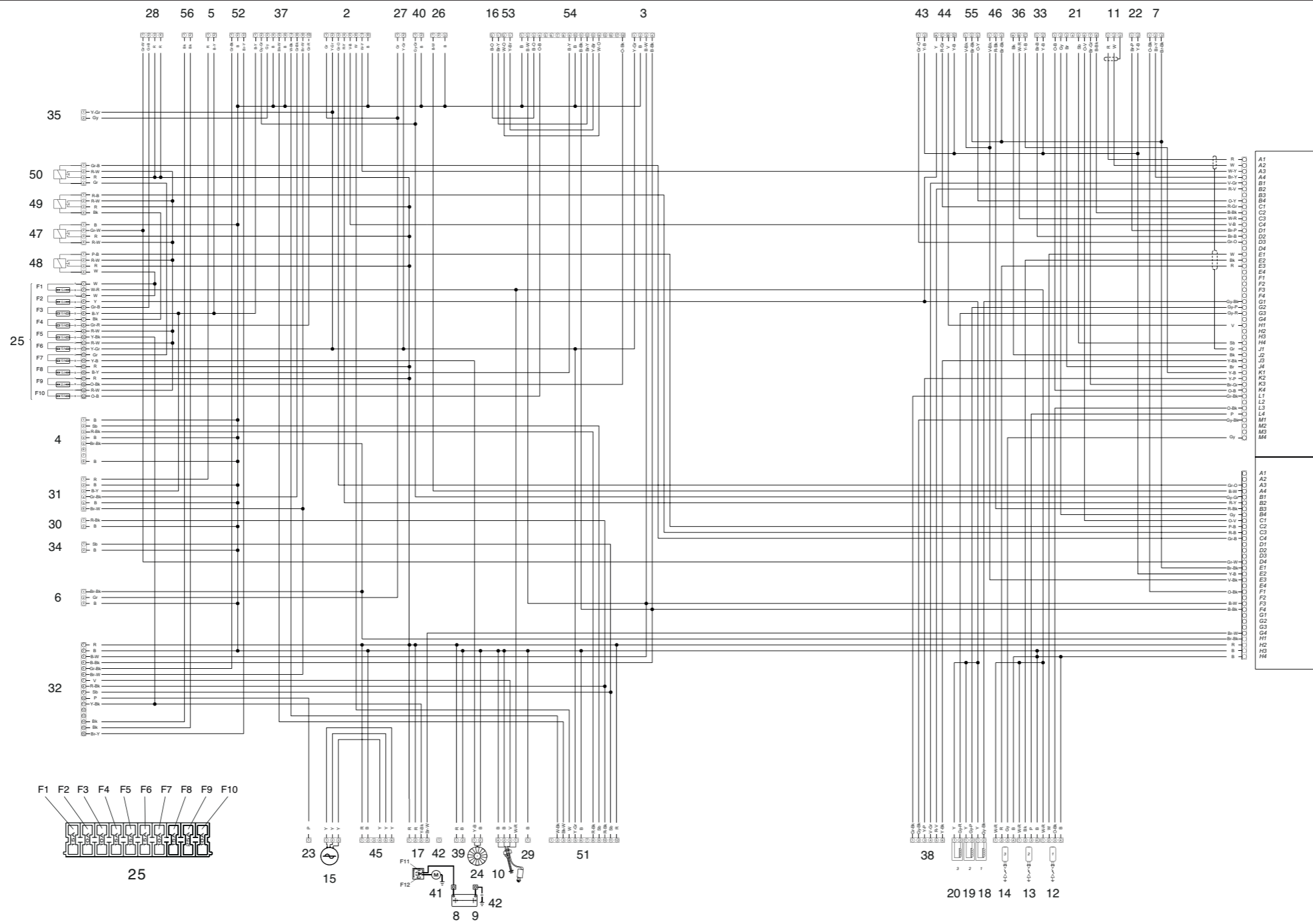

Legenda componenti	
Rif.	Descrizione
1	Centralina
2	Commutatore destro
3	Diagnostica
4	Sezionamento luci posteriori
5	DRL ( <i>Brutale 800 / Esclusi USA</i> )
6	Fanale posteriore - Stop
7	Sensore marce
8-9	Batteria
10	Pompa - Sonda benzina
11	Sensore giri motore
12	Bobina
13	Bobina
14	Bobina
15	Alternatore
16	Sensore velocità anteriore
17	Teleruttore
18-19-20	Iniettori inferiori
21	Potenzimetro farfalla

Legenda componenti	
Rif.	Descrizione
22	Sensore temperatura acqua per centralina
23	Interruttore olio
24	Elettroventola
25	Fusibili
26	Interruttore stampella laterale
27	Interruttore stop posteriore
28	Interruttore chiave
29	Massa telaio
30	Indicatore anteriore destro
31	Fanale anteriore
32	Cruscotto
33	Sensore temperatura aria
34	Indicatore anteriore sinistro
35	Avvisatore acustico
36	Sensore pressione aria
37	Commutatore sinistro
38	Modulo "Drive By Wire"
39	Ricarica batteria

Legenda componenti	
Rif.	Descrizione
40	Interruttore frizione
41	Motorino avviamento
42	Massa motore
43	Sensore temperatura acqua per ventola
44	Sonda lambda
45	Regolatore di tensione
46	Sensore di caduta
47	Relé generale
48	Relé iniezione
49	Relé luci
50	Relé elettroventola
51	Intermittenza
52	Pulsante SET/OK
53	Sensore velocità posteriore
54	Modulo ABS
55	Sensore EAS
56	Antenna Immobilizer

Legenda colori cavi	
Lettera/e	Colore
R	Rosso
Y	Giallo
B	Blu
G	Verde
W	Bianco
Bk	Nero
P	Rosa
V	Viola
Sb	Azzurro
Gr	Grigio
O	Arancio
Br	Marrone

Nei colori combinati è indicato il colore di fondo e la marcatura. Es.: Br/Bk.

Legenda fusibili		
Rif.	Amperaggio (A)	Utilizzo
F1	15	Pompa carburante - Bobine
F2	10	Sonda lambda - Iniettori
F3	10	Luci di posizione - Luce targa
F4	15	Luce abbagliante / anabbagliante
F5	15	Relé avviamento - Sensore velocità anteriore - Sensore velocità posteriore - Cruscotto - Sensore di assetto
F6	15	Intermittenza - Avvisatore acustico Luce stop - Diagnostica
F7	10	Ventola di raffreddamento
F8	15	Modulo ABS
F9	25	Modulo ABS
F10	10	Modulo ABS
F11	30	Ricarica batteria
F12	30	Scorta per ricarica batteria

Parts list	
Ref.	Description
1	Power unit
2	RH switch
3	Diagnostics
4	Rear lights sectioning
5	DRL ( <i>Brutale 800 / USA excluded</i> )
6	Brake light
7	Gear sensor
8-9	Battery
10	Pump - Low fuel probe
11	Engine rpm sensor
12	Coil
13	Coil
14	Coil
15	Alternator

Parts list	
Ref.	Description
16	Front speed sensor
17	Solenoid starter
18-19-20	Lower injectors
21	Throttle potentiometer
22	Water temperature sensor for power unit
23	Oil switch
24	Heater fan
25	Fuses
26	Side stand switch
27	Rear brake switch
28	Key switch
29	Frame ground
30	Front turn indicator, right hand
31	Front light

Parts list	
Ref.	Description
32	Display
33	Air temperature sensor
34	Front turn indicator, left hand
35	Horn
36	Air pressure sensor
37	LH switch
38	"Drive By Wire" unit
39	Battery recharge
40	Clutch switch
41	Starter
42	Engine ground
43	Water temperature sensor for fan
44	Lambda sensor
45	Voltage regulator

Parts list	
Ref.	Description
46	Tilt sensor
47	Main relay
48	Injection relay
49	High/Low beam relay
50	Relay for electric fan
51	Intermittence
52	SET/OK button
53	Rear speed sensor
54	ABS unit
55	EAS sensor
56	Immobilizer antenna

Wire colors list	
Letter(s)	Color
R	Red
Y	Yellow
B	Blue
G	Green
W	White
Bk	Black
P	Pink
V	Violet
Sb	Sky blue
Gr	Grey
O	Orange
Br	Brown

In combined colors, background and marking colors have been pointed out. E.g. : Br/Bk.

Fuses list		
Ref.	Amperage (A)	Application
F1	15	Fuel pump - Coils
F2	10	Lambda sensor - Injectors
F3	10	Position lights-License plate light
F4	15	High beam - Low beam
F5	15	Solenoid starter - Front/Rear speed sensor - Dashboard - Lean angle sensor
F6	15	Intermittence - Horn - Stop light - Diagnostics
F7	10	Electric fan
F8	15	ABS unit
F9	25	ABS unit
F10	10	ABS unit
F11	30	Battery recharge
F12	30	Battery recharge supply

Légende des composants	
Réf.	Description
1	Boîtier d'allumage
2	Commutateur droit
3	Diagnostics
4	Sectionnement des feux arrières
5	DRL ( <i>Brutale 800 / Sauf les USA</i> )
6	Feu arrière "Stop"
7	Capteur de boîte de vitesse
8-9	Batterie
10	Pompe - Sonde essence
11	Capteur compte tours
12	Bobine
13	Bobine
14	Bobine
15	Alternateur

Légende des composants	
Réf.	Description
16	Capteur de vitesse avant
17	Télérupteur
18-19-20	Injecteurs inférieurs
21	Centrale clignotante
22	Capteur de température d'eau pour boîtier
23	Manocontact d'huile
24	Electroventilateur
25	Fusibles
26	Contacteur de béquille latérale
27	Contacteur de stop arrière
28	Contacteur principal à clé
29	Masse châssis
30	Clignotant avant D.
31	Feu avant

Légende des composants	
Réf.	Description
32	Tableau de bord
33	Capteur pour température air
34	Clignotant avant G.
35	Avertisseur sonore
36	Capteur pour pression air
37	Commutateur gauche
38	Commande "Drive By Wire"
39	Charge batterie
40	Contacteur embrayage
41	Démarrateur électrique
42	Masse moteur
43	Capteur de température d'eau pour ventilateur
44	Sonde Lambda

Légende des composants	
Réf.	Description
45	Régulateur de tension
46	Capteur de chute
47	Relais general
48	Relais injection
49	Relais feux
50	Relais pour electro-ventilateur
51	Centrale clignotante
52	Bouton SET/OK
53	Capteur de vitesse arrière
54	Module ABS
55	Capteur EAS
56	Antenne Immobilizer

Légende couleur des câbles	
Lettre(s)	Couleur
R	Rouge
Y	Jaune
B	Bleu
G	Vert
W	Blanc
Bk	Noir
P	Rose
V	Violet
Sb	Bleu ciel
Gr	Gris
O	Orange
Br	Marron

Pour les couleurs combinés, la couleur de fond et le marquage sont indiqués. Par ex. Br/Bk.

Légende des fusibles		
Réf.	Ampérage (A)	Emploi
F1	15	Pompe à carburant - Bobines
F2	10	Sonde Lambda - Injecteurs
F3	10	Feux de position - Feu plaque
F4	15	Feu de croisement-Feu de route
F5	15	Télérupteur du démarreur - Capteur de vitesse avant/arrière - Tableau de bord - Capteur d'inclinaison
F6	15	Centrale clignotante-Avertisseur-Feu stop - Diagnostics
F7	10	Electroventilateur
F8	15	Module ABS
F9	25	Module ABS
F10	10	Module ABS
F11	30	Charge batterie
F12	30	Réserve recharge batterie

Zeichenerklärung Bauteile	
Rif.	Beschreibung
1	Zündbox
2	Rechter Wechselschalter
3	Diagnostik
4	Schnitte der Rückleuchten
5	DRL ( <i>Brutale 800 / Ausgenommen USA</i> )
6	Rücklicht - Bremslicht
7	Getriebe-Sensor
8-9	Batterie
10	Pumpe - Benzinstandgeber
11	Sensor Motordrehzahl
12	Spule
13	Spule
14	Spule
15	Lichtmaschine

Zeichenerklärung Bauteile	
Rif.	Beschreibung
16	Vorderer Geschwindigkeitssensor
17	Fernrelais
18-19-20	Untere Einspritzdüsen
21	Potentiometer Drosselventil
22	Wassertemperatur-Sensor für Kontrollbox
23	Öldruckschalter
24	Gebläse
25	Sicherungen
26	Schalter Seitenständer
27	Hinterer Bremslichtschalter
28	Zündschloß
29	Masse Rahmen
30	Vorderer Blinker, rechts
31	Vorderer Scheinwerfer

Zeichenerklärung Bauteile	
Rif.	Beschreibung
32	Armaturenbrett
33	Sensor für Temperatur von Luft
34	Vorderer Blinker, links
35	Hupe
36	Drucksensor von Luft
37	Linker Wechselschalter
38	Antrieb "Drive By Wire"
39	Batterieladung
40	Kupplungsschalter
41	Anlassermotor
42	Masse Motor
43	Wassertemperatur-Sensor für Gebläse
44	Lambdasonde
45	Spannungs-Regler

Zeichenerklärung Bauteile	
Rif.	Beschreibung
46	Neigung-Sensor
47	Hauptrelais
48	Einspritzrelais
49	Lichtrelais
50	Relais für Gebläse
51	Blinkgeber
52	Taste SET/OK
53	Hinterer Geschwindigkeitssensor
54	ABS-Einheit
55	EAS-Sensor
56	Immobilizer-Antenne

Zeichenerklärung Kabelfarben	
Buchstabe(n)	Farbe
R	Rot
Y	Gelb
B	Blau
G	Grün
W	Weiß
Bk	Schwarz
P	Rose
V	Violett
Sb	Hellblau
Gr	Grau
O	Orange
Br	Braun

Bei Farbkombinationen wird die Grundfarbe und die Markierung angegeben. Z. B. Br/Bk.

Zeichenerklärung Sicherungen		
Nr.	Ampereleistung (A)	Einsatz
F1	15	Benzinpumpe - Spulen
F2	10	Lambda-sonde - Einspritzventil
F3	10	Standlicht-Nummernschildlicht
F4	15	Fernlicht - Abblendlicht
F5	15	Anlasser Fernrelais- Geschwindigkeitssensor vorn/hinten - Armaturenbrett - Neigung-Sensor
F6	15	Blinkgeber - Hupe - Bremslicht - Diagnostik
F7	10	Gebläse
F8	15	Module ABS
F9	25	Module ABS
F10	10	Module ABS
F11	30	Batterieladung
F12	30	Ersatz für Batterieladung

Leyenda Componentes	
Ref.	Descripción
1	Central
2	Conmutador derecho
3	Diagnóstico
4	Seccionamiento de las luces traseras
5	DRL ( <i>Brutale 800 / Excluidos los USA</i> )
6	Faro trasero - Stop
7	Sensor del cambio
8-9	Batería
10	Bomba - Sonda gasolina
11	Sensor revoluciones motor
12	Bobina
13	Bobina
14	Bobina
15	Alternador

Leyenda Componentes	
Ref.	Descripción
16	Sensor velocidad delantero
17	Teleruptor
18-19-20	Inyectores inferiores
21	Potenciómetro mariposa
22	Sensor temperatura agua para central
23	Interruptor aceite
24	Electroventilador
25	Fusibles
26	Interruptor pata lateral
27	Interruptor stop trasero
28	Interruptor llave
29	Masa bastidor
30	Indicador trasero derecho
31	Faro delantero

Leyenda Componentes	
Ref.	Descripción
32	Cuadro mandos
33	Sensor temperatura aire
34	Indicador trasero izquierdo
35	Claxon
36	Sensor presión aire
37	Conmutador izquierdo
38	Sistema "Drive By Wire"
39	Recarga batería
40	Interruptor embrague
41	Motor de arranque
42	Masa motor
43	Sensor temperatura agua para ventilador
44	Sonda Lambda
45	Regolador de tensión

Leyenda Componentes	
Ref.	Descripción
46	Sensor de caída
47	Relé general
48	Relé inyección
49	Relé luces
50	Relé por electroventilador
51	Intermitencia
52	Pulsador SET/OK
53	Sensor velocidad trasero
54	Módulo ABS
55	Sensor EAS
56	Antena Immobilizer

Leyenda colores cables	
Letra/s	Color
R	Rojo
Y	Amarillo
B	Azul marino
G	Verde
W	Blanco
Bk	Negro
P	Rosa
V	Violeta
Sb	Azul
Gr	Gris
O	Naranja
Br	Marrón

En los colores combinados se indica el color de fondo y la marcación Ej. Br/Bk.

Leyenda fusibles		
Ref.	Amperaje (A)	Utilización
F1	15	Bomba carburante - Bobinas
F2	10	Sonda Lambda - Inyectores
F3	10	Luz de posición - Luz matrícula
F4	15	Luz de carretera - Luz de cruce
F5	15	Teleruptor de arranque - Sensor velocidad delantero/trasero - Cuadro mandos - Sensor de inclinación
F6	15	Intermitencia-Claxon-Luz stop - Diagnóstico
F7	10	Electroventilador
F8	15	Módulo ABS
F9	25	Módulo ABS
F10	10	Módulo ABS
F11	30	Recarga batería
F12	30	Repuesto recarga batería



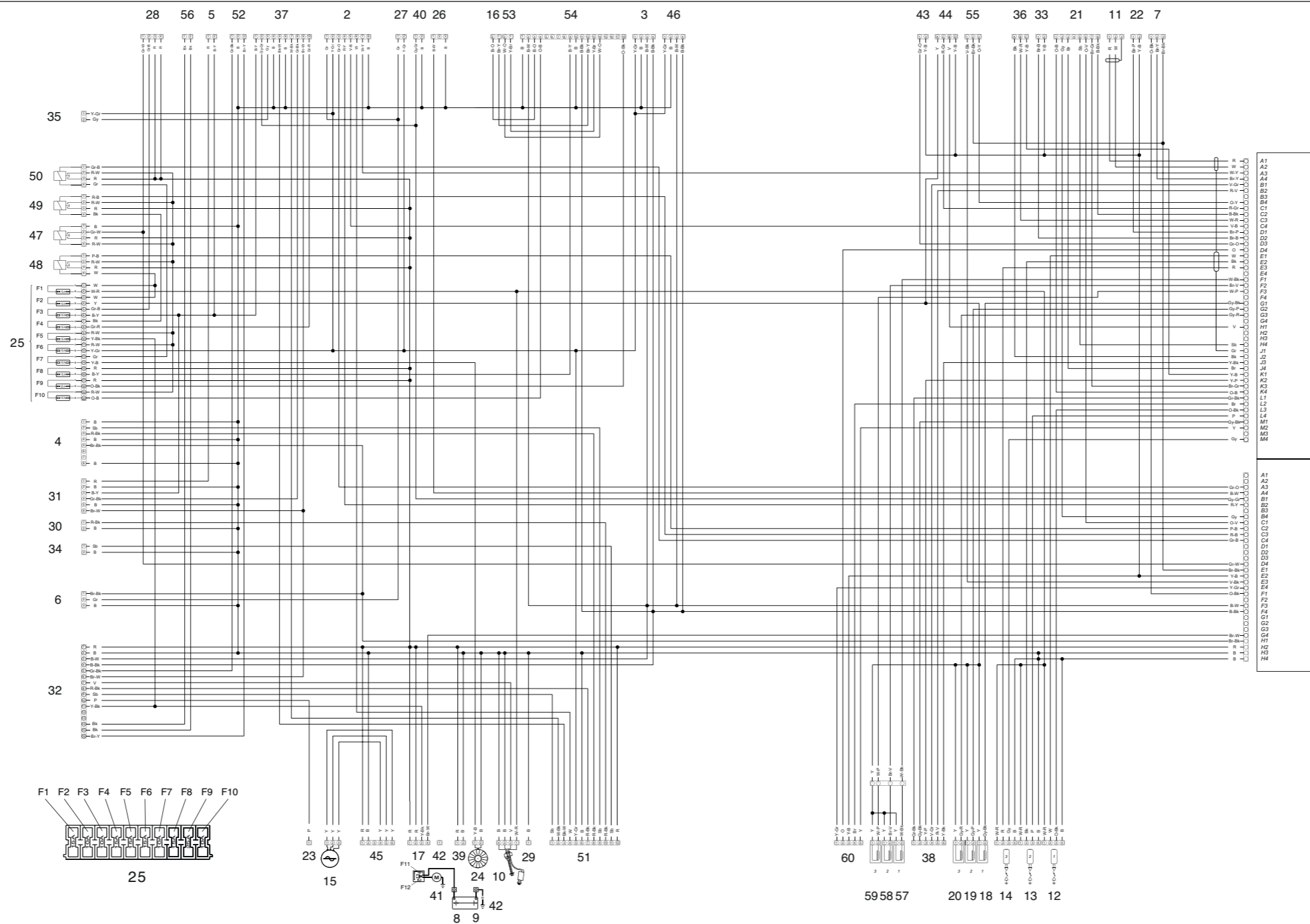

Legenda componenti	
Rif.	Descrizione
1	Centralina
2	Commutatore destro
3	Diagnostica
4	Sezionamento luci posteriori
5	DRL (esclusi USA)
6	Fanale posteriore - Stop
7	Sensore marce
8-9	Batteria
10	Pompa - Sonda benzina
11	Sensore giri motore
12-13-14	Bobine
15	Alternatore
16	Sensore velocità anteriore
17	Teleruttore
18-19-20	Iniettori inferiori
21	Potenzimetro farfalla
22	Sensore temperatura acqua per centralina
23	Interruttore olio

Legenda componenti	
Rif.	Descrizione
24	Elettroventola
25	Fusibili
26	Interruttore stampella laterale
27	Interruttore stop posteriore
28	Interruttore chiave
29	Massa telaio
30	Indicatore anteriore destro
31	Fanale anteriore
32	Cruscotto
33	Sensore temperatura aria
34	Indicatore anteriore sinistro
35	Avvisatore acustico
36	Sensore pressione aria
37	Commutatore sinistro
38	Modulo "Drive By Wire"
39	Ricarica batteria
40	Interruttore frizione
41	Motorino avviamento

Legenda componenti	
Rif.	Descrizione
42	Massa motore
43	Sensore temperatura acqua per ventola
44	Sonda lambda
45	Regolatore di tensione
46	Sensore di assetto
47	Relé generale
48	Relé iniezione
49	Relé luci
50	Relé elettroventola
51	Intermittenza
52	Pulsante SET/OK
53	Sensore velocità posteriore
54	Modulo ABS
55	Sensore EAS
56	Antenna Immobilizer
57-58-59	Iniettori superiori
60	Attuatore valvola di scarico

Legenda colori cavi	
Lettera/e	Colore
R	Rosso
Y	Giallo
B	Blu
G	Verde
W	Bianco
Bk	Nero
P	Rosa
V	Viola
Sb	Azzurro
Gr	Grigio
O	Arancio
Br	Marrone

Nei colori combinati è indicato il colore di fondo e la marcatura. Es.: Br/Bk.

Legenda fusibili		
Rif.	Amperaggio (A)	Utilizzo
F1	15	Pompa carburante - Bobine
F2	10	Sonda lambda - Iniettori
F3	10	Luci di posizione - Luce targa
F4	15	Luce abbagliante / anabbagliante
F5	15	Relé avviamento - Sensore velocità anteriore - Sensore velocità posteriore - Cruscotto - Sensore di assetto
F6	15	Intermittenza - Avvisatore acustico Luce stop - Diagnostica
F7	10	Ventola di raffreddamento
F8	15	Modulo ABS
F9	25	Modulo ABS
F10	10	Modulo ABS
F11	30	Ricarica batteria
F12	30	Scorta per ricarica batteria



Parts list	
Ref.	Description
1	Power unit
2	RH switch
3	Diagnostics
4	Rear lights sectioning
5	DRL (USA excluded)
6	Brake light
7	Gear sensor
8-9	Battery
10	Pump - Low fuel probe
11	Engine rpm sensor
12	Coil
13	Coil
14	Coil
15	Alternator

Parts list	
Ref.	Description
16	Front speed sensor
17	Solenoid starter
18-19-20	Lower injectors
21	Throttle potentiometer
22	Water temperature sensor for power unit
23	Oil switch
24	Heater fan
25	Fuses
26	Side stand switch
27	Rear brake switch
28	Key switch
29	Frame ground
30	Front turn indicator, right hand
31	Front light

Parts list	
Ref.	Description
32	Display
33	Air temperature sensor
34	Front turn indicator, left hand
35	Horn
36	Air pressure sensor
37	LH switch
38	"Drive By Wire" unit
39	Battery recharge
40	Clutch switch
41	Starter
42	Engine ground
43	Water temperature sensor for fan
44	Lambda sensor
45	Voltage regulator

Parts list	
Ref.	Description
46	Lean angle sensor
47	Main relay
48	Injection relay
49	High/Low beam relay
50	Relay for electric fan
51	Intermittence
52	SET/OK button
53	Rear speed sensor
54	ABS unit
55	EAS sensor
56	Immobilizer antenna
57-58-59	Upper injectors
60	Exhaust valve actuator

Wire colors list	
Letter(s)	Color
R	Red
Y	Yellow
B	Blue
G	Green
W	White
Bk	Black
P	Pink
V	Violet
Sb	Sky blue
Gr	Grey
O	Orange
Br	Brown

In combined colors, background and marking colors have been pointed out. E.g. : Br/Bk.

Fuses list		
Ref.	Amperage (A)	Application
F1	15	Fuel pump - Coils
F2	10	Lambda sensor - Injectors
F3	10	Position lights-License plate light
F4	15	High beam - Low beam
F5	15	Solenoid starter - Front/Rear speed sensor - Dashboard - Lean angle sensor
F6	15	Intermittence - Horn - Stop light - Diagnostics
F7	10	Electric fan
F8	15	ABS unit
F9	25	ABS unit
F10	10	ABS unit
F11	30	Battery recharge
F12	30	Battery recharge supply

Légende des composants	
Réf.	Description
1	Boîtier d'allumage
2	Commutateur droit
3	Diagnostics
4	Sectionnement des feux arrières
5	DRL (Sauf les USA)
6	Feu arrière "Stop"
7	Capteur de boîte de vitesse
8-9	Batterie
10	Pompe - Sonde essence
11	Capteur compte tours
12	Bobine
13	Bobine
14	Bobine
15	Alternateur

Légende des composants	
Réf.	Description
16	Capteur de vitesse avant
17	Télérupteur
18-19-20	Injecteurs inférieurs
21	Centrale clignotante
22	Capteur de température d'eau pour boîtier
23	Manocontact d'huile
24	Electroventilateur
25	Fusibles
26	Contacteur de béquille latérale
27	Contacteur de stop arrière
28	Contacteur principal à clé
29	Masse châssis
30	Clignotant avant D.
31	Feu avant

Légende des composants	
Réf.	Description
32	Tableau de bord
33	Capteur pour température air
34	Clignotant avant G.
35	Avertisseur sonore
36	Capteur pour pression air
37	Commutateur gauche
38	Commande "Drive By Wire"
39	Charge batterie
40	Contacteur embrayage
41	Démarrateur électrique
42	Masse moteur
43	Capteur de température d'eau pour ventilateur
44	Sonde Lambda

Légende des composants	
Réf.	Description
45	Régulateur de tension
46	Capteur d'inclinaison
47	Relais general
48	Relais injection
49	Relais feux
50	Relais pour electro-ventilateur
51	Centrale clignotante
52	Bouton SET/OK
53	Capteur de vitesse arrière
54	Module ABS
55	Capteur EAS
56	Antenne Immobilizer
57-58-59	Injecteurs supérieurs
60	Actuateur soupape d'échappement

Légende couleur des câbles	
Lettre(s)	Couleur
R	Rouge
Y	Jaune
B	Bleu
G	Vert
W	Blanc
Bk	Noir
P	Rose
V	Violet
Sb	Bleu ciel
Gr	Gris
O	Orange
Br	Marron

Pour les couleurs combinés, la couleur de fond et le marquage sont indiqués. Par ex. Br/Bk.

Légende des fusibles		
Réf.	Ampérage (A)	Emploi
F1	15	Pompe à carburant - Bobines
F2	10	Sonde Lambda - Injecteurs
F3	10	Feux de position - Feu plaque
F4	15	Feu de croisement-Feu de route
F5	15	Télérupteur du démarreur - Capteur de vitesse avant/arrière - Tableau de bord - Capteur d'inclinaison
F6	15	Centrale clignotante-Avertisseur-Feu stop - Diagnostics
F7	10	Electroventilateur
F8	15	Module ABS
F9	25	Module ABS
F10	10	Module ABS
F11	30	Charge batterie
F12	30	Réserve recharge batterie

Zeichenerklärung Bauteile	
Rif.	Beschreibung
1	Zündbox
2	Rechter Wechselschalter
3	Diagnostik
4	Schnitte der Rückleuchten
5	DRL (Ausgenommen USA)
6	Rücklicht - Bremslicht
7	Getriebe-Sensor
8-9	Batterie
10	Pumpe - Benzinstandgeber
11	Sensor Motordrehzahl
12	Spule
13	Spule
14	Spule
15	Lichtmaschine

Zeichenerklärung Bauteile	
Rif.	Beschreibung
16	Vorderer Geschwindigkeitssensor
17	Fernrelais
18-19-20	Untere Einspritzdüsen
21	Potentiometer Drosselventil
22	Wassertemperatur-Sensor für Kontrollbox
23	Öldruckschalter
24	Gebläse
25	Sicherungen
26	Schalter Seitenständer
27	Hinterer Bremslichtschalter
28	Zündschloß
29	Masse Rahmen
30	Vorderer Blinker, rechts
31	Vorderer Scheinwerfer

Zeichenerklärung Bauteile	
Rif.	Beschreibung
32	Armaturenbrett
33	Sensor für Temperatur von Luft
34	Vorderer Blinker, links
35	Hupe
36	Drucksensor von Luft
37	Linker Wechselschalter
38	Antrieb "Drive By Wire"
39	Batterieladung
40	Kupplungsschalter
41	Anlassermotor
42	Masse Motor
43	Wassertemperatur-Sensor für Gebläse
44	Lambdasonde
45	Spannungs-Regler

Zeichenerklärung Bauteile	
Rif.	Beschreibung
46	Neigung-Sensor
47	Hauptrelais
48	Einspritzrelais
49	Lichtrelais
50	Relais für Gebläse
51	Blinkgeber
52	Taste SET/OK
53	Hinterer Geschwindigkeitssensor
54	ABS-Einheit
55	EAS-Sensor
56	Immobilizer-Antenne
57-58-59	Obere Einspritzdüsen
60	Trieb Auslassventil

Zeichenerklärung Kabelfarben	
Buchstabe(n)	Farbe
R	Rot
Y	Gelb
B	Blau
G	Grün
W	Weiß
Bk	Schwarz
P	Rose
V	Violett
Sb	Hellblau
Gr	Grau
O	Orange
Br	Braun

Bei Farbkombinationen wird die Grundfarbe und die Markierung angegeben. Z. B. Br/Bk.

Zeichenerklärung Sicherungen		
Nr.	Ampere-leistung (A)	Einsatz
F1	15	Benzinpumpe - Spulen
F2	10	Lambda-sonde - Einspritzventil
F3	10	Standlicht-Nummernschildlicht
F4	15	Fernlicht - Abblendlicht
F5	15	Anlasser Fernrelais- Geschwindigkeitssensor vorn/hinten - Armaturenbrett - Neigung-Sensor
F6	15	Blinkgeber - Hupe - Bremslicht - Diagnostik
F7	10	Gebläse
F8	15	Module ABS
F9	25	Module ABS
F10	10	Module ABS
F11	30	Batterieladung
F12	30	Ersatz für Batterieladung

Leyenda Componentes	
Ref.	Descripción
1	Central
2	Conmutador derecho
3	Diagnóstico
4	Seccionamiento de las luces traseras
5	DRL (Excluidos los USA)
6	Faro trasero - Stop
7	Sensor del cambio
8-9	Batería
10	Bomba - Sonda gasolina
11	Sensor revoluciones motor
12	Bobina
13	Bobina
14	Bobina
15	Alternador

Leyenda Componentes	
Ref.	Descripción
16	Sensor velocidad delantero
17	Teleruptor
18-19-20	Inyectores inferiores
21	Potenciómetro mariposa
22	Sensor temperatura agua para central
23	Interruptor aceite
24	Electroventilador
25	Fusibles
26	Interruptor pata lateral
27	Interruptor stop trasero
28	Interruptor llave
29	Masa bastidor
30	Indicador trasero derecho
31	Faro delantero

Leyenda Componentes	
Ref.	Descripción
32	Cuadro mandos
33	Sensor temperatura aire
34	Indicador trasero izquierdo
35	Claxon
36	Sensor presión aire
37	Conmutador izquierdo
38	Sistema "Drive By Wire"
39	Recarga batería
40	Interruptor embrague
41	Motor de arranque
42	Masa motor
43	Sensor temperatura agua para ventilador
44	Sonda Lambda
45	Regolador de tensión

Leyenda Componentes	
Ref.	Descripción
46	Sensor de inclinación
47	Relé general
48	Relé inyección
49	Relé luces
50	Relé por electroventilador
51	Intermitencia
52	Pulsador SET/OK
53	Sensor velocidad trasero
54	Módulo ABS
55	Sensor EAS
56	Antena Immobilizer
57-58-59	Inyectores superiores
60	Accionador válvula de descarga

Leyenda colores cables	
Letra/s	Color
R	Rojo
Y	Amarillo
B	Azul marino
G	Verde
W	Blanco
Bk	Negro
P	Rosa
V	Violeta
Sb	Azul
Gr	Gris
O	Naranja
Br	Marrón

En los colores combinados se indica el color de fondo y la marcación Ej. Br/Bk.

Leyenda fusibles		
Ref.	Amperaje (A)	Utilización
F1	15	Bomba carburante - Bobinas
F2	10	Sonda Lambda - Inyectores
F3	10	Luz de posición - Luz matrícula
F4	15	Luz de carretera - Luz de cruce
F5	15	Teleruptor de arranque - Sensor velocidad delantero/trasero - Cuadro mandos - Sensor de inclinación
F6	15	Intermitencia-Claxon-Luz stop - Diagnóstico
F7	10	Electroventilador
F8	15	Módulo ABS
F9	25	Módulo ABS
F10	10	Módulo ABS
F11	30	Recarga batería
F12	30	Repuesto recarga batería

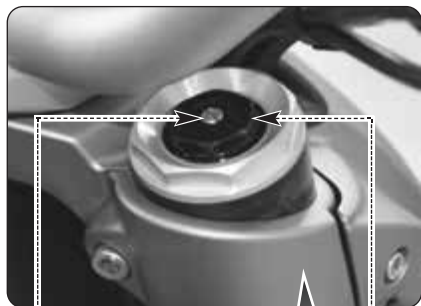

- Dispositivo idraulico di frenatura in estensione
- Rebound damping hydraulic device
- Dispositif hydraulique de freinage en détente
- Hydraulische Ausdehnungsbremse
- Dispositivo hidráulico de frenado en extensión

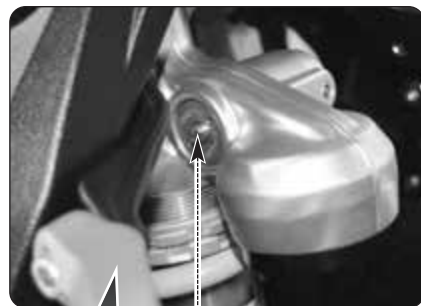

- Dispositivo idraulico di frenatura in compressione
- Compression damping hydraulic device
- Dispositif hydraulique de freinage en compression
- Hydraulische Kompressionsbremse
- Dispositivo hidráulico de frenado en compresión

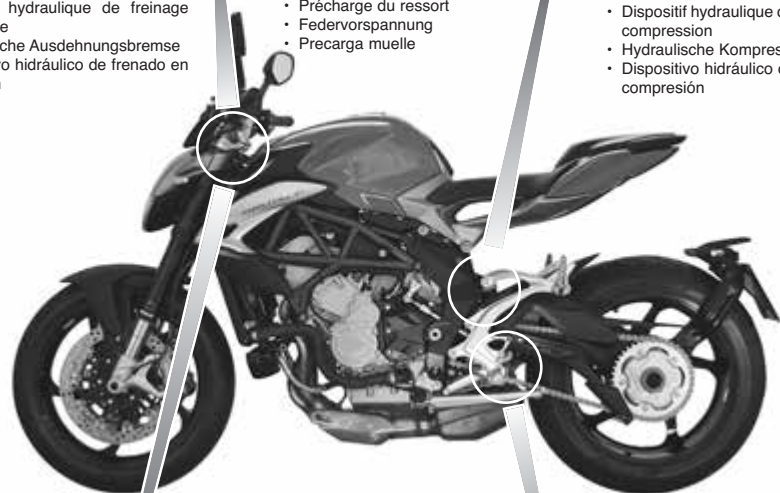

- Precarico molla
- Spring preload
- Précharge du ressort
- Federvorspannung
- Precarga muelle

- Dispositivo idraulico di frenatura in compressione
- Compression damping hydraulic device
- Dispositif hydraulique de freinage en compression
- Hydraulische Kompressionsbremse
- Dispositivo hidráulico de frenado en compresión

- Dispositivo idraulico di frenatura in estensione
- Rebound damping hydraulic device
- Dispositif hydraulique de freinage en détente
- Hydraulische Ausdehnungsbremse
- Dispositivo hidráulico de frenado en extensión

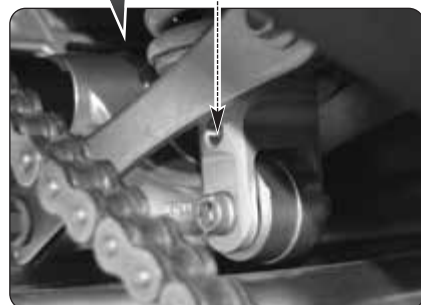
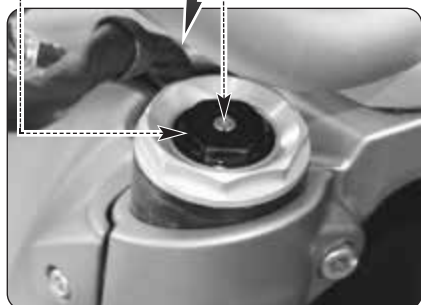

<b>BRUTALE 800</b>		<b>Brutale 800 MY16</b>	
		<b>Tipo di assetto - Type of geometry - Type d'assiette - Einstellungsart - Tipo de equilibrado</b>	
<b>Sospensione anteriore</b> <i>Front suspension Suspension avant Vordere Federung Suspensión delantera</i>	<b>Su strada - On road - Sur route - Auf Straße - En la carretera</b>		
	<b>Solo pilota - Rider only - Avec pilote - Nur Fahrer - Sólo piloto</b>		<b>Con passeggero - With passenger - Avec passager - Mit Beifahrer - Con pasajero</b>
	<b>6</b>	giri turns tours Drehzahlen revoluciones	<b>8</b>
<b>Precarico molla</b> <i>Spring preload Précharge du ressort Federvorspannung Precarga muelle</i>	<b>6</b>	giri turns tours Drehzahlen revoluciones	<b>8</b>
<b>Freno in estensione</b> <i>Rebound damping Frein en détente Ausdehnungsbremse Freno en extensión</i>	<b>2</b>	giri turns tours Drehzahlen revoluciones	<b>1</b>
<b>Freno in compressione</b> <i>Compression damping Frein en compression Kompressionsbremse Freno en compresión</i>	<b>2</b>	giri turns tours Drehzahlen revoluciones	<b>1</b>
<b>Sospensione posteriore</b> <i>Rear suspension Suspension arrière Hintere Federung Suspensión trasera</i>	<b>Su strada - On road - Sur route - Auf Straße - En la carretera</b>		
	<b>Solo pilota - Rider only - Avec pilote - Nur Fahrer - Sólo piloto</b>		<b>Con passeggero - With passenger - Avec passager - Mit Beifahrer - Con pasajero</b>
	<b>1,5</b>	giri turns tours Drehzahlen revoluciones	<b>1,5</b>
<b>Frenatura in estensione</b> <i>Rebound damping Freinage en détente Ausdehnungsbremse Frenado en extensión</i>	<b>1,5</b>	giri turns tours Drehzahlen revoluciones	<b>1,5</b>
<b>Frenatura in compressione</b> <i>Compression damping Freinage en compression Kompressionsbremse Frenado en compresión</i>	<b>3</b>	giri turns tours Drehzahlen revoluciones	<b>3</b>



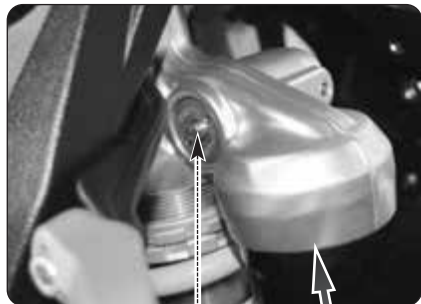

- Dispositivo idraulico di frenatura in compressione
- Compression damping hydraulic device
- Dispositif hydraulique de freinage en compression
- Hydraulische Kompressionsbremse
- Dispositivo hidráulico de frenado en compresión

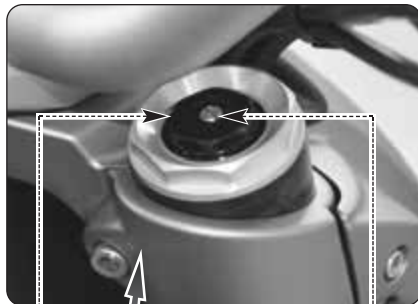

- Precarico molla
- Spring preload
- Précharge du ressort
- Federvorspannung
- Precarga muelle

- Dispositivo idraulico di frenatura in estensione
- Rebound damping hydraulic device
- Dispositif hydraulique de freinage en détente
- Hydraulische Ausdehnungsbremse
- Dispositivo hidráulico de frenado en extensión



- Dispositivo idraulico di frenatura in estensione
- Rebound damping hydraulic device
- Dispositif hydraulique de freinage en détente
- Hydraulische Ausdehnungsbremse
- Dispositivo hidráulico de frenado en extensión

- Precarico molla
- Spring preload
- Précharge du ressort
- Federvorspannung
- Precarga muelle

- Dispositivo idraulico di frenatura in compressione
- Compression damping hydraulic device
- Dispositif hydraulique de freinage en compression
- Hydraulische Kompressionsbremse
- Dispositivo hidráulico de frenado en compresión

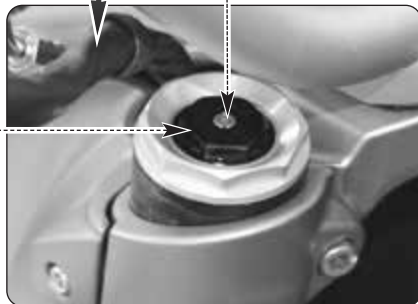
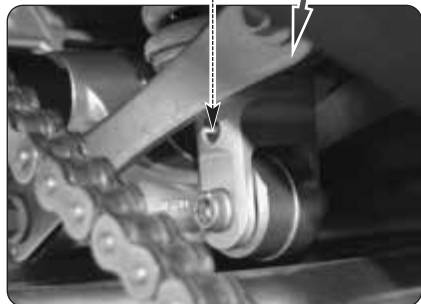

	<b>Brutale 800 RR MY18</b>		<b>Brutale 800 RR Pirelli / RC / LH44</b>	
<b>BRUTALE 800 RR</b>	<b>Tipo di assetto - Type of geometry - Type d'assiette - Einstellungsart - Tipo de equilibrado</b>		<b>Tipo di assetto - Type of geometry - Type d'assiette - Einstellungsart - Tipo de equilibrado</b>	
<b>Sospensione anteriore</b> Front suspension Suspension avant Vordere Federung Suspensión delantera	<b>Su strada - On road - Sur route - Auf Straße - En la carretera</b>		<b>Su strada - On road - Sur route - Auf Straße - En la carretera</b>	
	<b>Solo pilota - Rider only - Avec pilote - Nur Fahrer - Sólo piloto</b>	<b>Con passeggero - With passenger - Avec passager - Mit Beifahrer - Con pasajero</b>	<b>Solo pilota - Rider only - Avec pilote - Nur Fahrer - Sólo piloto</b>	<b>Con passeggero - With passenger - Avec passager - Mit Beifahrer - Con pasajero</b>
<b>Precarico molla</b> Spring preload Précharge du ressort Federvorspannung Precarga muelle	8 giri turns tours Drehzahlen revoluciones	8 giri turns tours Drehzahlen revoluciones	6 giri turns tours Drehzahlen revoluciones	6 giri turns tours Drehzahlen revoluciones
<b>Freno in estensione</b> Rebound damping Frein en détente Ausdehnungsbremse Freno en extensión	2 giri turns tours Drehzahlen revoluciones	2 giri turns tours Drehzahlen revoluciones	2 giri turns tours Drehzahlen revoluciones	2 giri turns tours Drehzahlen revoluciones
<b>Freno in compressione</b> Compression damping Frein en compression Kompressionsbremse Freno en compresión	1 giro turn tour Drehzahl revolución	1 giro turn tour Drehzahl revolución	1 giro turn tour Drehzahl revolución	1 giro turn tour Drehzahl revolución
<b>Ammortizzatore di sterzo</b> Steering vibration damper Amortisseur de direction Steuerungsdämpfer Amortiguador de dirección	<b>Su strada - On road - Sur route - Auf Straße - En la carretera</b>		<b>Su strada - On road - Sur route - Auf Straße - En la carretera</b>	
	<b>Solo pilota - Rider only - Avec pilote - Nur Fahrer - Sólo piloto</b>	<b>Con passeggero - With passenger - Avec passager - Mit Beifahrer - Con pasajero</b>	<b>Solo pilota - Rider only - Avec pilote - Nur Fahrer - Sólo piloto</b>	<b>Con passeggero - With passenger - Avec passager - Mit Beifahrer - Con pasajero</b>
	8 scatti clicks emboîtements Rasten disparos	8 scatti clicks emboîtements Rasten disparos	8 scatti clicks emboîtements Rasten disparos	8 scatti clicks emboîtements Rasten disparos
<b>Sospensione posteriore</b> Rear suspension Suspension arrière Hintere Federung Suspensión trasera	<b>Su strada - On road - Sur route - Auf Straße - En la carretera</b>		<b>Su strada - On road - Sur route - Auf Straße - En la carretera</b>	
	<b>Solo pilota - Rider only - Avec pilote - Nur Fahrer - Sólo piloto</b>	<b>Con passeggero - With passenger - Avec passager - Mit Beifahrer - Con pasajero</b>	<b>Solo pilota - Rider only - Avec pilote - Nur Fahrer - Sólo piloto</b>	<b>Con passeggero - With passenger - Avec passager - Mit Beifahrer - Con pasajero</b>
<b>Frenatura in estensione</b> Rebound damping Freinage en détente Ausdehnungsbremse Freno en extensión	1,5 giri turns tours Drehzahlen revoluciones	1,5 giri turns tours Drehzahlen revoluciones	1,5 giri turns tours Drehzahlen revoluciones	1,5 giri turns tours Drehzahlen revoluciones
<b>Frenatura in compressione</b> Compression damping Freinage en compression Kompressionsbremse Freno en compresión	3 giri turns tours Drehzahlen revoluciones	3 giri turns tours Drehzahlen revoluciones	1,5 giri turns tours Drehzahlen revoluciones	1,5 giri turns tours Drehzahlen revoluciones



*SERVIZIO CLIENTI*  
*CUSTOMER CARE*

**ITALIA N° VERDE: 800-36.44.06**  
**ABROAD: +39 0332 254.724**